

EDSMF2181IB
13468049

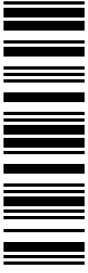

Communication Manual

ModemCAN

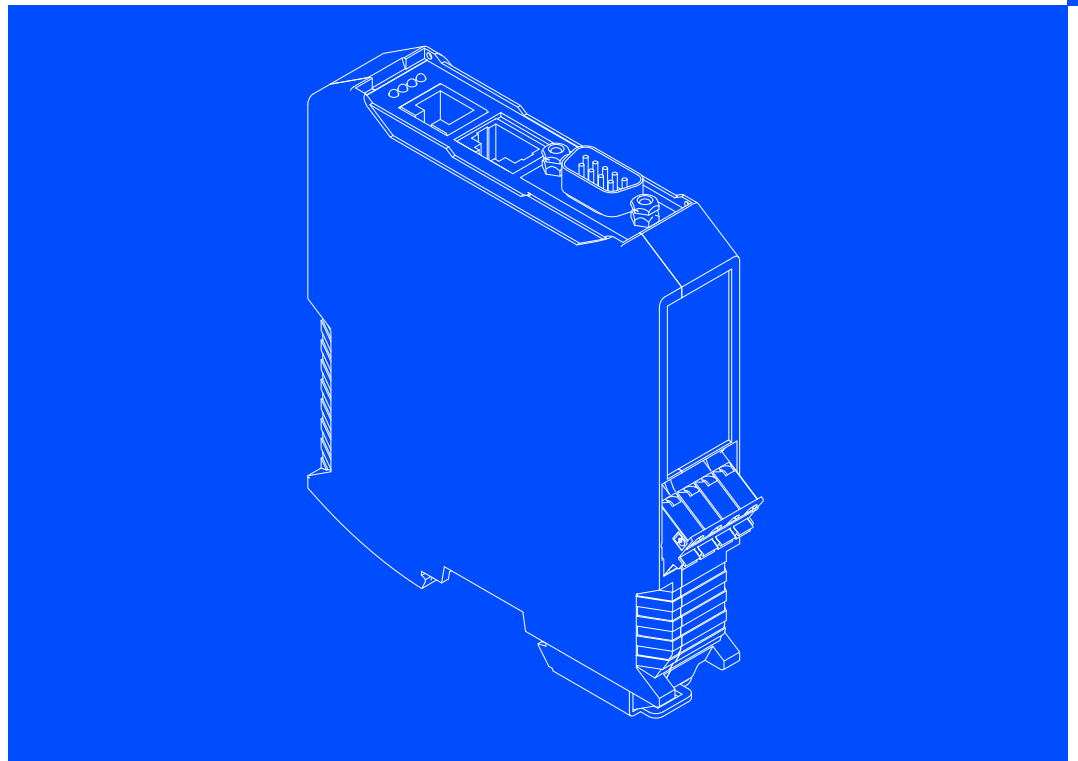

EMF2181IB

Communication module

Lenze

1	About this documentation	4
1.1	Document history	5
1.2	Your opinion is important to us	5
1.3	Legal regulations	6
2	Safety instructions	8
2.1	General safety information	8
2.2	Device- and application-specific safety instructions	9
2.3	Residual hazards	9
2.4	Notes used	10
3	Product description	11
3.1	Controls and displays	11
3.2	Identification	13
3.3	Product features	14
4	Technical data	15
4.1	General data and operating conditions	15
4.2	Protective insulation	16
4.3	Dimensions	17
5	Installation	18
5.1	Mechanical installation	19
5.2	Electrical installation	20
5.2.1	Wiring according to EMC (CE-typical drive system)	20
5.2.2	Communication via CAN	21
5.2.3	Communication via the diagnostic interface (9400)	22
5.2.4	Voltage supply	23
5.2.5	Connection for the CAN bus	24
5.2.6	Connection for an external modem	28
5.2.7	Telephone connection	29
5.2.8	Diagnostic interface	30
6	Commissioning	31
6.1	Before switching on	31
6.2	Commissioning with the system bus configurator	32
6.3	Configuring the communication module	35
6.4	Initial switch-on	38

7	Data transfer	41
7.1	Data transfer via CAN	41
7.2	Data transfer via the diagnostic interface	43
7.3	Data transfer via modem	44
8	Lenze codes and CANopen objects	45
8.1	Overview	47
8.2	Description of the codes relevant for CAN	48
8.3	Description of the CANopen objects implemented	56
8.4	Description of the general codes	58
8.5	Description of the codes relevant for the modem	60
9	Troubleshooting and fault elimination	65
9.1	Signalling of the CANopen RUN LED and ERROR LED	65
9.1.1	CAN operating mode	65
9.1.2	Operating mode - diagnostic interface	66
10	Appendix	67
10.1	Modem standards	67
10.2	List of countries	68
10.3	AT commands	70
10.3.1	General modem control commands	70
10.3.2	Interface commands for the DEE modem	72
10.3.3	Call control commands	73
10.3.4	Modulation control commands	75
10.3.5	Data compression commands	78
10.3.6	S-register	79
11	Index	80

1 About this documentation

1 About this documentation

Target group

This manual is intended for all persons who install, commission and maintain the networking and remote service of a machine.

Contents

The manual exclusively contains descriptions for the EMF2181IB communication module (ModemCAN) and software for remote maintenance.

The manual supplements the mounting instructions which are part of the scope of supply.

The features and functions of the communication module are described in detail.

Typical applications are explained with the help of examples.

The manual does not describe a third-party manufacturer's software. No responsibility is taken for corresponding information given in this manual. Information on how to use the software can be obtained from the documents of the master computer (master).

The theoretical connections are only explained in so far as they are necessary for comprehending the function of the communication module.

Validity information

This documentation is valid for:

Communication module	Type designation	from hardware version	from software version
ModemCAN	EMF2181IB	1x	1x

These instructions are only valid together with the documentation for the standard devices permitted for the application.

1.1 Document history

Edition date	Chapters revised	Notes
11 / 2004	-	First edition
03 / 2005	6.5.2	Update of system bus configurator V1.2
	6.7	Lenze codes supplemented
07 / 2014	All	General corrections



Tip!

Information and tools concerning the Lenze products can be found in the download area under www.lenze.com

1.2 Your opinion is important to us

These instructions were created to the best of our knowledge and belief to give you the best possible support for handling our product.

If you have suggestions for improvement, please e-mail us to:

feedback-docu@Lenze.de

Thank you for your support.

Your Lenze documentation team

1 About this documentation

Legal regulations

1.3 Legal regulations

Labelling

Lenze communication modules are unambiguously designated by the contents of the nameplate.

Manufacturer

Lenze Automation GmbH, Postfach 10 13 52, D-31763 Hameln

CE conformity

In conformity with EC "Low Voltage" Directive

Application as directed

The communication module or function module

- ▶ must only be actuated under the operating conditions described in this communication manual.
- ▶ is an accessory module that is used as an option for the Lenze inverters or Lenze drive PLCs. Detailed information about the application range can be found in the "General" chapter.
- ▶ must be mounted and electrically connected so that when it is installed correctly and is used for application as directed in error-free operation it fulfils its function and does not cause any danger to persons.

Observe all notes in the "Safety instructions" chapter.

Observe all notes relating to the corresponding communication module or function module in this communication manual. This means:

- ▶ Before starting any work, carefully read this part of the communication manual.
- ▶ Always keep the communication manual next to the communication module or function module during operation.

Any other use shall be deemed inappropriate!

Liability

The information, data and notes presented in this communication manual were up to date at the time of printing. No claims to changes of previously delivered communication modules or function modules can be made based on the information, figures and descriptions used in this manual.

The specifications, processes, and circuitry described in this communication manual are for guidance only and must be adapted to your own application. Lenze does not take responsibility for the suitability of the process and circuit proposals.

The information in this communication manual describes the features of the products without guaranteeing them.

Lenze does not accept any liability for damage and malfunctions caused by:

- ▶ Disregarding the communication manual
- ▶ Unauthorised changes to the communication module or function module
- ▶ Operating errors
- ▶ Improper working on and with the communication module or function module

Warranty

See terms of sales and delivery of the Lenze Drive Systems GmbH.

Warranty claims must be made to Lenze immediately after detecting the deficiency or fault.

The warranty is void in all cases where liability claims cannot be made.

Disposal

Material	Recycle	Dispose
Metal	●	-
Plastic	●	-
Assembled PCBs	-	●
Short instructions/operating instructions	●	-

2 Safety instructions



Note!

It is absolutely vital that the stated safety measures are implemented in order to prevent serious injury to persons and damage to material assets.

Always keep this documentation to hand in the vicinity of the product during operation.

2.1 General safety information



Danger!

Disregarding the following basic safety measures may lead to severe personal injury and damage to material assets!

- ▶ Lenze drive and automation components ...
 - ... must only be used for the intended purpose.
 - ... must never be operated if damaged.
 - ... must never be subjected to technical modifications.
 - ... must never be operated unless completely assembled.
 - ... must never be operated without the covers/guards.
 - ... can - depending on their degree of protection - have live, movable or rotating parts during or after operation. Surfaces can be hot.
- ▶ For Lenze drive components ...
 - ... only use permitted accessories.
 - ... only use original manufacturer spare parts.
- ▶ All specifications of the corresponding enclosed documentation must be observed.
This is vital for a safe and trouble-free operation and for achieving the specified product features.
The procedural notes and circuit details provided in this document are proposals which the user must check for suitability for his application. The manufacturer does not accept any liability for the suitability of the specified procedures and circuit proposals.
- ▶ Only qualified skilled personnel are permitted to work with or on Lenze drive and automation components.
According to IEC 60364 or CENELEC HD 384, these are persons ...
 - ... who are familiar with the installation, assembly, commissioning and operation of the product,
 - ... possess the appropriate qualifications for their work,
 - ... and are acquainted with and can apply all the accident prevent regulations, directives and laws applicable at the place of use.

2.2 Device- and application-specific safety instructions

- ▶ During operation, the communication module must be securely connected to the standard device.
- ▶ With external voltage supply, always use a separate power supply unit, safely separated in accordance with EN 61800-5-1 in every control cabinet (SELV/PELV).
- ▶ Only use cables that meet the given specifications. (📖 24)



Documentation of the standard device, control system, and plant/machine

All the other measures prescribed in this documentation must also be implemented. Observe the safety instructions and application notes contained in this manual.

2.3 Residual hazards

Protection of persons

- ▶ If inverters are connected to phase-earthed system with a rated mains voltage ≥ 400 V, external measures need to be implemented to provide reliable protection against accidental contact. (see chapter "4.2", 📖 16)

Device protection

- ▶ The communication module contains electronic components that can be damaged or destroyed by electrostatic discharge.

2.4 Notes used

The following pictographs and signal words are used in this documentation to indicate dangers and important information:

Safety instructions

Structure of safety instructions:

**Danger!**

(characterises the type and severity of danger)

Note

(describes the danger and gives information about how to prevent dangerous situations)

Pictograph and signal word	Meaning
Danger!	Danger of personal injury through dangerous electrical voltage. Reference to an imminent danger that may result in death or serious personal injury if the corresponding measures are not taken.
Danger!	Danger of personal injury through a general source of danger. Reference to an imminent danger that may result in death or serious personal injury if the corresponding measures are not taken.
Stop!	Danger of property damage. Reference to a possible danger that may result in property damage if the corresponding measures are not taken.

Application notes

Pictograph and signal word	Meaning
Note!	Important note to ensure troublefree operation
Tip!	Useful tip for simple handling
	Reference to another documentation

3 Product description

3.1 Controls and displays

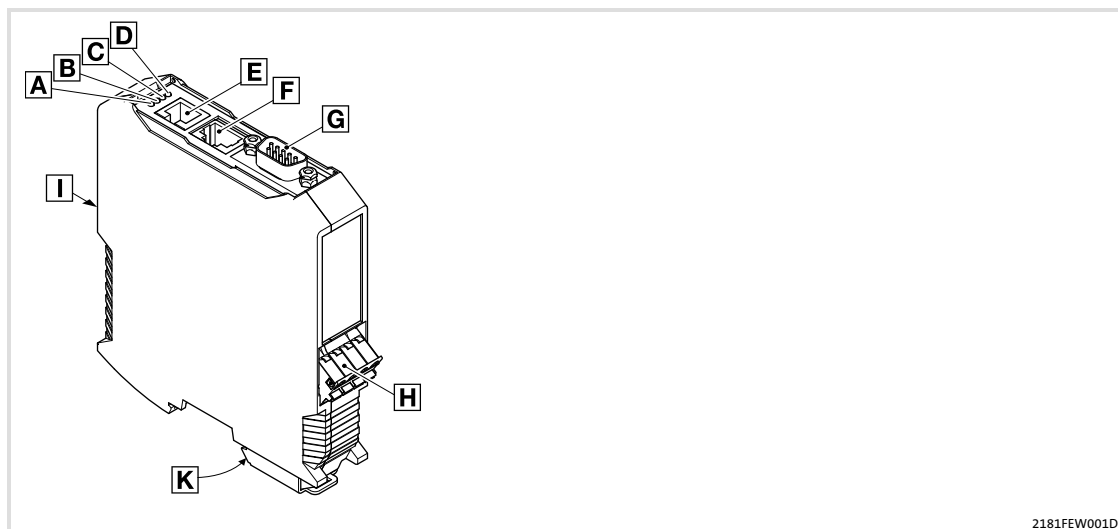



Fig. 3-1 Communication module ModemCAN 2181

Connections

Pos.	Name	Description
E	Telephone connection	Socket (RJ11)
F	Connection at diagnostic interface of the Servo Drive 9400	Socket (RJ69)
G	CAN connection	Socket (RS232, male)
H	Connection for voltage supply	Terminal strip with spring connection, 4-pole
I	External modem connection	Socket (RS232, male)
K	PE connection	The plugged communication module is automatically connected to the DIN rail. The DIN rail must be connected with PE!

LED status displays

Pos.	Colour	State	Description
A (M)	yellow	on	The ModemCAN 2181 is ready for operation.
		blinking	Active communication over the telephone network
B (E)	red	on	<ul style="list-style-type: none"> Operation via the diagnostic interface: No device is connected to the diagnostic interface.
		see  40	<ul style="list-style-type: none"> Operation via CAN: ERR LED
C (R)	green	on	<ul style="list-style-type: none"> Operation via the diagnostic interface: A device is connected to the diagnostic interface.
		see  40	<ul style="list-style-type: none"> Operation via CAN: RUN-LED
D (P)	green	on	The ModemCAN 2181 is supplied with voltage.



Note!

Refer to the instructions on the signals provided by the ERROR LED and RUN LED in the Troubleshooting chapter ( 65).

3.2 Identification

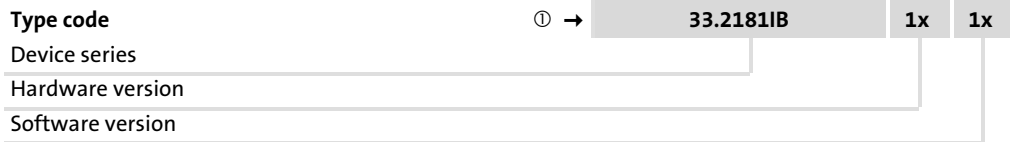
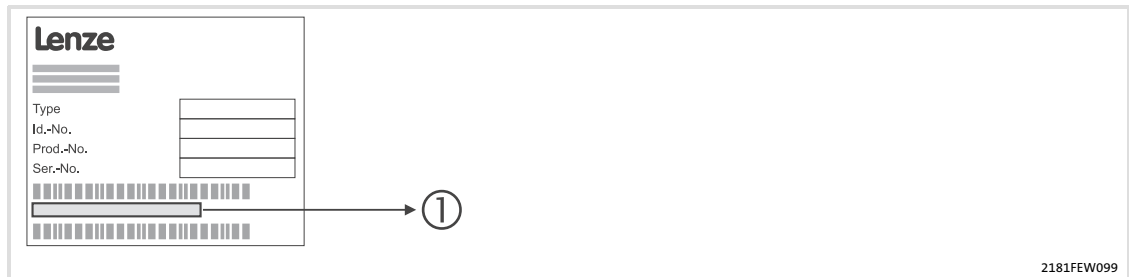

3.3 Product features

The communication module is used for setting parameters during remote maintenance or for programming and commissioning the applicable Lenze devices.

The ModemCAN 2181 communication module makes it possible to directly couple a CAN bus to an analog telephone line. It is equipped with an internal analog modem which is approved for all internationally relevant countries and telephone standards and thus enables worldwide remote maintenance. If required, an external modem can be connected if the internal modem is not suitable in the respective country, or if a GSM or ISDN modem is required.

**Note!**

We continuously strive to ensure the highest level of compatibility between the ModemCAN 2181 and other modems. However, full compatibility cannot be reached because of the great variety of modems available on the market. If communication with the internal modem cannot be established, a suitable external modem has to be used.

Application range

The communication module can be used with the following Lenze devices:

- ▶ Servo Drives 9400
- ▶ Inverter Drives 8400
- ▶ 9300 servo inverter
- ▶ 9300 vector
- ▶ 9300 Servo PLC
- ▶ ECS servo system
- ▶ 8200 motec motor inverter
- ▶ 8200 vector frequency inverter
- ▶ 82XX frequency inverter
- ▶ Drive PLC
- ▶ Terminal extension 9374
- ▶ Control / display unit (EPM-HXXX)
- ▶ I/O system IP20 (EPM-TXXX)

The internal modem supports a series of international specifications and standards.

If the internal modem cannot be used, it is possible to connect an external modem using the RS232 interface.

4 Technical data

4.1 General data and operating conditions

Range	Values
Order designation	EMF2181IB
Communication media (system)	CAN (DIN ISO 11898) Lenze diagnostic interface
Communication media (external)	Telephone analogue, 33.6 kbit/s, (V34)
Number of nodes at the CAN bus	Max. 100
Baud rate	<ul style="list-style-type: none"> • when communicating via CAN <ul style="list-style-type: none"> – 20 kbit/s – 50 kbit/s – 125 kbit/s – 250 kbit/s – 500 kbit/s – 1000 kbit/s • For communication via diagnostic interface <ul style="list-style-type: none"> – 230.4 kbit/s
Voltage supply (external) via separate power supply	18 ... 30 V DC, max. 100 mA (in accordance with EN 61131-2)

Conformity and approval

Conformity

CE	2004/108/EC	EMC Directive	
EAC	TP TC 020/2011 (TR CU 020/2011)	Electromagnetic compatibility of technical means	Eurasian Conformity TR CU: Technical Regulation of Customs Union
EAC	TP TC 004/2011 (TR CU 004/2011)	On safety of low voltage equipment	Eurasian Conformity TR CU: Technical Regulation of Customs Union

Operating conditions	Values	Deviations from the standard
Climatic conditions		
Storage	1 K3 to IEC/EN 60721-3-1	- 10 ... + 60 °C
Transport	2 K3 acc. to IEC/EN 60721-3-2	- 10 ... + 70 °C
Operation	3 K3 acc. to IEC/EN 60721-3-3	0 ... + 60 °C
Enclosure of attached module	IP20	
Degree of pollution	2 acc. to IEC/EN 61800-5-1	

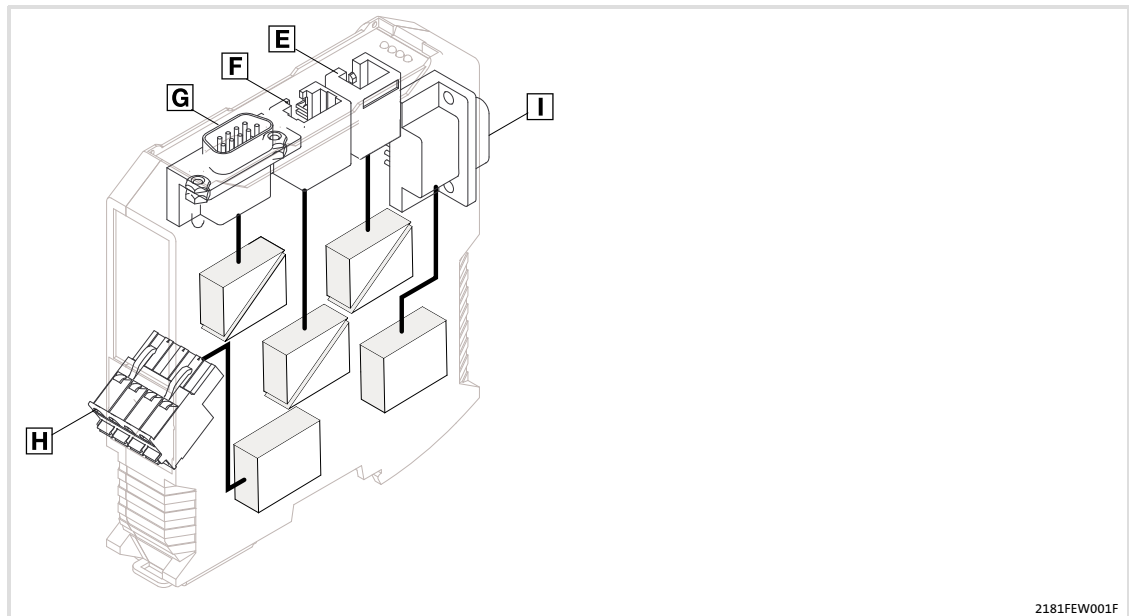

2181FEW001F

Connection		Type of insulation (according to EN 61800-5-1)
E	Telephone	Functional insulation
F	Diagnostic interface	Functional insulation
G	CAN bus	Functional insulation
H	Voltage supply	No insulation
I	External modem	No insulation

4.3 Dimensions

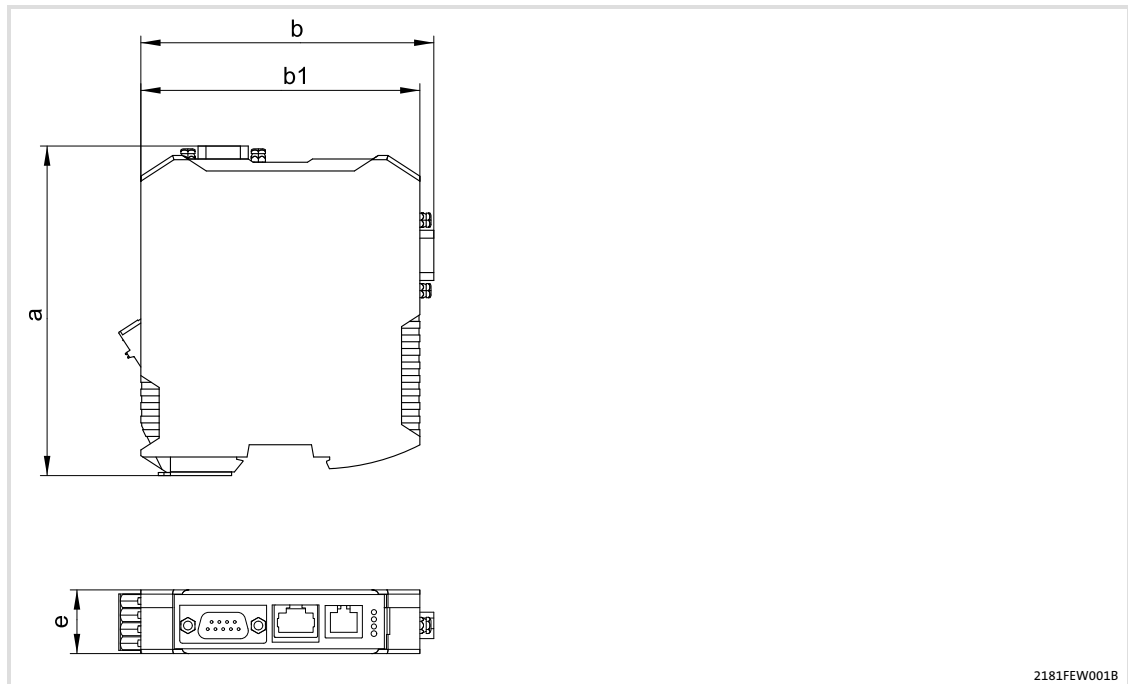

A	117 mm
B	103 mm
b1	99 mm
E	22.5 mm



Danger!

Inappropriate handling of the communication module and the standard device can cause serious personal injury and material damage.

Observe the safety instructions and residual hazards described in the documentation for the standard device.



Stop!

The device contains components that can be destroyed by electrostatic discharge!

Before working on the device, the personnel must ensure that they are free of electrostatic charge by using appropriate measures.

5.1 Mechanical installation

Mounting

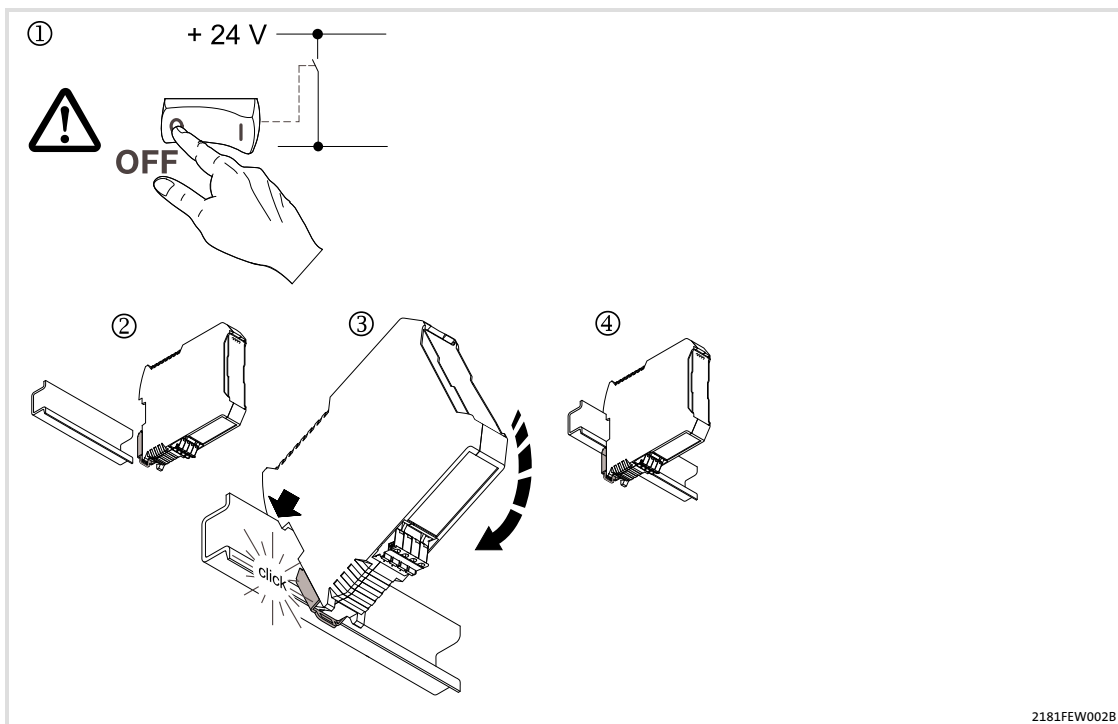

Fig. 5-1 Snap communication module to DIN rail

Dismounting

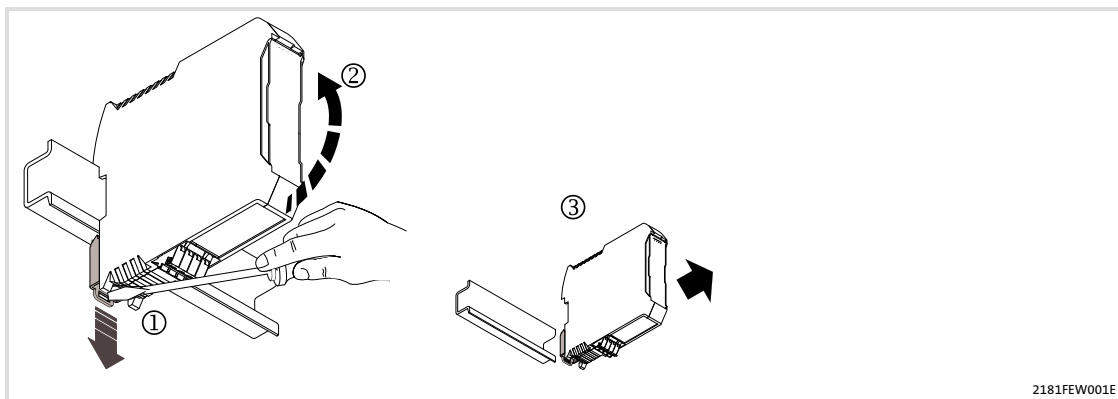

Fig. 5-2 Unlock communication module ① and lift off DIN rail ②.

5.2 Electrical installation**5.2.1 Wiring according to EMC (CE-typical drive system)**

For wiring according to EMC requirements observe the following points:

**Note!**

- ▶ Separate control cables/data lines from motor cables.
- ▶ Connect the shields of control cables/data lines *at both ends* in the case of digital signals.
- ▶ Use an equalizing conductor with a cross-section of at least 16 mm² (reference: PE) to avoid potential differences between the bus nodes.
- ▶ Observe the other notes concerning EMC-compliant wiring given in the documentation for the standard device.

Wiring procedure

1. Comply with bus topology, thus do not use stubs.
2. Observe notes and wiring instructions in the documents for the control system.
3. Only use cables that comply with the given specifications (📖 24).
4. Observe notes for the voltage supply of the module (📖 23).

5.2.2 Communication via CAN

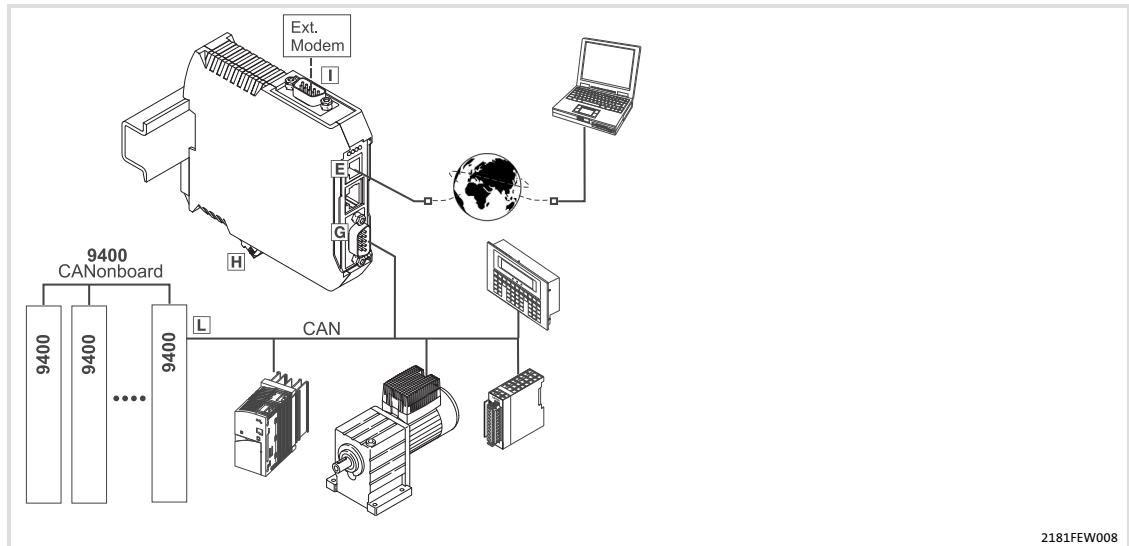

Fig. 5-3 Communication via the CAN bus

Installation steps

Step	Description	Connection (see graphics)	Additional information
1.	Plug the Sub-D plug (EWZ0046) into the ModemCAN 2181.	G	24
2.	If it's not possible to use the internal modem, connect an external modem.	I	28
3.	Connect the inverter to the CAN bus.	L	-
4.	Connect the ModemCAN 2181 to the telephone network.	E	29
5.	Connect the voltage supply to the plug connector.	H	23

5.2.3

Communication via the diagnostic interface (9400)

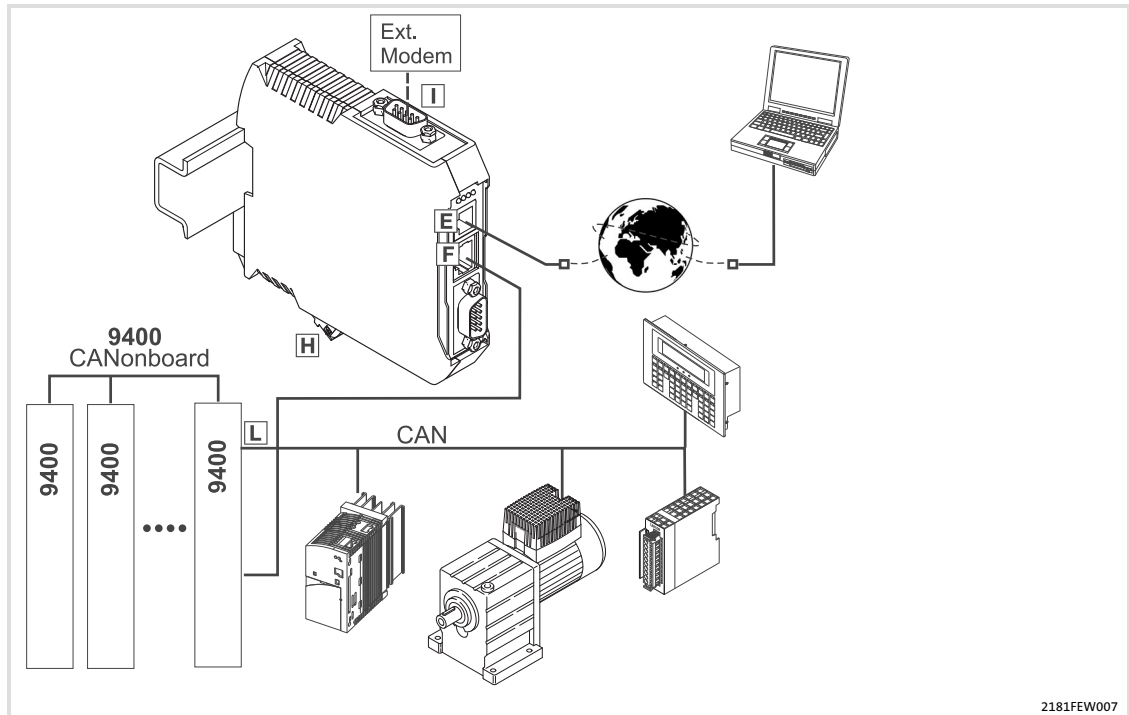

Fig. 5-4 Communication via the diagnostic interface (only 9400)

Installation steps

Step	Action	Connection (see graphics)	Additional information
1.	Connect voltage supply to the plug connector	H	📖 23
2.	Connect diagnostic interface to the 9400 inverter (use pre-assembled cable)	F	📖 30
3.	If it's not possible to use the internal modem, connect an external modem.	I	📖 28
4.	Connect inverter to CAN bus	L	-
5.	Connect ModemCAN 2181 to telephone network	E	📖 29

We especially recommend carrying out communication via the diagnostic interface if the 2181 communication module is only connected temporarily.

In the case of a fixed installation, communication via CAN is preferable, see (📖 21).



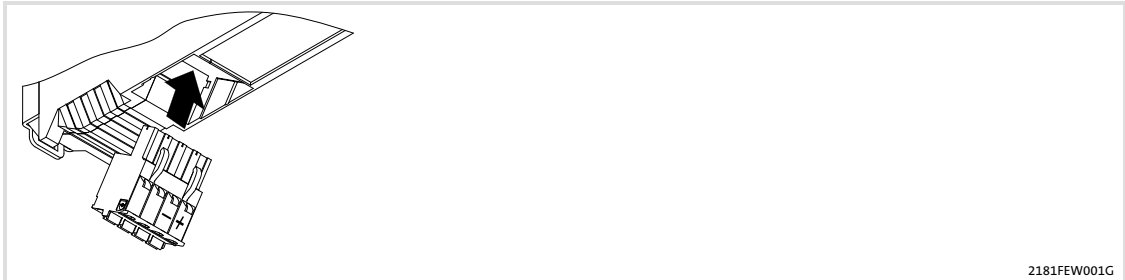

5.2.4 Voltage supply

Terminal data



2181FEW001G

Terminal data

Electrical connection	Plug connector with spring connection	
Possible connections		rigid: 2.5 mm ² (AWG 12)
	flexible:	
		without wire end ferrule 2.5 mm ² (AWG 12)
		with wire end ferrule, without plastic sleeve 2.5 mm ² (AWG 12)
		with wire end ferrule, with plastic sleeve 2.5 mm ² (AWG 12)
Stripping length	10 mm	

Handling of pluggable terminal strips



Stop!

In order to avoid damages to the pluggable terminal strips and the contacts:

- ▶ The terminal strips must be wired before plugging them in!
- ▶ Pluggable terminals strips that are not assigned must be plugged on as well.

Use of pluggable terminal strip with spring connection

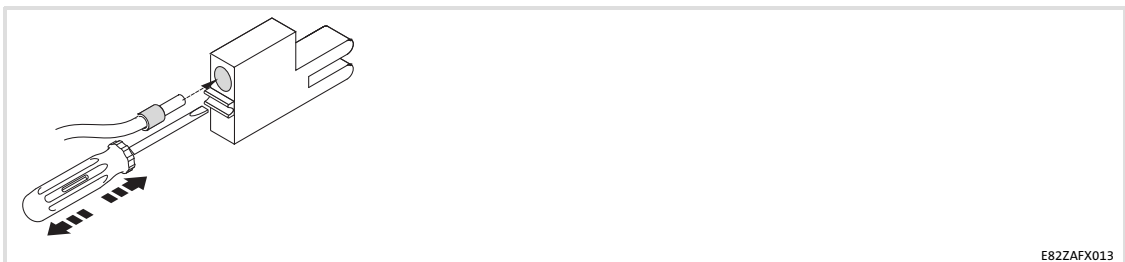

E82ZAFX013

5.2.5 Connection for the CAN bus

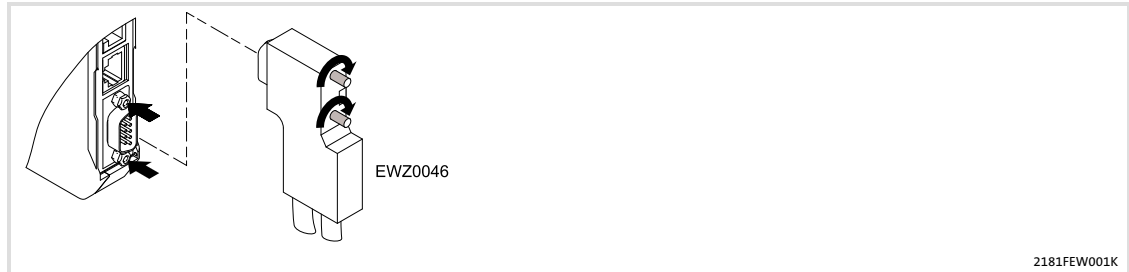

2181FEW001K

Assignment of the Sub-D plug connector

View	Pin	Assignment
	1, 4, 5, 6, 8, 9	-
	2	CAN-LO
	3	CAN-GND
	7	CAN-HI

Between CAN_LOW and CAN-HIGH the CAN bus has to be terminated by resistors (120 Ω). The Sub-D plug with an integrated terminating resistor (order no. EWZ0046, not included in the scope of supply) complies with the recommendation DS 102-1 of CiA.

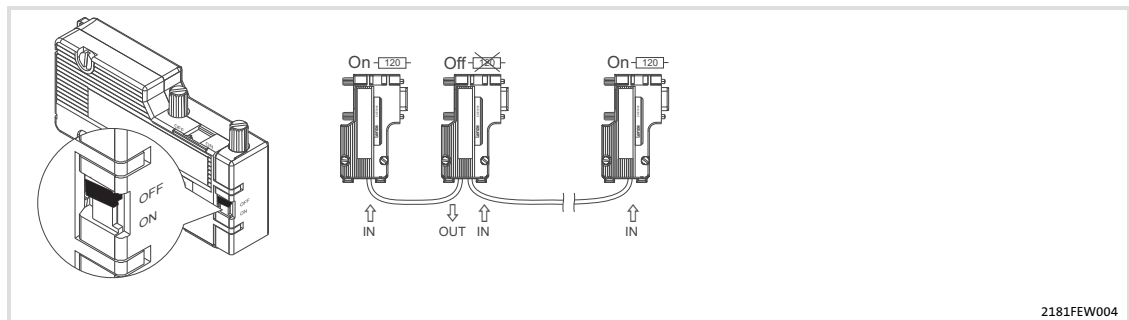

2181FEW004

Specification of the transmission cable

We recommend the use of CAN cables in accordance with ISO 11898-2:

CAN cable in accordance with ISO 11898-2	
Cable type	Paired with shielding
Impedance	120 Ω (95 ... 140 Ω)
Cable resistance/cross-section	
	Cable length ≤ 300 m ≤ 70 mΩ/m / 0.25 ... 0.34 mm ² (AWG22)
	Cable length 301 ... 1000 m ≤ 40 mΩ/m / 0.5 mm ² (AWG20)
Signal propagation delay	≤ 5 ns/m

Bus cable length



Note!

- ▶ It is absolutely necessary to comply with the permissible cable lengths.
- ▶ Please note the reduction of the total cable length due to the signal delay of the repeater (📖 27).
- ▶ Mixed operation
 - Mixed operation refers to different nodes which are connected to the same network.
 - If the total cable lengths of the nodes are different at the same baud rate, the smaller value must be used to determine the max. cable length.

1. Please check the compliance with the total cable length in Tab. 5-1.

The total cable length is determined by the baud rate.

Baud rate [kbit/s]	Max. bus length [m]
10	8000
20	3900
50	1500
125	630
250	290
500	110
800	40
1000	17

Tab. 5-1 Total cable length

2. Please check the compliance with the segment cable length in Tab. 5-2.

The segment cable length is specified by the cable cross-section and the number of nodes. Without a repeater, the segment cable length corresponds to the total cable length.

Max. number of nodes per segment	Cable cross-section			
	0.25 mm ²	0.5 mm ²	0.75 mm ²	1.0 mm ²
2	240 m	430 m	650 m	940 m
5	230 m	420 m	640 m	920 m
10	230 m	410 m	620 m	900 m
20	210 m	390 m	580 m	850 m
32	200 m	360 m	550 m	800 m
63	170 m	310 m	470 m	690 m
100	150 m	270 m	410 m	600 m

Tab. 5-2 Segment cable length

3. Compare both values.

If the value given in Tab. 5-2 is smaller than the total cable length given in Tab. 5-1, repeaters must be used. Repeaters divide the total cable length into segments.

Example: Selection help**Given:**

- Cable cross-section: 0.5 mm² (according to cable specification ☐ 24)
- Number of nodes: 128
- Repeater: Lenze repeater, type 2176 (cable reduction: 30 m)

At maximum number of nodes (128), the following cable lengths/number of repeaters must comply with:

Baud rate [kbit/s]	10	20	50	125	250	500	800	1000
Max. cable length [m]	8000	3900	1500	630	290	110	40	17
Segment cable length [m]	270	270	270	270	270	110	40	17
Number of repeaters	33	16	6	2	1	-		-

Check repeater application

Given:

- | | |
|------------------------|---------------------|
| • Baud rate: | 125 kbit/s |
| • Cable cross-section: | 0.5 mm ² |
| • Number of nodes: | 28 |
| • Cable length: | 450 m |

Test sequence	Cable length	See
1. Total cable length at 125 kbit/s:	630 m	Tab. 5-1
2. Segment cable length for 28 nodes and a cable cross-section of 0.5 mm ² :	360 m	Tab. 5-2
3. Comparison: The value under point 2 is smaller than the required cable length of 450 m.		

Conclusion

- It is not possible to use a cable length of 450 m without installing a repeater.
- After 360 m (point 2) a repeater must be installed.

Result

- The Lenze repeater, type 2176 (cable reduction: 30 m), is used.
- Calculation of the max. cable length:
First segment: 360 m
Second segment: 360 m (according to Tab. 5-1) *minus* 30 m (cable reduction when a repeater is used)
→ Max. possible cable length with repeater: 690 m.
→ Now the required cable length is possible.



Note!

The use of a further repeater is recommended as a

► Service interface

Advantage: Trouble-free connecting during ongoing bus operation is possible.

► Calibration interface

Advantage: Calibration/programming unit remains electrically isolated.

5.2.6 Connection for an external modem**Assignment of the RS232 interface**

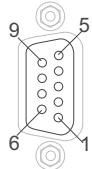
View	Pin	Designation		Signal	Signal name	Direction
		V.24	RS232			
	1	109	CF	DCD	Data Carrier Detector	Output
	2	104	bb	RD	Data	Output
	3	103	BA	TD	Transmitted Data	Input
	4	108/2	CD	DTR	Data Terminal Ready	Input
	5	102	from	SG	Signal Ground	-
	6	107	cc	DSR	Data Set Ready	Output
	7	105	CA	RTS	Request To Send	Input
	8	106	CB	CTS	Clear To Send	Output
	9	125	CE	-	Ring Indicator	Output

5.2.7 Telephone connection

Assignment of the telephone socket

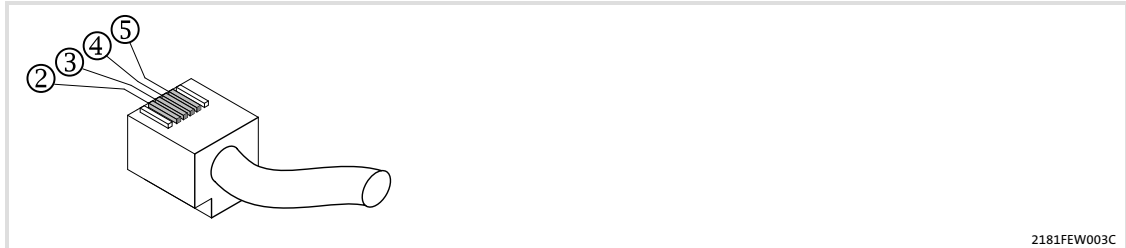

2181FEW003C

Pin	Designation
2	not assigned
3	L _a (TIP)
4	L _b (RING)
5	not assigned

Worldwide, the telephone sockets differ from each other. For the most important standards, the following cables are supplied with the product:

TAE connecting cable

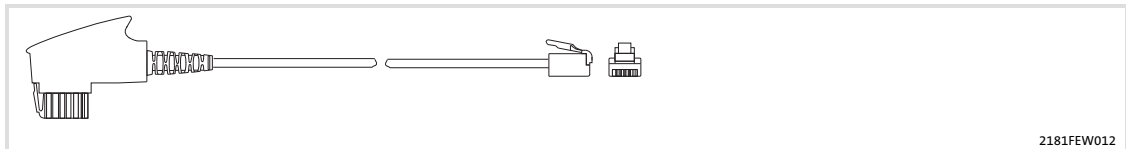

2181FEW012

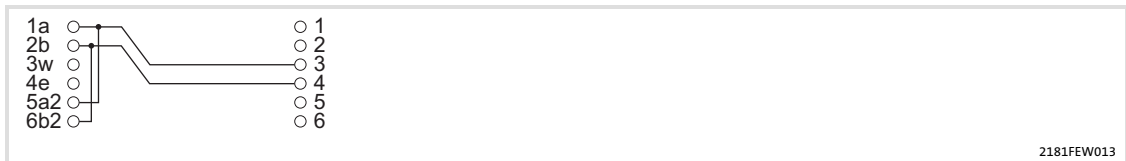

2181FEW013

Fig. 5-5 Terminal assignment TAE-N plug and RJ11 plug (6p/4c)

Modular connecting cable

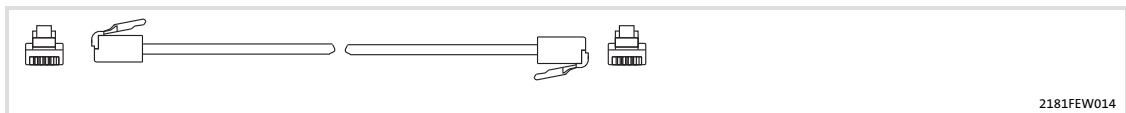

2181FEW014

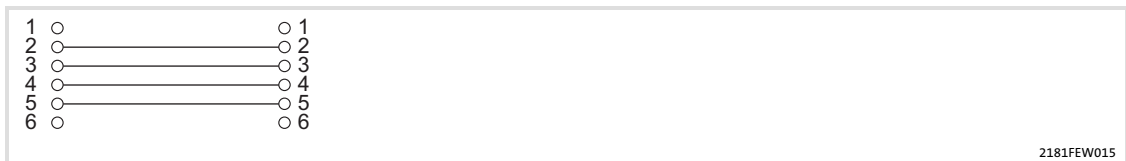

2181FEW015

Fig. 5-6 Terminal assignment of the two RJ11 plugs (6p/4c)

5.2.8

Diagnostic interface**Note!**

Please use only prefabricated cable.

Assignment of the diagnostic connector

Pin	Name	Signal
1	+UB18_DIAG	Supply (keypad, PC coupler)
2	RTS+	Handshake, basic device - diagnostic device
3	RTS-	
4	Tx+	Data, basic device - diagnostic device
5	Tx-	
6	Rx+	Data, diagnostic device - basic device
7	Rx-	
8	CTS+	Handshake, diagnostic device - basic device
9	CTS-	
10	GND	Supply (keypad, PC coupler)
Housing	Shielding	Shielding (connected to metal housing)

6 Commissioning

6.1 Before switching on



Stop!

Prior to switching on the mains voltage, check the wiring for completeness, short-circuit and earth fault.

Automatic address assignment and automatic detection of the baud rate

The device is equipped with the following functions:

- ▶ Automatic address assignment
- ▶ Automatic detection of the baud rate

Both functions are used to prevent malfunctions in operation due to incorrectly set user addresses and baud rate.



Note!

In default setting these functions are not activated.

Please refer to the related instructions on the codes

- ▶ C0350: "General address assignment" (📖 48)
- ▶ C0351: "Set baud rate" (📖 49)

Configuring the country-specific code

Before the 2181 communication module is connected to the telephone network, it may be required to configure the country-specific code.



Note!

Observe the description for code C1208 (📖 63).

**Note!**

A window-compatible modem must be installed in the windows system control.

The communication is executed via the TAPI interface.

System requirements

The following minimum requirements of hardware and software must be met to work with the communication module:

- ▶ Microsoft® Windows® 2000/XP
- ▶ IBM®-compatible PC with Intel® Pentium®-266 processor or higher
- ▶ 128 MB main memory with Windows 2000/XP

Available Lenze programs

The following Lenze programs allow for a communication via the communication module :

- ▶ Drive Server
- ▶ Global Drive Control (GDC version 4.7 or higher)
- ▶ Global Drive Loader
- ▶ Global Drive PLC Developer Studio (DDS version 1.4 or higher)
- ▶ L-force Engineer

**Note!**

One of the programs mentioned offer alternative communication paths for CAN. In this case, please always select the communication path "OPC".

Installing the required driver

**Note!**

The driver installation under Windows 2000/XP requires administrator rights!

For a perfect operation of the communication module, install the "CAN" communication software with a \geq version 2.0. It is included in the Lenze programs and is loaded on the PC during the installation.

**Note!**

- ▶ The following program version do not contain the required minimum version of the CAN communication software:
 - Drive Server, version 1.1
 - Global Drive Control, version 4.7
 - Global Drive Loader, version 2.2
 - Global Drive PLC Developer Studio, version 2.2
- ▶ The current communication software can be found in the download area of the Lenze homepage <http://www.Lenze.com>
- ▶ For this purpose proceed the following steps:
 - Save the data of the Lenze homepage to your local hard disk.
 - Install the Lenze programs that will communicate via the 2180 communication module.
 - Install the communication software by following the instructions of the installation program.

System bus configurator

**Note!**

The current version of the CAN communication software is displayed in the information dialogue of the system bus configurator and other Lenze programs.

The Lenze system bus configurator for the comfortable configuration of the communication modules used is installed together with the CAN communication software.

It also serves to establish a dial-up connection with the ModemCAN communication module.

Installation of the diagnostic interface communication configurator

The diagnostic interface communication configurator is installed together with the diagnostic interface communication software. It is used if the connection between the ModemCAN and the inverter is established (📖 21) via the diagnostic interface instead of via CAN. (📖 22) All following notes relating to the system bus configurator also apply to the diagnostic interface communication configurator.

**Note!**

The current version of the CAN communication software is displayed in the information dialog of the "Diagnostic interface communication configurator" and other Lenze programs.

6.3 Configuring the communication module

Before the Lenze tools can communicate via the communication module it must be configured accordingly.

To open the system bus configurator, select the following on the Start menu:

Programs→Lenze→Communication→System bus configurator.

In contrast to other communication modules, the individual parameters are not to be found under the "Settings" tab. Instead, one entry in a telephone directory can be made for each system for which remote maintenance is to be carried out. There also the usual CAN parameters such as the baud rate, parameter channel, and time-out can be found.

Steps to be taken for configuring the communication module

1. Select the communication module from the list in the system bus configurator.
2. Double-click the corresponding line.
3. If you are starting the telephone directory for the first time, some configurations are carried out now and entries for all modems configured on the PC are made.
4. Create an entry in the telephone directory that appears now.
5. Enter the parameters required
6. Enter the user name and password:
 - Standard user: "Lenze"
 - Standard password: "Lenze"
7. Specify the phone number to be called.



Tip!

On some extension systems and in some countries, a pause is required during the dial-up process. Please gather the settings required for this from the documentation of the extension system and the PC modem.

8. Select the modem to be used.
9. Close the settings dialog

Now a first selection of the communication module from the telephone directory can be made.

1. For this purpose, click the "Connect" button. Check the values listed and select "Connect" again.
2. Now a selection and user authentication are carried out.
3. After successful dial-up it is determined whether the CAN parameters configured on the PC are identical to those in the device. If this is not the case, they are adjusted.
4. Then a small status window appears, showing the connection status and the connection time. Via this window, the connection can also be disconnected again.
5. Change to the system bus configurator again, select the "General" tab and click the "Diagnostics" tab. Now the CAN bus can be searched for nodes connected.
6. Confirm the confirmation prompt with "Yes", or select "No" to abort the diagnostics process.

When the communication module has succeeded in communicating with the corresponding bus nodes, the system bus node addresses of the bus nodes found are listed in the "Device status" field.

If the communication module is not able to communicate with the bus nodes, an error message is displayed.

The communication module answers with its CAN address or with "0" if it has no address (depending on C00350 and C1213). The data telegrams for communication with the communication module itself, however, are not visible on the CAN bus.



Note!

Additional information about the configuration of the communication module can be found in the **online help** of the system bus configurator.

After completing the configuration

If the configuration of a communication module has been successfully completed, the Lenze tools can use it for communication.

Only the selection of the bus system used is carried out in the Lenze tools, all system bus-specific settings and the selection of the communication module are carried out exclusively via the system bus configurator.



Note!

While some of the older program versions of the Lenze tools still offer setting options for interrupt and I/O address, they are meaningless in the context of the communication module.

Callback function



Note!

- ▶ After a callback connection has been configured for the first time, the PC must usually be restarted.
- ▶ The use of the callback function requires at least version 2.1 of the CAN communication software.

When the callback function is used, the connection will only be established after the following activities have taken place:

1. The PC calls the communication module.
2. The communication module returns the PC's call under the phone number specified in code C1205.

6.4 Initial switch-on

Signalling

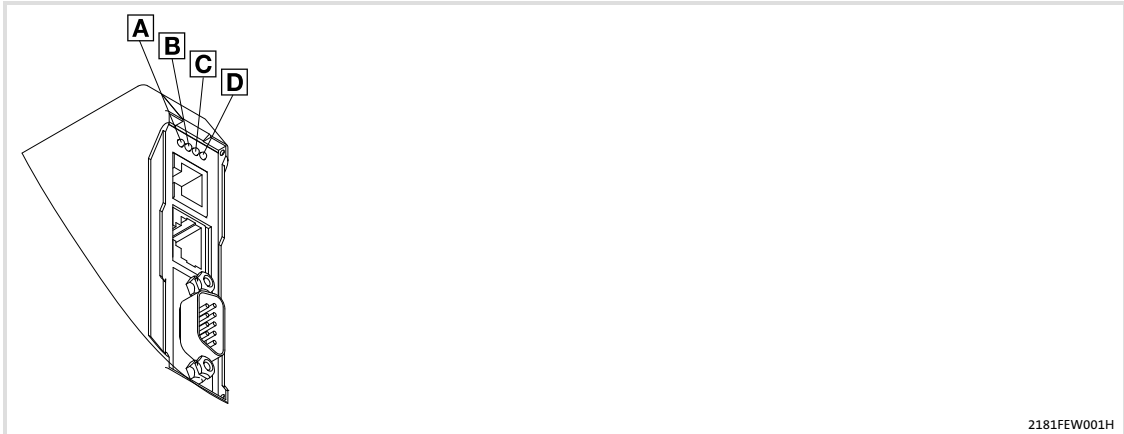

2181FEW001H

Fig. 6-1 Signalling on the front of the communication module

Pos.	Colour	State	Description
A (M)	yellow	on	The ModemCAN 2181 is ready for operation.
		blinking	Active communication over the telephone network
B (E)	red	on	<ul style="list-style-type: none"> Operation via the diagnostic interface: No device is connected to the diagnostic interface.
		see 40	<ul style="list-style-type: none"> Operation via CAN: ERR LED
C (R)	green	on	<ul style="list-style-type: none"> Operation via the diagnostic interface: A device is connected to the diagnostic interface.
		see 40	<ul style="list-style-type: none"> Operation via CAN: RUN-LED
D (P)	green	on	The ModemCAN 2181 is supplied with voltage.

Signalling sequence after switch-on

1. The LED **D** is lit. The communication module is carrying out some internal initialisation processes.
2. Initialisation phase of peripherals starts:
LED **C** (RUN-LED) is lit.
3. The further signalling sequence depends on the operating mode that has been configured with code C1213:

CAN operating mode (C1213 = 0)	Diagnostic interface operating mode (C1213 = 1)
After initialisation of the CAN controller: LED C (RUN-LED) is lit.	After having established communication with inverter: LED C (RUN-LED) is lit.
	If no device is connected: LED B (ERR-LED) is lit.

4. After initialisation of the internal or external modem:
LED **A** is lit.

The device is ready for operation now and can answer calls.

Signalling acc. to DR303-3

Status display (LED)	Explanation
Connection status to the bus with the following signalling:	
off	No connection to the master
green 	CANopen status ("S")
red 	CANopen fault ("F")
Constant red	F: bus off 
Flickering	Automatic detection of the baud rate is active 
Green blinking every 0.2 s	S: pre-operational, F: none 
Green blinking every 0.2 s Red blinking 1 x, 1 s OFF	S: pre-operational, F: warning limit reached 
Green blinking every 0.2 s Red blinking 2 x, 1 s OFF	S: pre-operational, F: node guard event 
Constant green	Z: operational, F: no errors 
Constant green Red blinking 1 x, 1 s OFF	Z: operational, error: warning limit reached 
Constant green Red blinking 2 x, 1 s OFF	Z: operational, F: node guarding event 
Constant green Red blinking 3 x, 1 s OFF	Z: operational, F: sync message error 
Green blinking every 1 s	Z: stopped, F: no errors 
Green blinking every 1 s Red blinking 1 x, 1 s OFF	S: stopped, F: warning limit reached 
Green blinking every 1 s Red blinking 2 x, 1 s OFF	S: stopped, F: node guard event 

Tab. 6-1 Signalling according to DR303-3

7 Data transfer

7.1 Data transfer via CAN

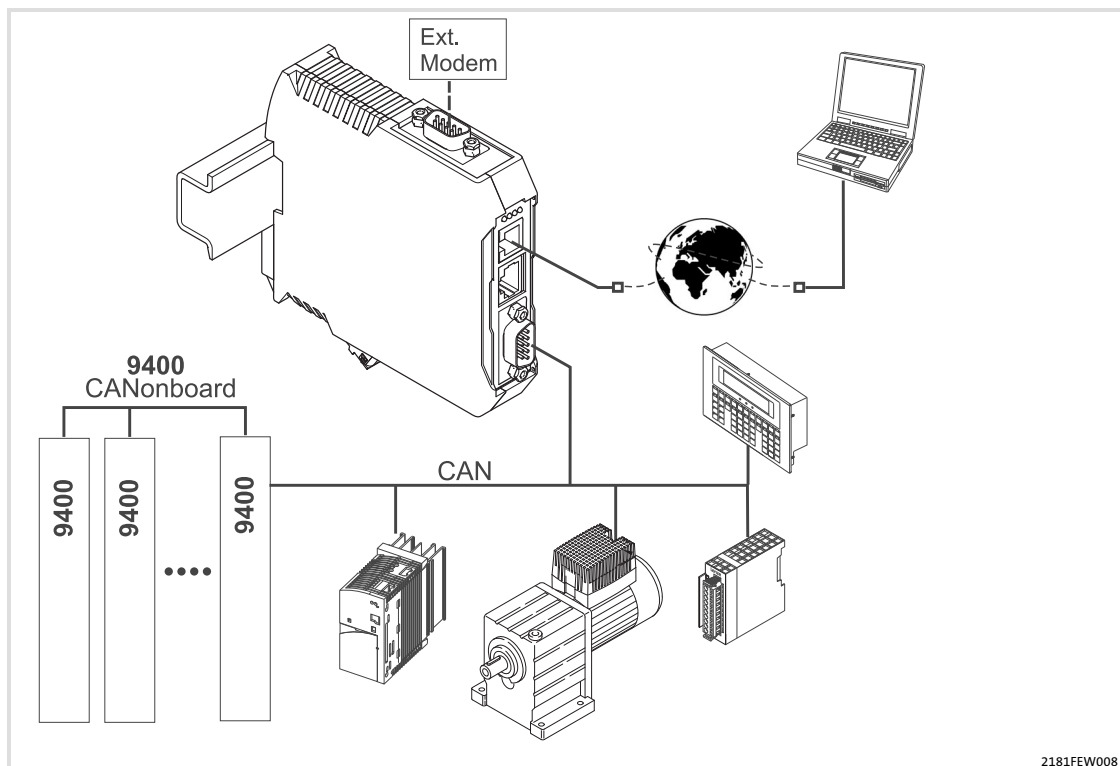

Master and slave communicate with each other by sending data telegrams via the CAN bus. The user data range of a data telegram either contains network management data, *parameter data*, or *process data*.

Different communication channels are assigned to parameter and process data in the inverter.

Apart from the transfer of IEC61131 programs and application data, e.g. profile data, the ModemCAN 2181 communication module is only suitable for the transfer of parameter data.

Parameter data (SDO, service data objects)	Parameter data channel
<p>These are for example</p> <ul style="list-style-type: none"> operating parameters diagnostics information motor data <p>In general, the transfer of parameters is not as time-critical as the transfer of process data.</p>	<ul style="list-style-type: none"> Provide access to all Lenze codes and all CANopen indexes. Changes to parameters are normally stored in the inverter automatically (note C0003).

The structure of the CAN messages is described in the CAN communication manual.

Access to the inverter codes



Note!

For the value range of the Lenze code, please refer to the operating instructions for the inverter (see 'Code list').

When communication modules are used, the properties and the behaviour of a drive controller integrated into the network can be changed by a higher level master (e. g. a PLC).

The parameters to be changed are contained in the codes of Lenze inverters.

The inverter codes are addressed using the index on access via the communication module.

The index for the Lenze code number is in the range between 16576 ($40C0_{\text{hex}}$) and 24575 ($5FFF_{\text{hex}}$).

Conversion formula:

Index [dec] = 24575 - Lenze code number

Indexing of codes using the example

C0001 (operating mode)

dec	hex
Index = 24575 - Lenze code	$\text{Index}_{\text{hex}} = 5FFF_{\text{hex}} - (\text{Lenze code})_{\text{hex}}$
Index = 24575 - 1 = 24574	$\text{Index}_{\text{hex}} = 5FFF_{\text{hex}} - 1 = 5FFE_{\text{hex}}$

CANopen parameter channels

The communication module has two parameter data channels which are both activated in the Lenze setting.



Note!

In order to establish the compatibility with CANopen, the second parameter data channel must be switched off via code C1200, see (📖 52).

7.2 Data transfer via the diagnostic interface

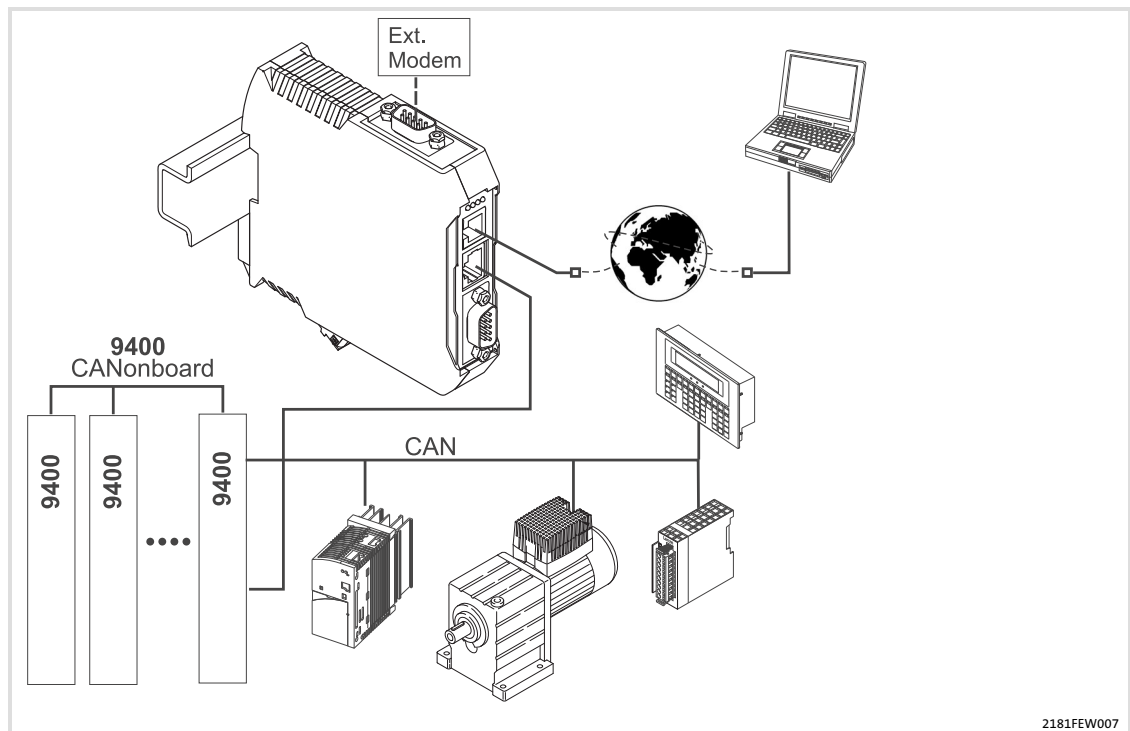

The inverters of the 9400 series are provided with a diagnostic interface. This is a point-to-point connection that supports hot plugging. It allows for the exchange of parameter data, IEC61131 programs, and other application data.

The inverters of the 9400 series are provided with a routing function, so that lower-level devices which are connected to each other via another bus can also be accessed via the diagnostic interface.

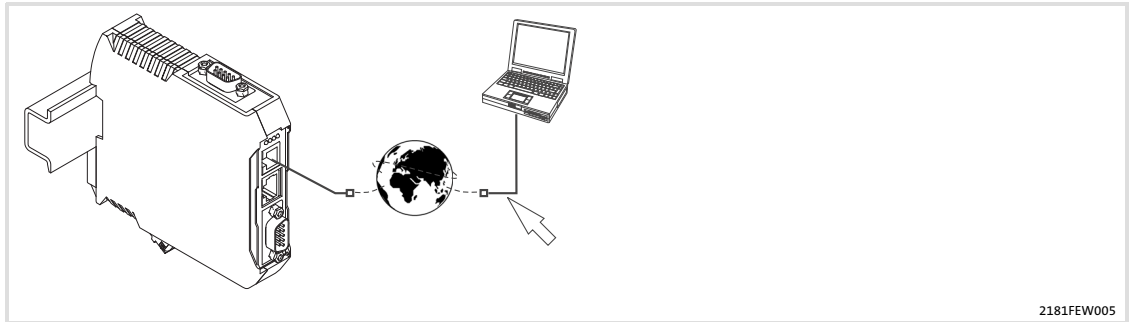
7.3**Data transfer via modem**

Data transfer by modem is performed using the PPP protocol that provides secure data transmission.

The system bus configurator serves to automatically establish the automatic dial-up connection on the PC side (see arrow).

The baud rate on the telephone line is adjusted by both modems. Depending on the quality of the connection, it is reduced automatically, if required, based on 33.6 kbits/s.

8 Lenze codes and CANopen objects

The behaviour of the communication module is defined by setting parameters for (Lenze) codes. These codes are exchanged as part of a message via the CAN bus.

In the following table you will find an overview of codes relevant for the communication module and the CAN objects implemented. Please note the references to additional information.



Note!

Convention for differentiating between the implemented CANopen indices and Lenze codes:

- ▶ CANopen index: I- + (index)
- ▶ Lenze code: C + (code number)

How to read the code table

Sample of a code table

Code	Name			Index:
Subcode	Lenze	Values	Access	Data type

RSP PS transfer CANopen:

Meaning

Headers	Meaning																
Code	Number of the parameter Cxxxx. Name: (Lenze) "code"																
Name	Name of the parameter (display text in the »Engineer« and in the keypad)																
Index	Information on addressing the code in hexadecimal and decimal notation (decimal value in brackets)																
Leading columns	Meaning																
Subcode	Number of the subcode																
Lenze	Lenze setting ("default setting) of the code																
	<table border="1"> <tr> <td><input type="checkbox"/> Disp</td> <td>Display code</td> </tr> <tr> <td></td> <td>The configuration of the code is not possible.</td> </tr> </table>	<input type="checkbox"/> Disp	Display code		The configuration of the code is not possible.												
<input type="checkbox"/> Disp	Display code																
	The configuration of the code is not possible.																
Values	<table border="1"> <tr> <td>minimum value</td> <td>[smallest increment/unit]</td> <td>maximum value</td> </tr> </table> For a display code, the displayed values are given.	minimum value	[smallest increment/unit]	maximum value													
minimum value	[smallest increment/unit]	maximum value															
Access	ro: The parameter can only be read (display code). rw: The parameter can be written.																
Data type	<table border="1"> <tr> <td>• FIX32</td> <td>32 bit value with sign; decimal with 4 decimal positions</td> </tr> <tr> <td>• S8</td> <td>8 bit value with sign</td> </tr> <tr> <td>• S16</td> <td>16 bit value with sign</td> </tr> <tr> <td>• S32</td> <td>32 bit value with sign</td> </tr> <tr> <td>• U8</td> <td>8 bit value without sign</td> </tr> <tr> <td>• U16</td> <td>16 bit value without sign</td> </tr> <tr> <td>• U32</td> <td>32 bit value without sign</td> </tr> <tr> <td>• VS</td> <td>Visible string, string with given length</td> </tr> </table>	• FIX32	32 bit value with sign; decimal with 4 decimal positions	• S8	8 bit value with sign	• S16	16 bit value with sign	• S32	32 bit value with sign	• U8	8 bit value without sign	• U16	16 bit value without sign	• U32	32 bit value without sign	• VS	Visible string, string with given length
• FIX32	32 bit value with sign; decimal with 4 decimal positions																
• S8	8 bit value with sign																
• S16	16 bit value with sign																
• S32	32 bit value with sign																
• U8	8 bit value without sign																
• U16	16 bit value without sign																
• U32	32 bit value without sign																
• VS	Visible string, string with given length																
Footer	Meaning																
RSP	The parameter can only be changed when the controller is inhibited (CINH) (<input checked="" type="checkbox"/>) / not possible (<input type="checkbox"/>)																
PS transfer	When the "Download parameter set" command is executed, the parameter is transferred to the inverter (<input checked="" type="checkbox"/>) / not transferred (<input type="checkbox"/>)																
CANopen	The reference to the corresponding CANopen object (according to CANopen specification DS301V402) is given (<input checked="" type="checkbox"/>) / not given (<input type="checkbox"/>)																

8.1 Overview

Code	Subcode	Index [hex]	Name	See
C0002	-	0x5FFD	Load parameter set	58
C0099	-	0x5F9C	Display of the software version	58
C0150	-	0x5F69	Status word	58
C0200	-	0x5F37	Software manufacturer's product code	59
C0350		0x5EA1	CAN node address	48
C0351	-	0x5EA0	CAN baud rate	49
C0358	-	0x5E99	Reset node	50
C0359		0x5E98	CAN status	50
C0360	1 2	0x5E97	CAN telegram counter	51
C0361	1 2	0x5E96	CAN bus load	52
C1200		0x5B4F	Parameter data channel operating mode	52
C1201		0x5B4E	Communication time-out (CAN)	53
C1202		0x5B4D	Time limit for node search	53
C1203		0x5B4C	Repeat tests	53
C1204		0x5B4B	Password protection	60
C1205		0x5B4A	Callback phone number	61
C1206		0x5B49	Modem initialisation command	62
C1207		0x5B48	Switch-over of internal / external modem	62
C1208		0x5B47	Country code	63
C1209		0x5B46	Detection of the baud rate	54
C1213		0x5B42	Connection via CAN or diagnostic interface	59
C1215		0x5B40	Time exceeded during automatic baud rate detection	54
C1219		0x5B3C	Activation of CAN device monitoring	54
C1223		0x5B38	User name	63
C1225		0x5B36	Baud rate of the external modem	64
C1226		0x5B35	Modem reset	64
C1227		0x5B34	Delay time for search telegrams	55

CANopen objects implemented

Index [hex]	Subindex	Name	See
I-1000	0	Device type	56
I-1001	0	Error register	56
I-1017	-	Producer heartbeat time	56
I-1018	0 ... 4	Identity object	57

8.2 Description of the codes relevant for CAN

C0350:
CAN node address

Code	Name		Index: 0x5EA1 (24225)
C0350	CAN node address		
Subcode	Lenze	Values	Access Data type
-	0	1 [1] 63 (127)	rw I32
<input type="checkbox"/> RSP <input checked="" type="checkbox"/> PS transfer		<input type="checkbox"/> CANopen:	

The node address can be set via the CAN bus using the code C0350.

If zero is used as the address, the communication module does not have a dedicated node address. It can then not be addressed from the CAN bus (no parameter setting, node guarding etc.), but only serves as a dialling-in feature for reading parameters via the CAN bus.

If the communication module should have an address, check, after the baud rate has been detected, whether this address is still free. Then, the implemented CANopen object 1000 is tried to be read. If another node already has this address, another free address is selected automatically.

**Note!**

Node addresses in the range of 64 ... 127 can only be assigned if the code C1200 is set to the value "0" (CANopen conformity).

Changes to the setting are applied after

- ▶ Reconnection to the mains
- ▶ "Reset node" or "Reset communication" via the bus system
- ▶ "Reset node" using the code C0358

C0351: Set baud rate

Code	Name		Index: 0x5EA0 (24224)	
C0351	CAN baud rate			
Subcode	Lenze	Values	Access	Data type
-	0	0 500 kbit/s 1 250 kbit/s 2 125 kbit/s 3 50 kbit/s 4 1000 kbps 5 20000 kbps 16 Automatic detection	rw	I32

RSP PS transfer CANopen:

The baud rate over the CAN bus can be set using this code.

Changes to the setting are applied after:

- ▶ Reconnection to the mains
- ▶ A "reset node" command via the bus system
- ▶ A reset node using the code C0358

Prior to accessing the CAN bus, the baud rate used is determined by the communication module and compared with the baud rate configured.

If the two values are different, the baud rate determined is used. The baud rate detected by the communication module can be read using code C1209.

If there is no data traffic on the CAN bus, the baud rate cannot be determined. The subsequent behaviour of the communication module depends on the selection configured in code C0351:

- ▶ **Selection 0 ... 5**
After a time-out that can be configured using code C1215, the CAN bus is accessed with the baud rate configured.
- ▶ **Selection 16 (automatic detection of the baud rate)**
The communication module does not access the bus until a baud rate can be detected.

C0358: Reset node

Code	Name		Index: 0x5E99 (24217)	
C0358	Reset node			
Subcode	Lenze	Values	Access	Data type
-	0	0: No function 1: CAN reset	rw	I32
<input type="checkbox"/> RSP <input checked="" type="checkbox"/> PS transfer		<input type="checkbox"/> CANopen:		

After a reset any changes to communication parameters such as baud rate or node address are applied.

Entries with new baud rates or changes to the node address only become valid after a node reset.

A node reset can be performed by:

- ▶ Reconnection to the mains
- ▶ Reset node via the bus system
- ▶ Reset node using code C0358

C0359: Diagnostics of the bus status

Code	Name		Index: 0x5E98 (24216)	
C0359	Diagnostics of the bus status			
Subcode	Lenze	Values	Access	Data type
-	<input type="text" value="Disp"/>	0: Operational 1: Pre-Operational 2: Warning 3: Bus-Off 4: Stopped	ro	I32
<input type="checkbox"/> RSP <input checked="" type="checkbox"/> PS transfer		<input type="checkbox"/> CANopen:		

This code displays the current operating status of the CAN controller. Here a differentiation is made between 4 states:

- ▶ Selection 0: Operational

In this state the bus system is fully functional.

- ▶ Selection 1: Pre-Operational

In this state only parameters (codes) can be transferred via the bus system. It is not possible to exchange process data. To change to the "Operational" state a network management message must be output on the bus.

A state change from "Pre-operational" to "Operational" can be made with the following actions:

- A drive is defined as the master using code C0352. When connecting to the mains an automatic state change for the entire drive system is performed after the defined boot-up time C0356/1.
- Using code C0358 reset node (prerequisite: C0352 = 1).
- Using the binary reset node input signal that can be set, e. g. using the code C0364 via a terminal given an appropriate configuration (prerequisite: C0352 = 1).
- A network management message from a CAN master.

► Selection 2: Warning

Error messages have been received if the state is "Warning". The CAN node is now only passive; no more data are sent from the inverter.

The reason for this situation can be:

- A missing bus terminator
- Inadequate shielding
- Potential differences at the ground connection for the control electronics
- An excessively high bus load
- CAN node is not connected to the bus

► Selection 3: Bus Off

The frequency of the erroneous messages has resulted in the CAN node decoupling itself from the bus. It is possible to switch to the "Pre-Operational" state with:

- A trip reset
- A reset node
- Reconnection to the mains

► Selection 4: Stopped

Only NMT telegrams can be received.

The state can be changed to "Pre-Operational" by:

- Reconnection to the mains
- Reset node via the bus system
- Reset node via the code C0358

C0360: Diagnostics of the telegram counter

Code C0360	Name Diagnostics of the telegram counter			Index: 0x5E97 (24215)	
Subcode	Lenze	Values	Access	Data type	
1, 2 (see table below)	<input type="checkbox"/> Disp	0 [1] 4294967295	ro	I32	
<input type="checkbox"/> RSP <input checked="" type="checkbox"/> PS transfer			<input type="checkbox"/> CANopen:		

Subcode	Meaning	Messages
1	Message OUT	<ul style="list-style-type: none"> ● Message counter (number of messages) ● Counter value > 4294967295: Start again at 0
2	Message IN	all received

All CAN telegrams transmitted and received of this node are counted.

The counters have 32 bits, i. e. when a value of 4294967295 is exceeded, the counting process starts again at 0.

C0361: Diagnostics of the bus load

Code C0361	Name Diagnostics of the bus load			Index: 0x5E96 (24214)	
Subcode	Lenze	Values	Access	Data type	
-	<input type="checkbox"/> Disp	0 [1 %] 100	ro	I32	
<input type="checkbox"/> RSP <input checked="" type="checkbox"/> PS transfer			<input type="checkbox"/> CANopen:		

Using this code the percentage total bus load can be determined. Erroneous messages are not taken into account here.



Note!

- ▶ The bus load for all devices involved should not exceed 80 %.
- ▶ If other devices, e. g. decentralised inputs and outputs are connected, these messages are also to be taken into account.

C1200: Parameter data channel operating mode

Code C1200	Name Operating mode - parameter data channel			Index: 0x5B4F (23375)	
Subcode	Lenze	Values	Access	Data type	
-	2	0 [1] 2	rw	I32	
<input type="checkbox"/> RSP <input checked="" type="checkbox"/> PS transfer			<input type="checkbox"/> CANopen:		

This code indicates which of the two parameter data channels is used to communicate with other nodes. The unused parameter data channels can be switched off, if required.

All Lenze inverters have two parameter data channels with different addressing. The address of the parameter channel 2 is calculated as follows:

Address of parameter data channel 2 =

Address of parameter data channel 1 + offset 64

Selection	Accessible address range	Active parameter data channels
0	1...127	SDO 1
1	1 ... 63	SDO1 / SDO2
2	65 ... 127	SDO1 / SDO2



Note!

The selection 0 means that the bus is operating in compliance with CANopen and there is no limitation on the address space.
In this case, the parameter data channel SDO2 is inactive.

C1201: Communication timeout (CAN)

Code C1201	Name Communication time-out (CAN)				Index: 0x5B4E (23374)	
Subcode	Lenze	Values	Access	Data type		
	1500	0 [1 ms] 10000	rw	I32		
<input type="checkbox"/> RSP <input checked="" type="checkbox"/> PS transfer			<input type="checkbox"/> CANopen:			

The time set defines the time frame within which a CAN node must respond to a request. If there is no response of the node, the requesting module assumes that the node is not available.

C1202: Time limit for node search

Code C1202	Name Time limit for node search				Index: 0x5B4D (23373)	
Subcode	Lenze	Values	Access	Data type		
	1000	0 [1 ms] 10000	rw	I32		
<input type="checkbox"/> RSP <input checked="" type="checkbox"/> PS transfer			<input type="checkbox"/> CANopen:			

For node search, the time set is regularly maintained. It must be selected high enough to enable the nodes to have enough time to respond. Otherwise, a too high value delays the search.



Note!

If required, the settings in C1202 must be adapted if the delay time for search telegrams increased with code C1227.

C1203: Repeat tests

Code C1203	Name Repeat tests				Index: 0x5B4C (23372)	
Subcode	Lenze	Values	Access	Data type		
	0	0 [1] 10	rw	I32		
<input type="checkbox"/> RSP <input checked="" type="checkbox"/> PS transfer			<input type="checkbox"/> CANopen:			

The value to be set in code C1203 indicates the number of repetitions of the CAN telegrams which have not reached the receiver.

The precondition for this functionality is the activation of the CAN device monitoring function with code C1219 (54).

This function extension is available from version 1.70 onwards!

The Lenze setting of the repeat tests was changed from 1 to 0 in order to obtain a corresponding return value from the communication module if a bus node is not available ("DEVICE_NOT_PRESENT").

C1209:**Read out baud rate**

Code	Name				Index: 0x5B46 (23366)
C1209	Read out baud rate				
Subcode	Lenze	Values		Access	Data type
	<input type="checkbox"/> Disp	0	500 kbit/s	ro	I32
		1	250 kbit/s		
		2	125 kbit/s		
		3	50 kbit/s		
		4	1000 kbps		
		16	nothing detected		
<input type="checkbox"/> RSP <input checked="" type="checkbox"/> PS transfer			<input type="checkbox"/> CANopen:		

Code C1209 can be used to determine which transfer rate was detected on the CAN bus.

When "16" is indicated, there is no data traffic on the CAN bus.

C1215:**Time-out (automatic baud rate detection)**

Code	Name				Index: 0x5B40 (23360)
C1215	Time-out				
Subcode	Lenze	Values		Access	Data type
	1000	0	[1] 60000	rw	I32
<input type="checkbox"/> RSP <input checked="" type="checkbox"/> PS transfer			<input type="checkbox"/> CANopen:		

By defining a time-out in code C1215, the baud rate (display with code C1209) on the CAN bus can be detected.

The baud rate is not checked if the value configured in code C1215 is set to zero.

When the time-out configured in code C1215 elapses, the CAN bus is accessed (for further information and limitations: see description of code C0351).

C1219: Activation of CAN device monitoring

Code	Name				Index: 0x5B3C (23356)
C1219	Activation of CAN device monitoring				
Subcode	Lenze	Values		Access	Data type
	1	0: not activated	1: activated	rw	U32
<input type="checkbox"/> RSP <input checked="" type="checkbox"/> PS transfer			<input type="checkbox"/> CANopen:		

This code serves to activate the device monitoring.

The activated device monitoring enables the detection of bus nodes with disturbed bus communication.

**Tip!**

This code can also be configured via the gateway configuration website of the 2180 communication module (EthernetCAN).

C1227:
Delay time for search telegrams

Code	Name				Index: 0x5B34 (23348)	
C1227	Delay time for search telegrams					
Subcode	Lenze	Values		Access	Data type	
	0	0	[1 ms]	100	rw	I32
<input type="checkbox"/> RSP <input checked="" type="checkbox"/> PS transfer				<input type="checkbox"/> CANopen:		

Selection	Meaning
0	Quickest possible search
1 ... 10	Delay time 1 ms
11 ... 19	Delay time 10 ms
20 ... 29	Delay time 20 ms
...	...
...	...
90...100	Delay time 90 ms

Searching the CAN bus during the start of a PC program can lead to faults if a bus is heavily loaded. In order to prevent this, a delay time between the transmission telegrams can be set. This, however, leads to an increase of the total search time. If required, C1202 must be adapted accordingly.

8.3 Description of the CANopen objects implemented

I-1000_{hex}:
Device type

Index [_{hex}]	Subindex	Name	Data type	Value range	Authorisation
I-1000	0	Device type	U32	0 ... 2 ³² - 1	ro

The object I-1000 specifies the device profile for this device. It is also possible to include additional information here that is defined in the device profile itself. If no specific device profile is used, the content is "0x0000".

Data telegram assignment

Byte 8	Byte 7	Byte 6	Byte 5
U32			
Device profile number		Additional information	

I-1001_{hex}:
Error register

Reading the error register

Index [_{hex}]	Subindex	Name	Data type	Value range	Rights
I-1001	0	Error register	U8	0...255	ro

Error status for the following bit assignment in the data byte (U8):

Bit 7	Bit 6	Bit 5	Bit 4	Bit 3	Bit 2	Bit 1	Bit 0	Error status
0	0	0	0	0	0	0	0	No error
0	0	0	0	0	0	0	1	Error in the communication module
0	0	0	1	0	0	0	1	Communication error

I-1017_{hex}:
Producer heartbeat time

Index [_{hex}]	Subindex	Name	Data type	Value range	Rights
I-1017	-	Producer heartbeat time	U32	U 16	rw

The heartbeat message is sent cyclically by the heartbeat generator (producer) to one or more recipients (consumers).

After configuring the heartbeat producer time, the heartbeat protocol starts at the transition from the NMT state INITIALISATION to the NMT state PREOPERATIONAL (if predefined value > 0).

**Note!**

Unlike "node / life guarding" monitoring, the heartbeat protocol does not contain a "Remote Transmit Request" (RTR).

It is therefore not necessary for the recipient to answer after a heartbeat.

I-1018_{hex}:
Module device description

Entry of vendor ID

Index [_{hex}]	Subindex	Name	Data type	Value range	Authorisation
I-1018	0 ... 4	Module device description	Identity	Module-specific	ro

Subindices

Subindex	Meaning
0	Highest subindex
1	Vendor ID = ID assigned to Lenze by the organisation "CIA"
2	Product code
3	Revision number
4	Serial number

8.4 Description of the general codes

**C0002 (extract):
Device commands**

Code C0002	Name Device commands			Index: 0x5FFD (24573)	
Subcode	Lenze	Values	Access	Data type	
-	0	0, 1	rw	I32	
<input type="checkbox"/> RSP <input checked="" type="checkbox"/> PS transfer <input type="checkbox"/> PLC-STOP			<input type="checkbox"/> CANopen:		

C0002 shows the status of the device command executed last. C00150 can be used to enquire the current status of the device control.

Values (extract)	Designation	Info
0	Load Def.	Load Lenze setting <ul style="list-style-type: none"> Only possible with controller inhibit and stopped user program.
1	Load PS	Load parameter set The parameter set stored in the memory module is loaded <ul style="list-style-type: none"> Only possible with controller inhibit and stopped user program.

**C0099:
Software version**

Code C0099	Name Software version			Index: 0x5F9C (24476)	
Subcode	Lenze	Values	Access	Data type	
	<input type="text" value="Disp"/>	x.y (x: major version, y: index)	ro	FIX32	
<input type="checkbox"/> RSP <input checked="" type="checkbox"/> PS transfer			<input type="checkbox"/> CANopen:		

**C0150:
Status word**

Code C0150	Name CAN node address			Index: 0x5F69 (24425)	
Subcode	Lenze	Values	Access	Data type	
	<input type="text" value="Disp"/>		ro	B16	
<input type="checkbox"/> RSP <input checked="" type="checkbox"/> PS transfer			<input type="checkbox"/> CANopen:		

The binary interpretation of the displayed decimal value reflects the bit statuses of the status word:

- ▶ Bit 0: Ready for operation
- ▶ Bit 1: Dial-up connection is available
- ▶ Bit 2: Internal error

**C0200:
Software ID**

Code C0200	Name Software manufacturer's product code			Index: 0x5F37 (24375)
Subcode	Lenze	Values	Access	Data type
	Disp		ro	VS
<input type="checkbox"/> RSP <input checked="" type="checkbox"/> PS transfer		<input type="checkbox"/> CANopen:		

During initialisation of the module it is determined which device is connected as a user based on the manufacturer's product code.

Value displayed for the 2181 communication module:

"33S2181F_10000".

**C1213:
Fieldbus connection**

Code C1213	Name Fieldbus connection			Index: 0x5B42 (23362)
Subcode	Lenze	Values	Access	Data type
	0	0, 1	rw	FIX32
<input type="checkbox"/> RSP <input checked="" type="checkbox"/> PS transfer		<input type="checkbox"/> CANopen:		

In code C1213, the fieldbus connection has to be entered:

C1213 = 0: connection of modemCAN 2181 and the inverter via the CAN bus.

C1213 = 1: connection of modemCAN 2181 with the diagnostic interface of the inverter 9400.



Note!

It is not possible to operate both connections of the communication module in parallel.

8.5

Description of the codes relevant for the modem

**C1204:
Password**

Code C1204	Name Password		Index: 0x5B4B (23371)	
Subcode	Lenze	Values	Access	Data type
	-	Empty: no password protection	w	VS
<input type="checkbox"/> RSP <input checked="" type="checkbox"/> PS transfer		<input type="checkbox"/> CANopen:		

Code C1204 provides the possibility of protecting the ModemCAN 2181 communication module against unauthorised access by allocation of a password.

During the dialup process, the password stored in the PC is compared with the password stored in the communication module:

- ▶ The dialup process is continued if both passwords are identical.
- ▶ The dialup process is aborted immediately or after a short waiting time if the passwords are not identical or the user names do not comply with each other (see code C1223).

**Note!**

- ▶ In code C1204 a new password, or - with an empty selection field - no password, can be entered via the CAN bus.
- ▶ The password is not reset when the Lenze setting is loaded.
- ▶ The new password is only accepted after mains switching.
- ▶ Observe upper and lower case letters.

C1205: Callback phone number

Code C1205	Name Callback phone number			Index: 0x5B4A (23370)	
Subcode	Lenze	Values	Access	Data type	
	-		rw	VS	
<input type="checkbox"/> RSP <input checked="" type="checkbox"/> PS transfer			<input type="checkbox"/> CANopen:		

With code C1205, a telephone connection (callback phone number) can be entered, which is called back immediately after the dial-up process.

If no phone number is entered in C1205, a callback is not executed; the connection is maintained and is directly used for remote maintenance.



Note!

Changes to this code only become effective if the mains is switched again, or by a modem reset (code C1226).

To enable your PC to take a callback from the communication module, it is required to mark the corresponding connection as "Callback" in the system bus configurator.



Tip!

More information about the callback function can be found in the online help of the system bus configurator.

C1206: Modem initialisation

Code C1206	Name Modem initialisation			Index: 0x5B49 (23369)	
Subcode	Lenze	Values	Access	Data type	
	AT&FE1Q0&K3&D2&C1		rw	VS	
<input type="checkbox"/> RSP <input checked="" type="checkbox"/> PS transfer			<input type="checkbox"/> CANopen:		



Note!

In most cases, the use of the Lenze setting is sufficient for initialising the modem.

However, if it is not possible to establish a connection, there is the possibility of adapting the initialisation command via the applicable AT commands.

Only change the value of this code if you are absolutely sure that it is necessary!

An incorrect initialisation command may make another dialup process impossible. In this case you have to load the Lenze setting of the modem and correct the AT commands entered before.

With code C1206, the internal or external modem receives an initialisation command that in most cases consists of several AT commands.



Note!

Changes to this code only become effective if the mains is switched again, or by a modem reset (code C1226).



Tip!

For the ModemCAN 2181 communication module, a part of the whole amount of commands is represented in the annex of these instructions.

C1207: Switch-over of internal / external modem

Code C1207	Name Switch-over of internal / external modem			Index: 0x5B48 (23368)	
Subcode	Lenze	Values	Access	Data type	
	0	0, 1	rw	FIX32	
<input type="checkbox"/> RSP <input checked="" type="checkbox"/> PS transfer			<input type="checkbox"/> CANopen:		

Using code C1207, a switch-over from the internal to the external modem can be effected. This code can only be written to via CAN.



Note!

Changes to this code only become effective if the mains is switched again, or by a modem reset (code C1226).

C1208: Country code

Code C1208	Name Country code			Index: 0x5B47 (23367)	
Subcode	Lenze	Values	Access	Data type	
	253	See  68	rw	FIX32	
<input type="checkbox"/> RSP <input checked="" type="checkbox"/> PS transfer			<input type="checkbox"/> CANopen:		

By means of code C1208, the code for the country in which the modem is used can be entered.

The internal modem is approved for many countries. However, since the properties required in the respective countries show slight differences, the modem must adapt to the situation in each case. For this, enter the corresponding country code which is the same in all European countries.



Note!

Changes to this code only become effective if the mains is switched again, or by a modem reset (code C1226).

C1223: user name

Code C1223	Name User name			Index: 0x5B38 (23352)	
Subcode	Lenze	Values	Access	Data type	
	Lenze		rw	VS	
<input type="checkbox"/> RSP <input checked="" type="checkbox"/> PS transfer			<input type="checkbox"/> CANopen:		

Code C1223 can be used to enter a user name. By the Lenze setting, the user name "Lenze" is pre-assigned to the code.



Note!

- ▶ The user name is not reset when the Lenze setting is loaded.
- ▶ Observe upper and lower case letters.

C1225: baud rate of the external modem

Code	Name			Index: 0x5B36 (23350)	
C1225	Baud rate of the external modem				
Subcode	Lenze	Values	Access	Data type	
	3	0 9600 bps 1 19200 bps 2 38400 bps 3 57600 bps	rw	FIX32	

RSP PS transfer CANopen:

Code C1225 is used for determining the baud rate via which the communication module communicates with external modems. Most modems are provided with a function for the automatic detection of the baud rate, so that it is not necessary to alter this parameter. Only in exceptional cases, the default baud rate of the external modem must be set here. If initialisation with the baud rate configured fails, an automatic attempt to use another baud rate is made.



Note!

Changes to this code only become effective if the mains is switched again, or by a modem reset (code C1226).

C1226: modem reset

Code	Name			Index: 0x5B35 (23349)	
C1226	Modem reset				
Subcode	Lenze	Values	Access	Data type	
	0	0, 1	rw	I32	

RSP PS transfer CANopen:

The change made to the modem parameters only becomes effective when the mains is switched for the next time, or by activation of code C1226.

9 Troubleshooting and fault elimination

Possible cause of error	Diagnostics	Remedy
The device is not switched on	Power LED does not illuminate	Check external voltage supply
CAN bus error	ERR LED is lit or blinking	Check CAN wiring

9.1 Signalling of the CANopen RUN LED and ERROR LED

9.1.1 CAN operating mode

CANopen ERROR LED

The CANopen ERROR LED displays the status of the physical CAN level and shows errors on the basis of missing CAN messages (SYNC, GUARD or HEARTBEAT). It is lit red.

No.	ERROR LED	STATUS	Description
1	OFF	No error	The device is ready for operation.
2	Single lighting up	Warning limit is reached	At least one of the error counters of the CAN controller has reached or exceeded the warning level (too many error frames).
3	Flicker	AutoBaud/LSS	The automatic baud rate detection or LSS services are running. (ERROR LED and RUN LED flicker alternately).
4	Double lighting up	Error control event	A guard event (NMT slave or NMT master) or heartbeat event (heartbeat consumer) has occurred.
5	Triple lighting up	Sync error	The sync message has not been received within the time configured for the time monitoring of the communication cycle..
6	On	Bus Off	The CAN controller is in the bus-off state.

CANopen RUN LED

The CANopen RUN LED displays the CANopen-NMT status. It is lit up green.

No.	CAN RUN LED	STATUS	Description
1	Flicker	AutoBaud/LSS	The automatic baud rate detection or LSS services are running. (ERROR LED and RUN LED flicker alternately). Optional
2	Single lighting up	STOPPED	The device in the STOPPED state.
3	Blinking	PRE-OPERATIONAL	The device is in the PREOPERATIONAL state.
4	On	OPERATIONAL	The device is in the OPERATIONAL state.

Message states and lighting rates

The following message states are distinguished:

Troubleshooting and fault elimination

Signalling of the CANopen RUN LED and ERROR LED

Operating mode - diagnostic interface

Signalling	Meaning
LED is lit	On
LED is not lit	OFF
LED flickers	Isophase on and off with approx. 10 Hz: on for approx. 50 ms and off for approx. 50 ms.
LED is blinking	Isophase on and off with approx. 2.5 Hz: on for approx. 200 ms, followed by off for approx. 200 ms.
Single lighting up of the LED	A short lighting up (approx. 200 ms) followed by a long off phase (approx. 1000 ms).
Double lighting up of the LED	LED shortly lights up twice in one sequence (approx. 200 ms), interrupted by an off phase (approx. 200 ms). The sequence is completed by a long off phase (approx. 1000 ms).
Triple lighting up of the LED	LED shortly lights up thrice in one sequence (approx. 200 ms), interrupted by an off phase (approx. 200 ms). The sequence is completed by a long off phase (approx. 1000 ms).

9.1.2

Operating mode - diagnostic interface



Note!

In this operating mode, the CANopen ERR LED is lit if no device is connected.

10 Appendix

10.1 Modem standards

Application range	Name
Data transfer	V.34
	V.32bis
	V.22bis
	V.22
	V.23
	V.21
	Bell212A
	Bell103
Error correction	V.42 (LAP-M or MNP 2-4)
Data compression	V.42bis
	MNP5

10.2 List of countries

The national telephone standards differ somewhat. For this reason the communication assembly needs to be configured for use in certain countries.

The modem used supports the following standards:

- ▶ **CTR21** (Common Technical Regulation):
This approval applies for all EU countries including Norway and Switzerland. It is based on the TBR21 standard prepared by the ETSI (European Telecommunications Standard Institute).
- ▶ **FCC Part 68** (Federal Communications Commission):
This approval applies for the USA.

Some countries require special adaptations which must be entered into the decimal code with code C1208 for this device (see table below).

The following lists provides information on the countries in which the device can be used in relation to telecommunication standards.



Note!

If the respective country is not in the list, only an external modem that complies with the related national regulations is allowed to be used.

Country	Code		Approval
	hex	dec	
Argentina	07	7	available
Australia	09	9	available
Austria	FD	253	CTR21
Belgium	FD	253	CTR21
Brazil	16	22	available
Canada	B5	181	available
Chile	99	153	available
China	B5	181	available
Cyprus	FD	253	CTR21
Czech Republic	FD	253	CTR21
Denmark	FD	253	CTR21
Estonia	FD	253	CTR21
Finland	FD	253	CTR21
France	FD	253	CTR21
Germany	FD	253	CTR21
Great Britain	FD	253	available
Greece	FD	253	CTR21
Greenland	FD	253	CTR21
Hong Kong	99	153	available
Hungary	FD	253	CTR21
India	99	153	available
Indonesia	99	153	available
Ireland	FD	253	CTR21
Israel	B5	181	CTR21

Country	Code		Approval
	hex	dec	
Italy	FD	253	CTR21
Japan	00	0	available
Korea	B5	181	available
Liechtenstein	FD	253	CTR21
Luxembourg	FD	253	CTR21
Malaysia	6C	108	
Mexico	B5	181	available
Netherlands	FD	253	CTR21
New Zealand	7E	126	available
Norway	FD	253	CTR21
Philippines	B5	181	available
Poland	99	153	available
Portugal	FD	253	CTR21
Russia	B5	181	available
Singapore	96	156	available
Slovakia	FD	253	CTR21, in preparation
Slovenia	FD	253	available
South Africa	9F	159	
Spain	FD	253	CTR21
Sweden	FD	253	CTR21
Switzerland	FD	253	CTR21
Taiwan	FE	254	available
Turkey	FD	253	available
USA	B5	181	available

10.3 AT commands

10.3.1 General modem control commands

Command: \N**Operating mode - error correction**

Checks the preferred error correction operating mode which is set automatically when a subsequent data connection is established. This command is defined by the third party manufacturer's firmware configuration.

Command	Default setting	Values defined	Result codes	
\N	5	\N0	Selects the buffered operating mode at normal speed (deactivates the error correction operating mode). (Forces &Q6).	OK otherwise ERROR
		\N1	Serial interface selected: Selects the direct operating mode and equals &M0, Q0 operating mode. (Forces &Q0). Parallel interface selected: the same as \N0.	
		\N2	Selects the reliable (error correction) operating mode. The modem attempts to establish a LAPM connection first, then an MNP connection. If no reliable connection is established, the modem hangs up. (Forces &Q5, S36=4 and S48=7).	
		\N3	Selects the auto-reliable operating mode which works in the same way as \N2, except for the fact that the inability to establish a reliable connection causes the modem to go back to the buffered operating mode at normal speed. (Forces &Q5, S36=7 and S48=7).	
		\N4	Selects the LAPM error correction operating mode. If it is not possible to establish a LAPM error correction connection, the modem hangs up. (Forces &Q5 and S48=0). Note: The -K1 command can overwrite an \N4 command.	
		\N5	Selects the MNP error correction operating mode. If it is not possible to establish an MNP error correction connection, the modem hangs up. (Forces &Q5, S36=4 and S48=128).	

Command: &F**Restores the configuration provided by the factory (profile)**

The modem loads the preset configuration provided by the factory (profile). The default settings made by the factory are marked for each command and in the S-parameter descriptions. A configuration (profile) consists of a subset of S-parameters.

Command	Default setting	Values defined	Result codes	
-	-	&F0	Restoring configuration 0 provided by the factory.	OK ERROR if the modem has established a connection.
		&F	Restoring configuration 1 provided by the factory.	

Command: &Y**Creation of a default reset profile**

Selects the user profile that is used after a hard reset.

Command	Default setting	Values defined		Result codes
&Y	-	&Y0	The modem uses profile 0.	OK ERROR if <value> is > 1 or if NVRAM is not installed or is not ready for operation.
		&Y1	The modem uses profile 1.	

Command: &W**Save current configuration**

Saves the current (active) configuration (profile), including the S-parameters, to one of the two user profiles in NVRAM, as defined by the parameter value. This command triggers an error message if it is determined by the NVRAM test that NVRAM is not installed or is not ready for operation. The current configuration consists of a list of storable parameters which is represented in the &V-command. These settings are reset to the active configuration if a Z-command is received, or at the start. (See &Y-command).

Command	Default setting	Values defined		Result codes
&W	0	&W0	Save the current configuration as profile 0.	OK otherwise ERROR
		&W1	Save the current configuration as profile 1.	

10.3.2 Interface commands for the DEE modem

Command: X**Extended result codes**

Selects the subset of the result code messages used by the modem to inform the DEE about the results of the commands. Blind dialling is activated or deactivated by the country parameters. If the user wants to force a dial tone detection, a "W" can be inserted in the character string to be selected. (See D-command, not described in this manual). The information below is based on the standard version of the X result table. If the modem is in the "Facsimile" operating mode (+FCLASS=1, 1,0, or 2), CONNECTED without a speed display is the only message being transmitted to indicate a connection.

Command	Default setting	Values defined	Result codes	
X	4	X0	Deactivates the signalling of busy signals if this is not forced in the country requirements; only sends OK, CONNECT, RING, NO CARRIER, ERROR, and NO ANSWER result codes. Blind dialling is activated/deactivated by the country parameters. If the function for busy signal detection is activated and a busy signal is detected, NO CARRIER is signalled. If the function for dial tone detection is activated or selected and no dial tone is detected, NO CARRIER instead of NO DIAL TONE is signalled. The value 000b is rewritten to S22 bits 6, 5, and 4, respectively.	OK otherwise ERROR
		X1	Deactivates the signalling of busy signals if this is not forced in the country requirements; only sends OK, CONNECT, RING, NO CARRIER, ERROR, NO ANSWER, and CONNECT XXXX (XXXX = rate). Blind dialling is activated/deactivated by the country parameters. If the function for busy signal detection is activated and a busy signal is detected, NO CARRIER instead of BUSY is signalled. If the function for dial tone detection is activated or selected and no dial tone is detected, NO CARRIER instead of NO DIAL TONE is signalled. The value 100b is rewritten to S22 bits 6, 5, and 4, respectively.	
		X3	Activates the signalling of busy signals; only sends OK, CONNECT, RING, NO CARRIER, ERROR, NO ANSWER, and CONNECT XXXX. Blind dialling is activated/deactivated by the country parameters. If the function for dial tone detection is activated and no dial tone is detected, NO CARRIER is signalled. The value 110b is rewritten to S22 bits 6, 5, and 4, respectively.	
		X4	Activates the signalling of busy signals; send all messages. The value 111b is rewritten to S22 bits 6, 5, and 4, respectively.	

10.3.3 Call control commands

Command: T

Preset dual tone multiplexed frequency dialling

Forces DTMF dialling mode until the next P-dial modifier or P-command is received. The modem sets an S-parameter bit to indicate that each subsequent dialling process is to take place in dual tone multiplexed frequency dialling. The DP-command (not described in this manual) overwrites this command. Deletes S14 bit 5. This command may not be permitted in some countries. (See P-command).

Command	Default setting	Values defined	Result codes
T			OK

Command: P

Preset pulse dialling mode

Forces pulse dialling mode until the next T-dial modifier or T-command is received. Sets S14 bit 5. When a dialling command is executed, expressly specifying a dialling process for this specific call (e.g. ATDT), this command is overwritten, so that each future dialling process is executed in dual tone multiplexed frequency dialling. (See T-command). This command may not be permitted in some countries.

Command	Default setting	Values defined	Result codes
P			OK

Command: &G

Select guard tone

Induces the modem to generate the guard tone selected by this command (only for modems with phase-shift-keyed modulation, DPSK). If it is valid, the parameter value is rewritten to S23 bits 6 and 7. This command may not be permitted in some countries.

Command	Default setting	Values defined	Result codes	
&G	0	&G0	Deactivates guard tone (default setting).	<value> = 0 to 2 otherwise ERROR
		&G1	Deactivates guard tone.	
		&G2	Selects 1800 Hz guard tone.	

Command: &P**Select pulse dialling mode****make/break ratio**

Determines the make/break ratio which is used in pulse dialling mode. The default setting depends on the country. If it is valid, the parameter value is rewritten to S28 bits 3 and 4.

Command	Default setting	Values defined		Result codes
&P	0	&P0	Selects a 39%-61% make/break ratio at 10 pulses per second.	OK otherwise ERROR
		&P1	Selects a 33%-67% make/break ratio at 10 pulses per second.	
		&P2	Selects a 39%-61% make/break ratio at 20 pulses per second.	
		&P3	Selects a 33%-67% make/break ratio at 20 pulses per second.	

10.3.4 Modulation control commands

Command: +MS

Modulation range

This composite parameter for an extended format checks the mode of operation of the modulation capabilities in the modem. It accepts 6 subparameters. Syntax: +MS=[<carrier>[,<automode>[,<min_tx_rate>[,<max_tx_rate> [,<min_rx_rate> [,<max_rx_rate>]]]]]]] Where possible, the following table lists <carrier>, <min_tx_rate>, <max_tx_rate>, <min_rx_rate> and <max_rx_rate> -values:

Modulation	<carrier>	Possible (<min_rx_rate>, <min_rx_rate>, (<min_tx_rate>), and <max_tx_rate>) rates (bps)
Bell 103	B103	300
Bell 212	B212	1200 Rx/75 Tx or 75 Rx/1200 Tx
V.21	V21	300
V.22	V22	1200
V.22bis	V22B	2400 or 1200
V.23	V23C	1200
V.32	V32	9600 or 4800
V.32bis	V32B	14400, 12000, 9600, 7200, or 4800
V.34	V34	33600, 31200, 28800, 26400, 24000, 21600, 19200, 16800, 14400, 12000, 9600, 7200, 4800, or 2400
56K	K56	56000, 54000, 52000, 50000, 48000, 46000, 44000, 42000, 40000, 38000, 36000, 34000, 32000
V.90	V90	56000, 54667, 53333, 52000, 50667, 49333, 48000, 46667, 45333, 44000, 42667, 41333, 40000, 38667, 37333, 36000, 34667, 33333, 32000, 30667, 29333, 28000
V.92 downstream	V92	56000, 54667, 53333, 52000, 50667, 49333, 48000, 46667, 45333, 44000, 42667, 41333, 40000, 38667, 37333, 36000, 34667, 33333, 32000, 30667, 29333, 28000
V.92 upstream	V92	48000, 46667, 45333, 44000, 42667, 41333, 40000, 38667, 37333, 36000, 34667, 33333, 32000, 30667, 29333, 28000, 26667, 25333, 24000

Note: It may be the case that some <carrier> values of certain modem models are not supported. It may for instance happen that V92 modem models do not support K56 modem models.

Tab. 10-1 +MS command supports rates

Command	Default setting	Values defined	Result codes
+MS		<p><carrier> A string that specifies the modem carrier preferred, which is used when a connection is created or answered. <carrier> values are strings of up to eight characters, which only consist of digits and upper case letters. <carrier> values for ITU standard modulations have the following form: <letter><1-4 digits><other letters, as required>. Values defined are listed in Tab. 10-1.</p> <p><automode> A numerical value which activates or deactivates the automatic modulation setting (ITU-T V.32bis annex A or V.8). 0 = auto-mode activated. 1 = auto-mode deactivated (default setting).</p> <p><min_rx_rate> and <max_rx_rate> Numerical values that specify the lowest (<min_rx_rate>) and highest (<max_rx_rate>) rate at which the modem can establish a receive connection. They can also be used to determine other limit values for the reception and distinguish them from the transmission. Values for this subparameter are decimally coded in bps units. The possible values for each modulation are listed in Tab. 10-1. According to the <carrier> values and the replacement <carrier> values entered, as they are determined during operation, current values are limited to possible values. (Default setting = lowest (<min_rx_rate>) and highest (<max_rx_rate>) rate supported by the carrier selected).</p> <p><min_tx_rate> and <max_tx_rate> Numerical values that specify the lowest (<min_tx_rate>) and highest (<max_tx_rate>) rate at which the modem can establish a transmission connection. Non-zero values for this subparameter are decimally coded in bps units. The possible values for each modulation are listed in Tab. 10-1. Current values are limited to possible values according to the <carrier> and replacement <carrier> values entered, as they are determined during operation. (Default setting = lowest (<min_tx_rate>) and highest (<max_tx_rate>) rate supported by the carrier selected).</p>	OK - valid string for subparameters otherwise ERROR

Commands reported

+MS?	<p>Reports current rates</p> <p>Response: +MS:<carrier>,<automode>,<min_tx_rate>, <max_tx_rate>, <min_rx_rate>,<max_rx_rate> Note: The current active settings are reported under control of the +MR parameters. Example: +MS: K56, 1,300,33600,300,56000 for default values. This example allows for maximum system flexibility for defining optimum reception and transmission rates during operation.</p>
+MS=?	<p>Reports the parameter value range supported</p> <p>Response: +MS: (< carrier> range),(<automode> range),(<min_tx_rate> range),(<max_tx_rate> range),(<min_rx_rate> range),(<max_rx_rate> range) Example 1: +MS:(B103,B212,V21,V22,V22B,V23C,V32,V32B,V34, K56,V90),(0,1),(300-33600),(300-33600),(300-56000),(300- 56000) Example 2: +MS:(B103,B212,V21,V22,V22B,V23C,V32,V32B,V34, V90,V92),(0,1),(300-33600),(300-33600),(300-56000),(300- 56000)</p>

Command: B CCITT or Bell

If the modem is configured so that it allows both options, the modem selects Bell or CCITT modulation for a connection with a speed of 300 or 1200 bps. Every other connection uses a CCITT standard modulation. If it is valid, the parameter value is rewritten to S27 bit 6.

Command	Default setting	Values defined	Result codes
B	0	B0	OK otherwise ERROR
		B1	

10.3.5 Data compression commands

Command: %C**Activate/deactivate data compression**

Activates or deactivates the setting for data compression. The modem can only execute data compression on an error-free connection. If it is valid, the parameter value is rewritten to S41 bits 0 and 1.

Command	Default setting	Values defined	Result codes	
%C		%C0	Deactivates data compression. Resets S46 bit 1.	OK ERROR
		%C1	Activates MNP 5 data compression setting. Resets S46 bit 1.	
		%C2	Activates V. 42bis data compression. Resets S46 bit 1.	
		%C3	Activates both V.42 bis and MNP 5 data compression. Sets S46 bit 1 (default setting).	

10.3.6 S-register

Certain modem values or parameters are stored in memory locations, the so-called S-registers. Use the S-commands (not described in this manual) to read or alter the contents of S-registers (see previous section). *Register values can be stored on one of two user profiles by means of the &W-command.

Register	Unit	Range	Default setting	Description
S0	1 bell signal	0 - 255	0	Number of bell signals to the automatic response: Sets the number of bell signals until the modem responds. ATSO=0 completely deactivates the automatic response. *
S3	Decimal	0 - 127	13 (^M)	Carriage return character: Defines the command line and the end character of the result code. Only refers to asynchronous operation.
S4	Decimal	0 - 127	10 (^J)	Line feed character: Defines the character that is identified as line feed. Only refers to asynchronous operation. The line feed control character is output after the return control character if long result codes are used.
S6	Seconds	2 - 255	2	Waiting time before blind dialling or for dial tone: 1. Defines the time in seconds for which the modem waits before it starts dialling after it has answered at blind dialling. This operation, however, can be influenced by some ATX options specified by country restrictions. The "waiting for dial tone" call progress feature (W-dial modifier in the dial string) overwrites the value in register S6 (if configured for the USA). 2. Defines the time in seconds for which the modem waits for the dial tone if it detects a "W" dial modifier and before it reports a NO DIAL TONE result code. (W class). The default setting depends on the respective country. The modem always pauses for at least 2 seconds, even if the value of S6 is less than 2 seconds. *
S7	Seconds	1 - 255*	50	Waiting time for carrier, silence or dial tone: 1. Defines the time in seconds for which the modem waits for the carrier before it hangs up. The timer is started when the modem stops the dialling process (originate), or 2 seconds after it has answered (respond). In "Originate" mode, the timer is always reset when an answer tone is detected, if this is permitted by the country restrictions. 2. Defines the time in seconds for which the modem waits for silence if it encounters the @ dial modifier before it continues with the next dial string parameter. 3. Defines the time in seconds for which the modem waits for the dial tone if it encounters a "W" dial modifier before it continues with the next dial string parameter (USA model). The default setting depends on the respective country. *
S8	Seconds	2 - 255	2	Pause for dial delay: Defines the time in seconds for which the modem must pause if it encounters the , dial modifier in the dial string. *
S10	0.1 s	1 - 255	14	Lost carrier for hang up delay: Defines the time in tenths of a second for which the modem waits before it hangs up after a loss of the carrier. This allows for a temporary carrier loss without the local modem cancelling the connection. If register S10 is set to 255, the modem works as if a carrier is always present. * The current time period for which the modem waits before it cancels the connection is the value in register S10 minus the value in register S9. Therefore the S10 value must be greater than the S9 value, or the modem cancels the connection before it detects the carrier. Note: The following applies to the call waiting detection. If the modem is set to the USA country code and S10 >=16, the modem detects the call waiting tone and hangs up. If S10 <16, the modem does not detect the call waiting tone.

* Register values can be stored on one of the two user profiles with the &W commands.

11 Index

A

Application, as directed, 6
Application as directed, 6
Application range, 14
AT commands, 70

B

Baud rate, system bus (CAN). *Siehe* baud rate
Bus cable length, 25

C

C0002: Device commands, 58
C0099: Software version, 58
C0150: Status word, 58
C0200: Software ID, 59
C0350: CAN node address, 48
C0351: CAN baud rate, 49
C0351: Set baud rate, 49
C0358: Reset node, 50
C0359: Diagnostics of the bus status, 50
C0360: Diagnostics of the telegram counter, 51
C0361: Diagnostics bus load, 52
C1200: Parameter data channel operating mode, 52
C1201: Communication timeout (CAN), 53
C1202: Time limit for node search, 53
C1203: Repeat tests, 53
C1204: Password, 60
C1205: Callback phone number, 61
C1206: Modem initialisation, 62
C1207: Switch-over internal / external modem, 62
C1208: Country code, 63
C1209: Read out baud rate, 54
C1213: Fieldbus connection, 59
C1215: Automatic baud rate detection, 54
C1219: Activation of CAN device monitoring, 54
C1223: user name, 63
C1225: baud rate of the external modem, 64
C1226: modem reset, 64
C1227: Delay time for search telegrams, 55
Cable cross-section, 25

Cable specification, 24
Call control commands, 73
CAN bus connection, 24
CANopen objects, 45
CANopen objects implemented, 47
CANopen parameter channels, 42
CANopen RUN LED and ERROR LED, 65
CE conformity, 6
CE-typical drive system, 20
Code numbers, Access via the communication module, 42
Code numbers / index, Conversion, 42
Commands for the DEE modem, 72
Commissioning, 31
- Initial switch-on, 38
Commissioning with the system bus configurator, 32
Communication via CAN, 21
Communication via the diagnostic interface (9400), 22
Configuring the communication module, 35
Conformity, 6, 15
Connection for an external modem, 28
Connection for the CAN bus, 24
Connections, 11
Controls, 11

D

Data compression commands, 78
Data transfer, 41
Data transfer via modem, 44
Data transfer via the diagnostic interface, 43
Definition of notes used, 10
Description of the CANopen objects implemented, 56
Description of the codes relevant for CAN, 48
Description of the codes relevant for the modem, 60
Description of the general codes, 58
Device protection, 9, 18
Device type, 56
Diagnostic interface, 30
Displays, 11
Disposal, 7

E

Electrical installation, 20

Error register, 56

Examples

- Indexing of Lenze codes, 42
- Selection help for cable length / number of repeaters, 26

External modem (connection), 28

H

Hardware version, type code, 13

I

I-1000, device type, 56

I-1001, Error register, 56

I-1017, Producer heartbeat time, 56

I-1018, module device description, 57

Identification, 13

Index, Conversion, 42

Indexing of Lenze codes, 42

Initial switch-on, 38

Installation, 18

- electrical, 20
- mechanical, 19

Installation of required drivers, 33

Inverter

- application as directed, 6
- labelling, 6

L

Labelling, inverter, 6

LED status displays, 12

Legal regulations, 6

Lenze Codes, C1227, 55

Lenze codes, 45

- C00002, 58
- C0099, 58
- C0150, 58
- C0200, 59
- C0350, 48
- C0351, 49
- C0358, 50
- C0359, 50
- C0360, 51
- C0361, 52
- C1200, 52
- C1201, 53
- C1202, 53
- C1203, 53
- C1204, 60
- C1205, 61
- C1206, 62
- C1207, 62
- C1208, 63
- C1209, 54
- C1213, 59
- C1215, 54
- C1219, 54
- C1223, 63
- C1225, 64
- C1226, 64

Liability, 7

List of countries, 68

M

- Manufacturer, 6
- Mechanical installation, 19
- Modem control commands, 70
- Modem standards, 67
- Modular connecting cable, 29
- Modulation control commands, 75
- Module device description, 57

N

- Nameplate, 13
- Notes, definition, 10

P

- Pluggable terminal strip, Use, spring connection, 23
- Pluggable terminal strips, handling, 23
- Producer heartbeat time, 56
- Product description, 11
- Product features, 14
- Protection of persons, 9
- Protective insulation, 16

R

- Residual hazards, 9

S

- S-register, 79
- Safety instructions, 8
 - definition, 10
 - device- and application-specific, 9
 - layout, 10
- Selection help for cable length / number of repeaters, Example, 26
- Signalling, 38
- Signalling acc. to DR303-3, 40
- Signalling of the CANopen RUN LED and ERROR LED, 65
- Software version, type code, 13
- Specification of the transmission cable, 24
- Status LED, 12
- Switch on, initial, 38
- System bus (CAN), baud rate, 25, 26
- System bus configurator, 33
- System requirements, 32

T

- TAE connecting cable, 29
- Technical data, 15
- Telephone connection, 29
- Telephone socket, assignment, 29
- Terminal data, 23
- Transmission cable, specification, 24
- Troubleshooting and fault elimination, 65
- Type code, 13
 - finding, 13

V

- Validity of the documentation, 4
- Voltage supply, 23

W

- Warranty, 7
- Wiring according to EMC, 20



© 07/2014

Lenze Automation GmbH
Postfach 10 13 52, D-31763 Hameln
Hans-Lenze-Str. 1, D-31855 Aerzen
Germany



+49 5154 82-0



+49 5154 82-2800



lenze@lenze.com



www.lenze.com

Service

Lenze Service GmbH
Breslauer Straße 3, D-32699 Extertal

Germany



008000 2446877 (24 h helpline)



+49 5154 82-1112



service@lenze.com

EDSMF2181IB ■ 13468049 ■ EN ■ 3.0 ■ TD17

10 9 8 7 6 5 4 3 2 1