

EDB8220UE
00455315

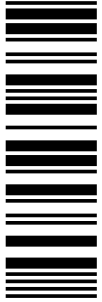

Lenze

Operating Instructions

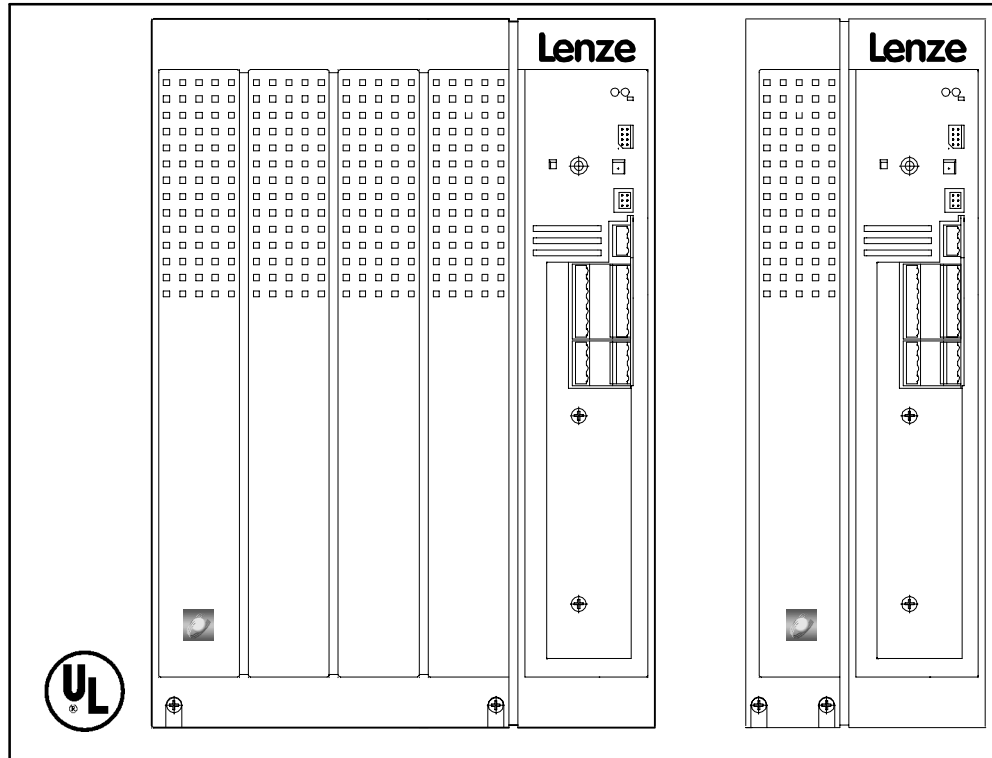

Global Drive

*8220/8240 frequency
inverters*

power range 0.37 ... 90 kW



These Operating Instructions are valid for the 82XX controllers of the versions:

	33.822X-	E	0x	0x		(8221 - 8227)
	33.822X-	E	1x	2x	-V003	Cold plate (8221 - 8222)
	33.824X-	E	1x	1x		(8241 - 8246)
	33.824X-	E	1x	1x	-V003	Cold plate (8241 - 8246)
Type						
Design: E = Enclosure IP20 IB = Module						
Hardware level and index						
Software level and index						
Variant						
Explanation						

		revised	revised
Edition of:	01/08/1997	04/2002	07/2002

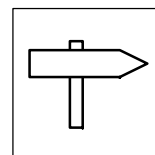

1	Preface and general information	1-1
1.1	How to use these Operating Instructions	1-1
1.1.1	Terminology used	1-1
1.1.2	What is new?	1-1
1.2	Scope of delivery	1-1
1.3	Legal regulations	1-2
2	Safety information	2-1
2.1	General safety information	2-1
2.2	Layout of the safety information	2-2
2.3	Residual hazards	2-2
3	Technical data	3-1
3.1	General data/application conditions	3-1
3.2	Rated data (operation with 150 % overload)	3-2
3.2.1	Types 8221 to 8224	3-2
3.2.2	Types 8225 to 8227	3-3
3.2.3	Types 8241 to 8243	3-4
3.2.4	Types 8244 to 8246	3-5
3.3	Rated data (operation with 120 % overload)	3-6
3.3.1	Operating conditions	3-6
3.3.2	Types 822X	3-6
3.3.3	Types 824X	3-6
3.4	Fuses and cable cross-sections for single drives	3-7
3.4.1	Operation of controllers in a UL-approved system	3-7
3.4.2	Operation with 150 % overload	3-7
3.4.3	Operation with 120 % overload	3-8
3.5	Dimensions	3-8
4	Installation	4-1
4.1	Mechanical installation	4-1
4.1.1	Important notes	4-1
4.1.2	Standard assembly with fixing brackets	4-2
4.1.3	Assembly of the variant 82XX-C-V003 "Cold Plate"	4-3
4.1.3.1	Assembly preparation	4-3
4.1.3.2	Assembly 822X-C-V003	4-3
4.1.3.3	Assembly 824X-C-V003	4-4
4.2	Electrical installation	4-5
4.2.1	Important notes	4-5
4.2.2	Power connections	4-6
4.2.2.1	Mains connection	4-6
4.2.2.2	Motor connection	4-7
4.2.2.3	Connection diagram	4-10
4.2.3	Control connections	4-11
4.2.3.1	Control cables	4-11
4.2.3.2	Assignment of the control terminals	4-12
4.2.3.3	Connection diagrams	4-13
4.3	Installation of a CE-typical drive system	4-14

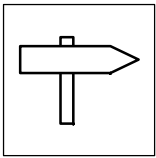

Contents

5	Commissioning	5-1
5.1	Before you switch on	5-1
5.2	Short set-up with factory setting	5-2
5.2.1	Switch-on sequence	5-2
5.2.2	Factory setting of the most important drive parameters ...	5-2
5.3	Adapt machine data	5-3
5.3.1	Determine speed range (fdmin, fdmax)	5-3
5.3.2	Adjustment of acceleration and deceleration times (Tir, Tif)	5-4
5.3.3	Setting of the current limit (Imax)	5-5
5.4	Optimize the operating characteristic of the drive	5-6
5.4.1	Select the control mode	5-6
5.4.2	Optimize control modes	5-8
5.4.2.1	Optimize motor-current control	5-8
5.4.2.2	Optimize V/f-characteristic control	5-9
6	During operation	6-1
7	Configuration	7-1
7.1	Basics	7-1
7.2	Code table	7-2
8	Troubleshooting and fault elimination	8-1
8.1	Troubleshooting	8-1
8.1.1	Display at the controller	8-1
8.1.2	Display at the operating module	8-1
8.1.3	Maloperation of the drive	8-2
8.2	Fault analysis using the history buffer	8-2
8.3	Fault indications	8-3
8.4	Reset of fault indications	8-5
9	Accessories (Survey)	9-1
9.1	Accessories for all types	9-1
9.2	Software	9-1
9.3	Type-specific accessories	9-2
9.3.1	Types 8221 - 8224	9-2
9.3.2	Types 8225 - 8227	9-2
9.3.3	Types 8241 - 8244	9-3
9.3.4	Types 8245 - 8246	9-3
10	Index	10-1

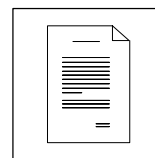

1 Preface and general information

1.1 How to use these Operating Instructions

- These Operating Instructions help you to connect and set up the 82XX frequency inverter. They contain safety information which must be observed.
- All persons who work on and with 82XX frequency inverters must have the Operating Instructions available and observe all relevant notes and instructions.
- The Operating Instructions must always be complete and perfectly readable.

1.1.1 Terminology used

Term	In the following text used for
82XX	Any frequency inverter of the series 8200, 8210, 8220, 8240
Controller	82XX frequency inverter
Drive system	Drive systems with 82XX frequency inverters and other Lenze drive components

1.1.2 What is new?

Material no.	Edition of	Important	Content
391577	28/08/1996		8240 Operating Instructions
397236	01/08/1997	replaces 391577	<ul style="list-style-type: none"> • Contents for 8220 and 8240 • Complete revision of the contents • Complete editorial revision
452539	04/2002	replaces 397236	<ul style="list-style-type: none"> • Chapter 4.2.3.2 • Chapter 5.1, 5.4.2.1 • Chapter 8.3
455315	07/2002	replaces 452539	<ul style="list-style-type: none"> • Change of company name • Chapter 8.3

1.2 Scope of delivery

Scope of delivery	Important
<ul style="list-style-type: none"> • 1 82XX frequency inverter • 1 Operating Instructions • 1 accessory kit (components for the mechanical and electric installation) 	<p>After the reception of the delivery, check immediately whether the scope of supply matches with the accompanying papers. Lenze does not accept any liability for deficiencies claimed subsequently.</p> <p>Claim</p> <ul style="list-style-type: none"> • visible transport damage immediately to the forwarder. • visible deficiencies/incompleteness immediately to your Lenze representative.

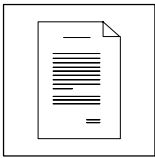

Preface and general information

1.3 Legal regulations

Labelling	Nameplate	CE mark	Manufacturer
	Lenze controllers are unambiguously designated by the content of the nameplate.	Conforms to the EC Low Voltage Directive	Lenze Drive Systems GmbH Postfach 101352 D-31763 Hameln
Application as directed	<p>82XX frequency inverter</p> <ul style="list-style-type: none"> • must only be operated under the conditions prescribed in these Instructions. • are components <ul style="list-style-type: none"> - for open and closed-loop control of variable speed drives with asynchronous standard motors, reluctance motors PM-synchronous motors with asynchronous damping cage - used for installation into a machine. - used for assembly together with other components to form a machine. • which are electric units for the installation into control cabinets or similar enclosed operating housing. • comply with the requirements of the Low-Voltage Directive. • are not machines for the purpose of the Machinery Directive. • are not to be used as appliances, but only for industrial purposes. <p>Drive systems with 82XX frequency inverters</p> <ul style="list-style-type: none"> • comply with the EMC Directive if they are installed according to the guidelines of CE-typical drive systems. • can be used <ul style="list-style-type: none"> - on public and non-public mains. - in industrial as well as residential and commercial premises. • The user is responsible for the compliance of his application with the EC directives. <p>Any other use shall be deemed inappropriate!</p>		
Liability	<ul style="list-style-type: none"> • The information, data and notes in these Operating Instructions met the state of the art at the time of printing. Claims referring to drive systems which have already been supplied cannot be derived from the information, illustrations, and descriptions given in these Operating Instructions. • The specifications, processes, and circuitry described in these Operating Instructions are for guidance only and must be adapted to your own specific application. Lenze does not take responsibility for the suitability of the process and circuit proposals. • The indications given in these Operating Instructions describe the features of the product without warranting them. • Lenze does not accept any liability for damage and operating interference caused by: <ul style="list-style-type: none"> - disregarding these Instructions - unauthorized modifications to the controller - operating errors - improper working on and with the controller 		
Warranty	<ul style="list-style-type: none"> • Warranty conditions: see Sales and Delivery Conditions of Lenze Drive Systems GmbH. • Warranty claims must be made immediately after detecting defects or faults. • The warranty is void in all cases where liability claims cannot be made. 		
Disposal	Material	recycle	dispose
	Metal	●	-
	Plastic	●	-
	Printed-board assemblies	-	●



2 Safety information

2.1 General safety information



Safety and application notes for controllers

(to: Low-Voltage Directive 73/23/EEC)

1. General

During operation, drive controllers may have, according to their type of protection, live, bare, in some cases also movable or rotating parts as well as hot surfaces.

Non-authorized removal of the required cover, inappropriate use, incorrect installation or operation, creates the risk of severe injury to persons or damage to material assets.

Further information can be obtained from the documentation.

All operations concerning transport, installation, and commissioning as well as maintenance must be carried out by qualified, skilled personnel (IEC 364 and CENELEC HD 384 or DIN VDE 0100 and IEC report 664 or DIN VDE 0110 and national regulations for the prevention of accidents must be observed).

According to this basic safety information qualified skilled personnel are persons who are familiar with the erection, assembly, commissioning, and operation of the product and who have the qualifications necessary for their occupation.

2. Application as directed

Drive controllers are components which are designed for installation in electrical systems or machinery.

When installing in machines, commissioning of the drive controllers (i.e. the starting of operation as directed) is prohibited until it is proven that the machine corresponds to the regulations of the EC Directive 89/392/EEC (Machinery Directive); EN 60204 must be observed.

Commissioning (i.e. starting of operation as directed) is only allowed when there is compliance with the EMC Directive (89/336/EEC).

The drive controllers meet the requirements of the Low Voltage Directive 73/23/EEC. The harmonized standards of the prEN 50178/ DIN VDE 0160 series together with EN 60439-1/DIN VDE 0660 part 500 and EN 60146/DIN VDE 0558 are applicable to drive controllers.

The technical data and information on the connection conditions must be obtained from the nameplate and the documentation and must be observed in all cases.

3. Transport, storage

Notes on transport, storage and appropriate handling must be observed.

Climatic conditions must be observed according to prEN 50178.

4. Erection

The devices must be erected and cooled according to the

regulations of the corresponding documentation.

The drive controllers must be protected from inappropriate loads. Particularly during transport and handling, components must not be bent and/or isolating distances must not be changed. Touching of electronic components and contacts must be avoided.

Drive controllers contain electrostatically sensitive components which can easily be damaged by inappropriate handling.

Electrical components must not be damaged or destroyed mechanically (health risks are possible!).

5. Electrical connection

When working on live drive controllers, the valid national regulations for the prevention of accidents (e.g. VBG 4) must be observed.

The electrical installation must be carried out according to the appropriate regulations (e.g. cable cross-sections, fuses, PE connection). More detailed information is included in the documentation.

Notes concerning the installation in compliance with EMC - such as screening, grounding, arrangement of filters and laying of cables - are included in the documentation of the drive controllers. These notes must also be observed in all cases for drive controllers with the CE mark. The compliance with the required limit values demanded by the EMC legislation is the responsibility of the manufacturer of the system or machine.

6. Operation

Systems where drive controllers are installed must be equipped, if necessary, with additional monitoring and protective devices according to the valid safety regulations, e.g. law on technical tools, regulations for the prevention of accidents, etc. Modifications of the drive controllers by the operating software are allowed.

After disconnecting the drive controllers from the supply voltage, live parts of the controller and power connections must not be touched immediately, because of possibly charged capacitors. For this, observe the corresponding labels on the drive controllers. During operation, all covers and doors must be closed.

7. Maintenance and servicing

The manufacturer's documentation must be observed.

This safety information must be kept!

The product-specific safety and application notes in these Operating Instructions must also be observed!



Safety information





2.2 Layout of the safety information

- All safety notes have a uniform layout:
 - The icon characterizes the type of danger.
 - The signal word characterizes the severity of danger.
 - The note describes the danger and suggests how to avoid the danger.



Signal word

Note

	Icons used		Signal words	
Warning of danger to persons		Warning of hazardous electrical voltage	Danger!	Warns of impending danger . Consequences if disregarded: Death or very severe injuries.
		Warning of a general danger	Warning!	Warns of potential, very hazardous situations . Possible consequences if disregarded: Death or very severe injuries.
Warning of damage to material			Caution!	Warns of potential, hazardous situations . Possible consequences if disregarded: Light or minor injuries.
			Stop!	Warns of potential damage to material . Possible consequences if disregarded: Damage of the controller/drive system or its environment.
Other notes			Note!	This note designates general, useful notes. If you observe it, handling of the controller/drive system is made easier.

2.3 Residual hazards

Operator's safety	After mains disconnections, the power terminals U, V, W and +U _G , -U _G remain live for at least three minutes. <ul style="list-style-type: none"> • Before working on the controller, check that no voltage is applied to the power terminals.
Protection of devices	Cyclic connection and disconnection of the controller supply voltage at L1, L2, L3 or +U _G , -U _G may overload the internal input current load: <ul style="list-style-type: none"> • Allow at least 3 minutes between disconnection and reconnection.
Overspeeds	Drive systems can reach dangerous overspeeds (e. g. setting of inappropriately high field frequencies): <ul style="list-style-type: none"> • The controllers do not offer any protection against these operating conditions. Use additional components for this.

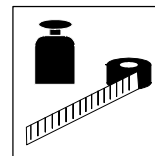

3 Technical data

3.1 General data/application conditions

Field	Values		
Vibration resistance	Germanischer Lloyd, general conditions		
Permissible moisture	Humidity class F without condensation (average relative humidity 85 %)		
Permissible temperature ranges	during transport of the controller: -25 °C ... +70 °C		
	during storage of the controller: -25 °C ... +55 °C		
	during operation of the controller: 0 °C ... +40 °C without power derating +40 °C ... +50 °C with power derating		
Permissible installation height h	h ≤ 1000 m amsl without power derating		
	1000 m amsl < h ≤ 4000 m amsl with power derating		
Degree of pollution	VDE 0110 part 2 pollution degree 2		
Noise emission	Requirements acc. to EN 50081-2, EN 50082-1, IEC 22G-WG4 (Cv) 21 Limit value class A to EN 55011 (industrial area) with mains filter Limit value class B to EN 55022 (residential area) with mains filter and installation into control cabinet		
Noise immunity	Limit values maintained using mains filter. Requirements acc. to EN 50082-2, IEC 22G-WG4 (Cv) 21		
	Requirements	Standard	Severities
	ESD	EN61000-4-2	3, i.e. 8 kV with air discharge 6 kV with contact discharge
	RF interference(enclosure)	EN61000-4-3	3, i.e. 10V/m; 27 to 1000MHz
	Burst	EN61000-4-4	3/4, i.e. 2 kV/5 kHz
Surge (surge on mains cable)	EN 61000-4-5	3, i.e. 1.2/50 μs, 1 kV phase-phase, 2 kV phase-PE	
Insulation strength	Overvoltage category III according to VDE 0110		
Packaging to DIN 4180	Types 824X	Dust packaging	
	Types 822X	Transport packaging	
Type of protection		IP20 NEMA 1: Protection against contact	
		IP 41 on the heat-sink side with thermal separation in push-through technique	
Approvals	CE:	Low-Voltage Directive and Electromagnetic Compatibility	
	UL 508: UL 508C:	Industrial Control Equipment Power Conversion Equipment	

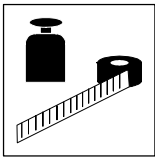

Technical Data

3.2 Rated data (operation with 150 % overload)

3.2.1 Types 8221 to 8224

150 % overload		Type	8221	8222	8223	8224					
		Order no.	EVF8221-E	EVF8222-E	EVF8223-E	EVF8224-E					
Variant "Cold Plate"		Type	8221-V003	8222-V003							
		Order no.	EVF8221-C-V003	EVF8222-C-V003							
Mains voltage		V_N [V]	320 V - 0% ≤ V_N ≤ 528 V + 0% ; 45 Hz ... 65 Hz ± 0%								
Alternative DC supply		V_G [V]	460 V - 0% ≤ V_G ≤ 740 V + 0%								
Mains current with mains filter/mains choke without mains filter/mains choke		I_{mains} [A]	29.0	42.0	55.0	80.0					
		I_{mains} [A]	43.5	--	--	--					
Data for mains operation with 3 AC/400 V/50 Hz/60 Hz ; 460 V ≤ V_G ≤ 725 V or 3 AC/480 V/50 Hz/60 Hz ; 460 V ≤ V_G ≤ 765 V											
			400 V	480 V	400 V	480 V	400 V	480 V	400 V	480 V	
Motor power (4 pole ASM) at 4kHz/8kHz*		P_N [kW]	15	18.5	22	30	30	37	45	55	
		P_N [hp]	20	25	30	40	40	49.5	60	74	
Output power U, V, W at 4 kHz/8 kHz*		S_{N8} [kVA]	22.2	26.6	32.6	39.1	41.6	49.9	61.7	73.9	
Power output + U_G , - U_G ¹⁾		P_{DC} [kW]	10.2	11.8	4.0	4.6	0	0	5.1	5.9	
Output current	4 kHz*	I_{N4} [A]	32	32	47	47	59	56	89	84	
	8 kHz*	I_{N8} [A]	32	32	47	47	59	56	89	84	
	12 kHz*	I_{N12} [A]	27	25	40	37	50	47	71	67	
	16 kHz*	I_{N16} [A]	24	22	35	33	44	41	62	58	
	noise optimized 12 kHz*	I_{N12} [A]	25	24	37	35	44	38	62	58	
	noise optimized 16 kHz*	I_{N16} [A]	21	19	30	28	35	30	53	49	
Max. output current for 60s ²⁾	4 kHz*	$I_{N\text{max}4}$ [A]	48	48	70.5	70.5	89	84	134	126	
	8 kHz*	$I_{N\text{max}8}$ [A]	48	48	70.5	70.5	89	84	134	126	
	12 kHz*	$I_{N\text{max}12}$ [A]	40	38	59	56	75	70	92	87	
	16 kHz*	$I_{N\text{max}16}$ [A]	36	33	53	49	66	61	81	75	
	noise optimized 12 kHz*	$I_{N\text{max}12}$ [A]	38	36	56	53	66	57	81	75	
	noise optimized 16 kHz*	$I_{N\text{max}16}$ [A]	31	29	46	42	53	45	69	63	
Motor voltage ³⁾		V_M [V]	0 - 3 × V_{mains} / 0Hz ... 50Hz, selectable up to 480Hz								
Power loss (operation with I_{Nk})		P_v [W]	430	640	810	1100					
Power derating		[%/K] [%/m]	40 °C < T_{amb} < 50 °C: 2.5%/K 1000 m amsl < h ≤ 4000 m amsl: 5%/1000m								
Field frequency	Resolution	absolute	0.02 Hz								
	Digital setpoint selection	Accuracy	± 0.05 Hz								
	Analog setpoint selection	Linearity	± 0.5 % (max. selected signal level: 5 V or 10 V)								
		Temperature sensitivity	0 ... 40 °C: +0.4 %								
		Offset	± 0 %								
Weight "Cold Plate" without heat sink		m [kg]	15 11	15 11	15 -	33.5 -					

Printed in bold: Data for the operation with factory setting and a chopper frequency of 8 kHz.

- 1) This power can be additionally obtained when operating a matching motor
- 2) The currents apply to a periodical load cycle with 1 minute overcurrent with the current mentioned here and 2 minutes base load with 75% I_{Nk}
- 3) With mains choke/mains filter: max. output voltage = ca. 96 % of the mains voltage
- * Chopper frequency of the inverter

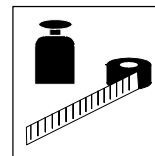

3.2.2 Types 8225 to 8227

150 % overload		Type	8225		8226		8227	
		Order no.	EVF8225-E		EVF8226-E		EVF8227-E	
Mains voltage		V_N [V]	320 V - 0% $\leq V_N \leq$ 528 V + 0% ; 45 Hz ... 65 Hz \pm 0%					
Alternative DC supply		V_G [V]	460 V - 0% $\leq V_G \leq$ 740 V + 0%					
Mains current with mains filter/mains choke without mains filter/mains choke		I_{mains} [A]	100		135		165	
		I_{mains} [A]	--		--		--	
Data for mains operation with 3 AC/400 V/50 Hz/60 Hz ; 460 V $\leq V_G \leq$ 725 V or 3 AC/480 V/50 Hz/60 Hz ; 460 V $\leq V_G \leq$ 765 V								
			400 V	480 V	400 V	480 V	400 V	480 V
Motor power (4 pole ASM) at 4 kHz/8 kHz*		P_N [kW]	55	75	75	90	90	110
		P_N [hp]	74	100	100	120	120	148
Output power U, V, W at 4kHz/8 kHz*		S_{N8} [kVA]	76.2	91.4	103.9	124	124.7	149
Power output + U_G , - U_G ¹⁾		P_{DC} [kW]	0	0	28.1	32.4	40.8	47.1
Output current	4 kHz*	I_{N4} [A]	110	105	150	142	180	171
	8 kHz*	I_{N8} [A]	110	105	150	142	171	162
	12 kHz*	I_{N12} [A]	88	83	120	112	126	117
	16 kHz*	I_{N16} [A]	77	72	105	98	108	99
	noise optimized 12 kHz*	I_{N12} [A]	66	60	82	75	90	81
	noise optimized 16 kHz*	I_{N16} [A]	60	55	67	60	72	63
Max. output current for 60s ²⁾	4 kHz*	$I_{N\text{max}4}$ [A]	165	157	225	213	270	256
	8 kHz*	$I_{N\text{max}8}$ [A]	165	157	225	213	221	211
	12 kHz*	$I_{N\text{max}12}$ [A]	114	108	156	147	164	153
	16 kHz*	$I_{N\text{max}16}$ [A]	100	94	136	128	140	130
	noise optimized 12 kHz*	$I_{N\text{max}12}$ [A]	85	78	107	98	117	106
	noise optimized 16 kHz*	$I_{N\text{max}16}$ [A]	78	72	87	78	94	83
Motor voltage ³⁾		V_M [V]	0 - 3 $\times V_{\text{mains}}$ / 0Hz ... 50Hz, selectable up to 480Hz					
Power loss (operation with I_{N8})		P_V [W]	1470		1960		2400	
Power derating		[%/K] [%/m]	40 °C < T_{amb} < 50 °C: 2.5%/K 1000 m amsl < h \leq 4000 m amsl: 5%/1000m					
Field frequency	Resolution	absolute	0.02 Hz					
	Digital setpoint selection	Accuracy	\pm 0.05 Hz					
	Analog setpoint selection	Linearity	\pm 0.5 % (max. selected signal level: 5 V or 10 V)					
		Temperature sensitivity	0 ... 40 °C: +0.4 %					
	Offset	\pm 0 %						
Weight		m [kg]	36.5		59		59	

Printed in bold: Data for the operation with factory setting and a chopper frequency of 8 kHz.

- 1) This power can be additionally obtained when operating a matching motor
- 2) The currents apply to a periodical load cycle with 1 minute overcurrent with the current mentioned here and 2 minutes base load with 75% I_{N8}
- 3) With mains choke/mains filter: max. output voltage = ca. 96 % of the mains voltage
- * Chopper frequency of the inverter

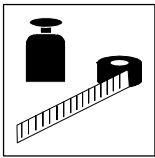

Technical Data

3.2.3 Types 8241 to 8243

150 % overload		Type	8241		8242		8243	
		Order no.	EVF8241-E		EVF8242-E		EVF8243-E	
Variant "Cold Plate"		Type	8241-V003		8242-V003		8243-V003	
		Order no.	EVF8241-C-V003		EVF8242-C-V003		EVF8243-C-V003	
Mains voltage		V_N [V]	320V \pm 0% $\leq V_N \leq$ 528V \pm 0%; 45Hz ... 65Hz \pm 0%					
Alternative DC supply		V_G [V]	460V \pm 0% $\leq V_G \leq$ 740V \pm 0%					
Mains current with mains filter/mains choke without mains filter/mains choke		I_{mains} [A]	1.5		2.5		3.9	
		I_{mains} [A]	2.1		3.5		5.5	
Data for mains operation with 3 AC/400 V/50 Hz/60 Hz; 460 V $\leq V_G \leq$ 725 V or 3 AC/480 V/50 Hz/60 Hz; 460 V $\leq V_G \leq$ 765 V								
Motor power (4 pole ASM) at 4 kHz/8 kHz*		P_N [kW]	400 V	480 V	400 V	480 V	400 V	480 V
		P_N [hp]	0.37	0.37	0.75	0.75	1.5	1.5
Output power U, V, W at 4kHz/8 kHz*		S_{N8} [kVA]	0.5	0.5	1.0	1.0	2.0	2.0
		S_{N8} [kVA]	1.0	1.2	1.7	2.1	2.7	3.2
Power output + U_G , - U_G ¹⁾		P_{DC} [kW]	1.9	2.3	0.7	0.9	0	0
Output current	4 kHz*	I_{N8} [A]	1.5	1.5	2.5	2.5	3.9	3.9
	8 kHz*	I_{N8} [A]	1.5	1.5	2.5	2.5	3.9	3.9
	12kHz*	I_{N12} [A]	1.35	1.35	2.2	2.2	3.5	3.5
	16 kHz*	I_{N16} [A]	1.2	1.2	2.0	2.0	3.1	3.1
	noise optimized 12 kHz*	I_{N12} [A]	1.3	1.3	2.1	2.1	3.4	3.4
	noise optimized 16 kHz*	I_{N16} [A]	1.1	1.1	1.8	1.8	2.9	2.9
Max. output current for 60s ²⁾	4 kHz*	$I_{N\text{max}8}$ [A]	2.2	2.25	3.7	3.75	5.8	5.85
	8 kHz*	$I_{N\text{max}8}$ [A]	2.2	2.25	3.7	3.75	5.8	5.85
	12 kHz*	$I_{N\text{max}12}$ [A]	2.0	2.0	3.3	3.3	5.2	5.2
	16 kHz*	$I_{N\text{max}16}$ [A]	1.8	1.8	3.0	3.0	4.7	4.7
	noise optimized 12 kHz*	$I_{N\text{max}12}$ [A]	1.9	1.9	3.2	3.2	5.1	5.1
	noise optimized 16 kHz*	$I_{N\text{max}16}$ [A]	1.6	1.6	2.7	2.7	4.3	4.3
Motor voltage ³⁾		V_M [V]	0 - 3 $\times V_{\text{mains}}$ / 0Hz ... 50Hz, selectable up to 480Hz					
Power loss (operation with I_{N8})		P_V [W]	50		65		100	
Power derating		$[\%/K]$ $[\%/m]$	40 °C < T_{amb} < 50 °C: 2.5%/K 1000 m amsl < h \leq 4000 m amsl: 5%/1000m					
Field frequency	Resolution	absolute	0.02 Hz					
	Digital setpoint selection	Accuracy	\pm 0.05 Hz					
	Analog setpoint selection	Linearity	\pm 0.5 % (max. selected signal level: 5 V or 10 V)					
		Temperature sensitivity	0 ... 40 °C: +0.4 %					
		Offset	\pm 0 %					
Weight "Cold Plate" without heat sink		m [kg]	3.5		3.5		5.0	

Printed in bold: Data for the operation with factory setting and a chopper frequency of 8 kHz.

- 1) This power can be additionally obtained when operating a matching motor
- 2) The currents apply to a periodical load cycle with 1 minute overcurrent with the current mentioned here and 2 minutes base load with 75% I_{N8}
- 3) With mains choke/mains filter: max. output voltage = ca. 96 % of the mains voltage
- * Chopper frequency of the inverter

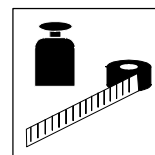

3.2.4 Types 8244 to 8246

150 % overload		Type	8244	8245	8246				
		Order no.	EVF8244-E	EVF8245-E	EVF8246-E				
Variant "Cold Plate"		Type	8244-V003	8245-V003	8246-V003				
		Order no.	EVF8244-C-V003	EVF8245-C-V003	EVF8246-C-V003				
Mains voltage		V_N [V]	320V \pm 0% $\leq V_N \leq$ 528V \pm 0% ; 45Hz ... 65Hz \pm 0%						
Alternative DC supply		V_G [V]	460V \pm 0% $\leq V_G \leq$ 740V \pm 0%						
Mains current with mains filter/mains choke		I_{mains} [A]	7.0	12.0	20.5				
without mains filter/mains choke		I_{mains} [A]	-	16.8	-				
Data for mains operation with 3 AC/400 V/50 Hz/60 Hz ; 460 V $\leq V_G \leq$ 725 V or 3 AC/480 V/50 Hz/60 Hz ; 460 V $\leq V_G \leq$ 765 V									
			400 V	480 V	400 V	480 V	400 V	480 V	
Motor power (4 pole ASM) at 4 kHz/8 kHz*		P_N [kW]	3.0	3.0	5.5	5.5	11.0	11.0	
		P_N [hp]	4.0	4.0	7.5	7.5	15.0	15.0	
Output power U, V, W at 4kHz/8 kHz*		S_{N8} [kVA]	4.8	5.8	9.0	10.8	16.3	10.8	
Power output + U_G , - U_G ¹⁾		P_{DC} [kW]	2.0	2.5	0	0	0	0	
Output current	4 kHz*	I_{N4} [A]	7.0	7.0	13.0	13.0	23.5	23.5	
	8 kHz*	I_{N8} [A]	7.0	7.0	13.0	13.0	23.5	23.5	
	12 kHz*	I_{N12} [A]	6.3	6.3	11.7	11.7	20.0	19.1	
	16 kHz*	I_{N16} [A]	5.6	5.6	10.4	10.4	16.5	15.7	
	noise optimized 12 kHz*	I_{N12} [A]	6.1	6.1	11.3	11.3	19.4	18.4	
	noise optimized 16 kHz*	I_{N16} [A]	5.2	5.2	9.7	9.7	15.2	14.6	
Max. output current for 60s ²⁾	4 kHz*	I_{Nmax8} [A]	10.5	10.5	19.5	19.5	35.0	33.5	
	8 kHz*	I_{Nmax8} [A]	10.5	10.5	19.5	19.5	35.0	33.5	
	12 kHz*	I_{Nmax12} [A]	9.5	9.5	17.5	17.5	30.0	28.7	
	16 kHz*	I_{Nmax16} [A]	8.4	8.4	15.6	15.6	24.6	23.6	
	noise optimized 12 kHz*	I_{Nmax12} [A]	9.1	9.1	16.5	16.5	29.0	27.6	
	noise optimized 16 kHz*	I_{Nmax16} [A]	7.8	7.8	14.5	14.5	22.9	21.8	
Motor voltage ³⁾		V_M [V]	0 - 3 $\times V_{mains}$ / 0Hz ... 50Hz, selectable up to 480Hz						
Power loss (operation with I_{Nx})		P_V [W]	150		210		360		
Power derating		[%/K] [%/m]	40 °C < T_{amb} < 50 °C: 2.5%/K 1000 m amsl < h \leq 4000 m amsl: 5%/1000m						
Field frequency	Resolution	absolute	0.02 Hz						
	Digital setpoint selection	Accuracy	\pm 0.05 Hz						
	Analog setpoint selection	Linearity	\pm 0.5 % (max. selected signal level: 5 V or 10 V)						
		Temperature sensitivity	0 ... 40 °C: +0.4 %						
		Offset	\pm 0 %						
Weight "Cold Plate" without heat sink		m [kg]	5.0	7.5	7.5				

Printed in bold: Data for the operation with factory setting and a chopper frequency of 8 kHz.

- 1) This power can be additionally obtained when operating a matching motor
- 2) The currents apply to a periodical load cycle with 1 minute overcurrent with the current mentioned here and 2 minutes base load with 75% I_{Nx}
- 3) With mains choke/mains filter: max. output voltage = ca. 96 % of the mains voltage
- * Chopper frequency of the inverter

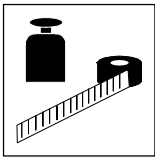

Technical Data

3.3 Rated data (operation with 120 % overload)

3.3.1 Operating conditions

- Applications:
 - Pumps with square characteristic
 - Fans
- Operation only
 - with mains filter or mains choke.
 - with a mains voltage of 3 AC / 400 V / 50 Hz/60 Hz.
- Automatic chopper-frequency derating to 4 kHz.
- Adapt mains-side accessories to the increased mains current:
 - For fuses and cable cross-sections see chapter 3.4.3.
 - For data of other components see "Accessories".

3.3.2 Types 822X

120 % overload	Type	8221	8222	8223*	8224	8225*	8226	8227*
Mains current with mains filter/mains choke	I_{mains} [A]	39.0	50.0	60.0	97.0	119	145	185
Data for mains operation with 3 AC / 400 V / 50 Hz/60 Hz ; $460 \text{ V} \leq V_G \leq 725 \text{ V}$								
Motor power (4-pole ASM)	P_N [kW]	22	30	37,5	55	75	90	110
	P_N [hp]	30	40	50	74	100	120	148
Output power U, V, W	S_{N4} [kVA]	29.8	39.5	46.4	74.8	91.5	110	142
Output current	I_{N4} [A]	43	56	66	100	132	159	205
Max. output current for für 60s	$I_{N\text{max}4}$ [A]	50	70.5	89	134	165	225	270
Power loss (operation with I_{N4})	P_V [W]	640	810	810	1350	1470	2100	2400

* Max. permissible ambient operating temperature + 35 °C
For other data see chapter 3.2.1 and chapter 3.2.2.

3.3.3 Types 824X

120 % overload	Type	8241	8242	8243	8244	8245	8246
Mains current With mains choke	I_{mains} [A]	1.7	2.8	5.0	8.8	15.0	20.5
Data for mains operation with 3 AC / 400 V / 50 Hz/60 Hz ; $460 \text{ V} \leq V_G \leq 725 \text{ V}$							
Motor power (4-pole ASM)	P_N [kW]	0.55	1.1	2.2	4.0	7.5	11.0
	P_N [hp]	0.75	1.5	2.9	5.4	10.0	15.0
Output power U, V, W	S_{N4} [kVA]	1.3	2.1	3.8	6.5	11.1	16.3
Output current	I_{N4} [A]	1.8	3.1	5.5	9.2	16.0	23.5
Max. output current for für 60s	$I_{N\text{max}4}$ [A]	2.25	3.75	6.6	11.0	19.5	35.3
Power loss (operation with I_{N4})	P_V [W]	50	65	115	165	260	360

For other data see chapter 3.2.3 and chapter 3.2.4.

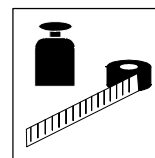

3.4 Fuses and cable cross-sections for single drives

3.4.1 Operation of controllers in a UL-approved system

- Use only UL-approved fuses and fuse holders:
 - 500 V to 600 V in the mains input (AC, F1 ... F3).
 - 700 V in the voltage DC bus (DC, F4/F5).
 - Activation characteristic "H" or "K5"
- Only use UL-approved cables

3.4.2 Operation with 150 % overload

The table values are valid for the operation of 82XX controllers as single drives with a matching motor and 150 % overload.

Type	Mains input L1, L2, L3, PE/motor connection U, V, W, PE									
	Operation without mains filter/mains choke					Operation with mains filter/mains choke				
	Fuse F1, F2, F3		E.l.c.b.	Cable cross-section ¹⁾		Fuse F1, F2, F3		E.l.c.b.	Cable cross-section ¹⁾	
VDE	UL	VDE	mm ²	AWG	VDE	UL	VDE	mm ²	AWG	
8221	63A	--	--	16	5	M 35A	35A	--	10	7
8222	--	--	--	--	--	M 50A	50A	--	16	5
8223	--	--	--	--	--	M 80A	80A	--	25	3
8224	--	--	--	--	--	M 100A	100A	--	50	0
8225	--	--	--	--	--	M 125A	125A	--	70	2 / 0
8226	--	--	--	--	--	M 160A	175A	--	95	3 / 0
8227	--	--	--	--	--	M 200A	200A	--	120	4 / 0
8241	M 6A	5A	B 6A	1	17	M 6A	5A	B 6A	1	17
8242	M 6A	5A	B 6A	1	17	M 6A	5A	B 6A	1	17
8243	M 10A	10A	B 10A	1.5	15	M 10A	10A	B 10A	1.5	15
8244	--	--	--	--	--	M 10A	10A	B 10A	1.5	15
8245	M 25A	25A	B 25A	6	10	M 20A	20A	B 20A	4	11
8246	--	--	--	--	--	M 32A	25A	B 32A	6	10

¹⁾ Observe national and regional regulations (e. g. VDE/EVU)!

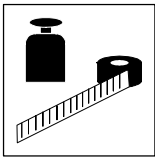

Technical Data

3.4.3 Operation with 120 % overload

The table values are valid for the operation of 82XX controllers as single drives with a matching motor and 120 % overload in pump and fan drives.

Type	Mains input L1, L2, L3, PE/motor connection U, V, W, PE				
	Operation with mains filter/choke only				
	Fuse F1, F2, F3		E.l.c.b.	Cable cross-section ¹⁾	
	VDE	UL	VDE	mm ²	AWG
8221	M 50A	50A	--	16	5
8222	M 63A	63A	--	25	3
8223	M 80A	80A	--	25	3
8224	M 125A	125A	--	70	2 / 0
8225	M 160A	175A	--	95	3 / 0
8226	M 160A	175A	--	95	3 / 0
8227	M 200A	200A	--	120	4 / 0
8241	M 6A	5A	B 6A	1	17
8242	M 6A	5A	B 6A	1	17
8243	M 10A	10A	B 10A	1.5	15
8244	M 10A	10A	B 10A	1.5	15
8245	M 20A	20A	B 20A	4	11
8246	M 32A	25A	B 32A	6	10

¹⁾ Observe national and regional regulations (e. g. VDE/EVU)!

3.5 Dimensions

The controller dimensions depend on the mechanical installation (see chapter 4.1).

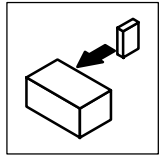

4 Installation

4.1 Mechanical installation

4.1.1 Important notes

- Use the controllers only as built-in devices!
- If the cooling air contains pollutants (dust, fluff, grease, aggressive gases):
 - take suitable preventive measures , e.g. separate air duct, installation of filters, regular cleaning, etc.
- Observe free space!
 - You can install several controllers next to each other without free space in a control cabinet.
 - Ensure unimpeded ventilation of cooling air and outlet of exhaust air!
 - Allow a free space of 100 mm at the top and at the bottom.
- Do not exceed the ambient temperature permissible during operation (see chapter. 3.1)
- With continuous oscillations or vibrations:
 - Check whether shock absorbers are necessary.

Possible mounting positions

- In vertical position at the back of the control cabinet, terminals point to the front:
 - With attached fixing brackets.
 - Thermally separated with external heat sink ("push-through technology").
 - Variant V003 thermally separated with external cooler in "Cold plate technique" (e.g. with convection cooler).

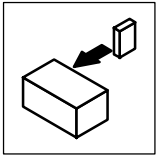

Installation

4.1.2 Standard assembly with fixing brackets

822X assembly preparations (see FIG 4-1)	
To assemble and install the controller it is necessary to remove the unit cover. The accessory kit inside the controller contains the parts required for the assembly and installation.	<ol style="list-style-type: none"> 1. Loosen screws (x). 2. Swing cover to the top and detach. 3. Bolt the fixing brackets onto the housing.

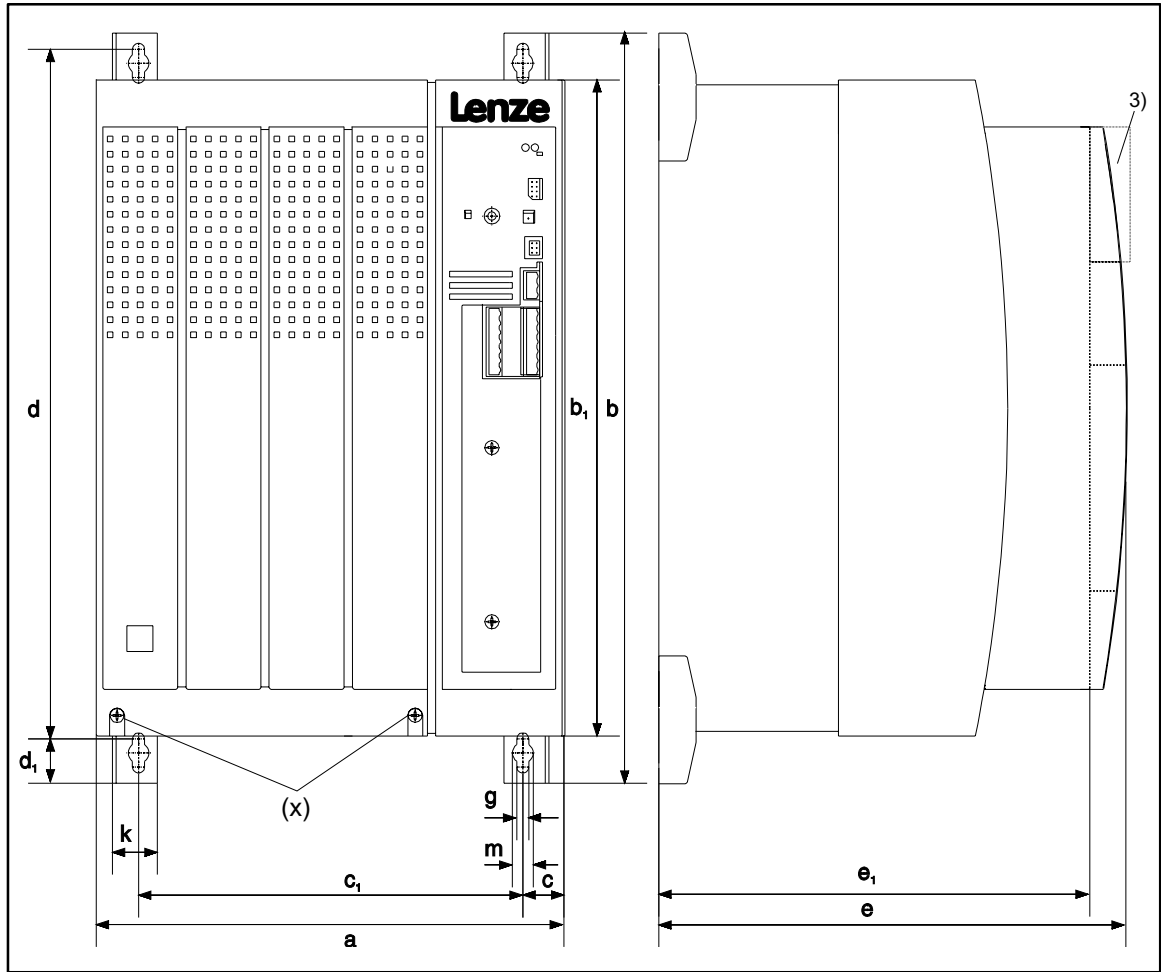
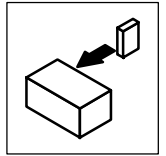

FIG 4-1 Dimensions - standard assembly

3) With attachable fieldbus or I/O module:
Observe assembly depth and assembly space required for connection cables

[mm]	a	b	b1	c	c1	d	d1	e ³⁾	e1	g	k	m
8221 / 8222 / 8223	250	402	350	22	206	370	24	250	230	6.5	24	11
8224	340	580	510	28.5	283	532	38	285	265	11	24	18
8225	340	672	591	28.5	283	624	38	285	265	11	28	18
8226 / 8227	450	748.5	680	30.5	389	702	38	285	265	11	28	18
8241 / 8242	78	384	350	39	-	365	-	250	230	6.5	30	-
8243 / 8244	97	384	350	48.5	-	365	-	250	230	6.5	30	-
8245 / 8246	135	384	350	21.5	92	365	-	250	230	6.5	30	-



4.1.3 Assembly of the variant 82XX-C-V003 "Cold Plate"

4.1.3.1 Assembly preparation

Apply the heat-conducting paste before you bolt the cooler onto the cold plate of the controller to reduce the heat-transfer resistance to a minimum. The heat-conducting paste included in the assembly kit is enough for approx. 1000 cm²:

1. Clean the contact surfaces of the cooler and cold plate with ethyl alcohol.
2. Apply the heat-conducting paste thinly with a scraper or brush.

4.1.3.2 Assembly 822X-C-V003

- Fix the controller to the heat sink using the fixing screws M5 x 25.
- Tightening torque: 3.4 Nm.

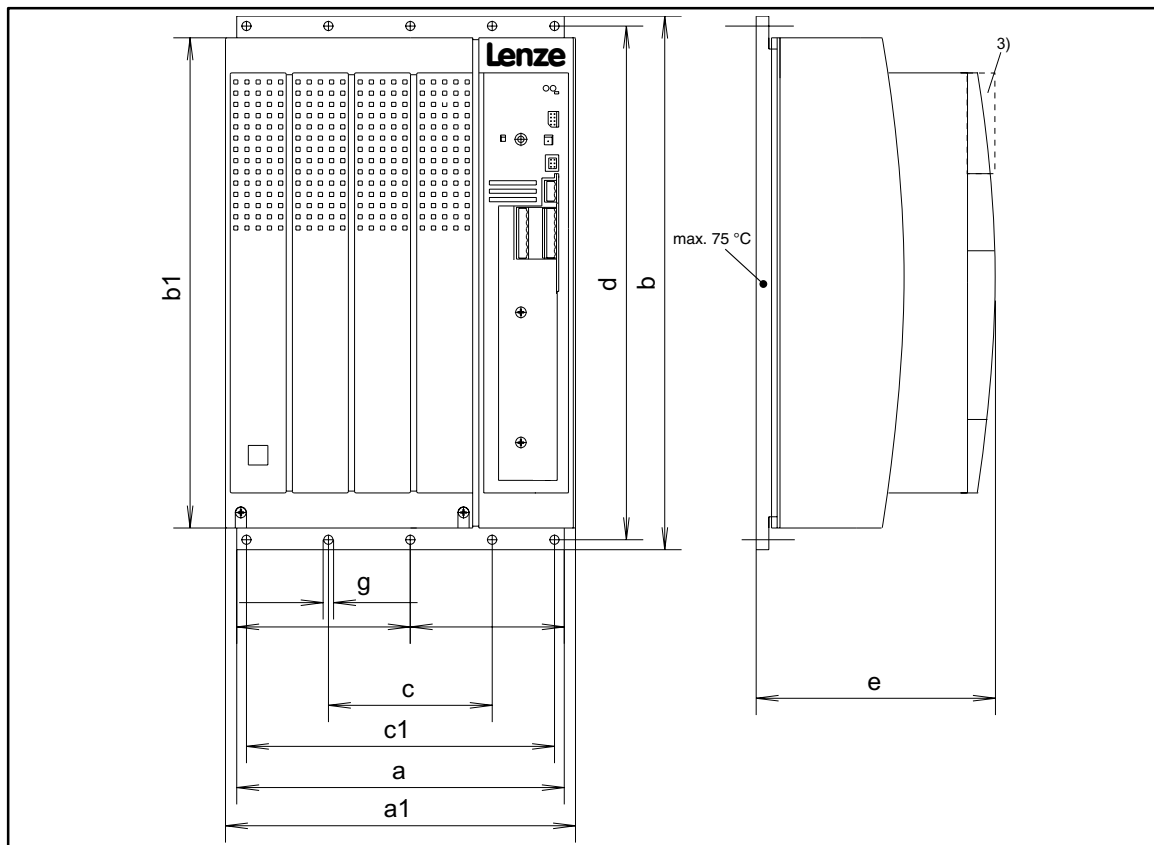
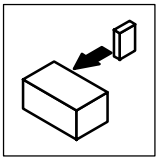

FIG 4-2 Dimensions 822X-C-V003: Control-cabinet assembly

3) With attachable fieldbus or I/O module:
Observe assembly depth and assembly space required for connection cables

[mm]	a	a1	b	b1	c	c1	d	e ³⁾	g
8221-V003	234	250	381	350	110	220	367	171	6.5
8222-V003									



Installation

4.1.3.3 Assembly 824X-C-V003

- Fix the controller to the heat sink using the fixing brackets and the fixing screws M5 x 20.
- Tightening torque: 3.4 Nm.

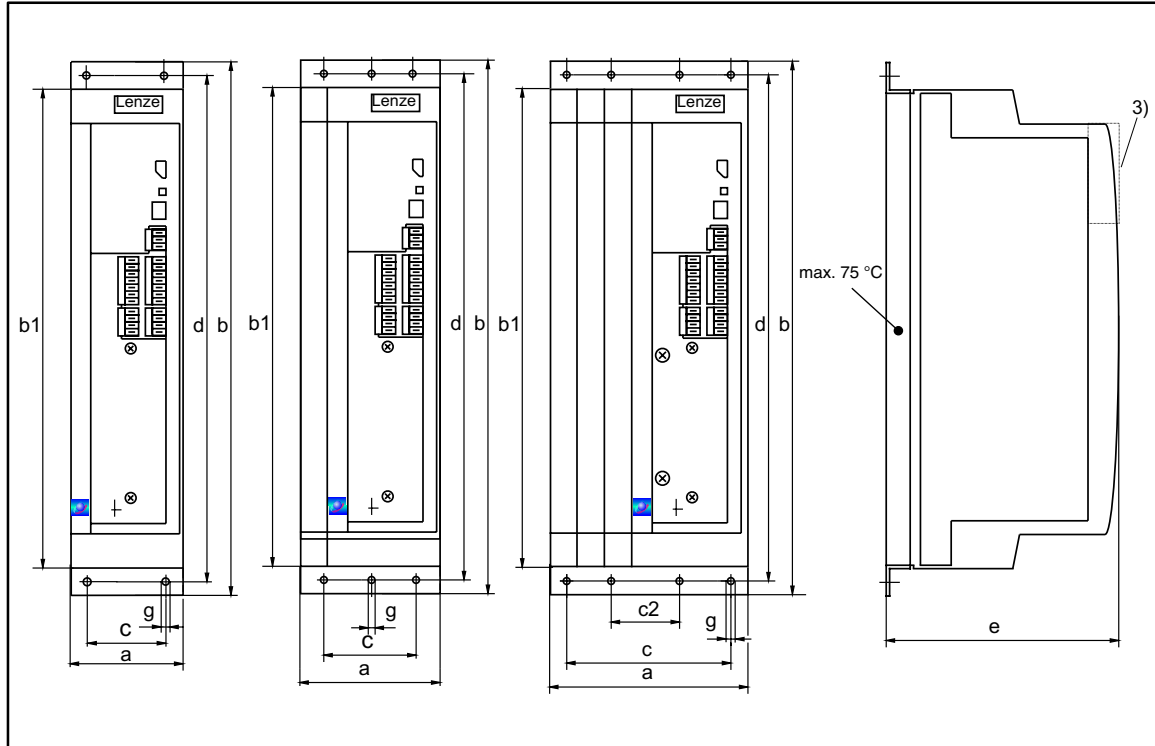
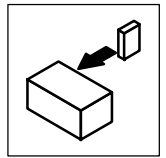

FIG 4-3 Dimensions 824X-C-V003: Control-cabinet assembly

³⁾ With attachable fieldbus or I/O module:
Observe assembly depth and required assembly space for connection cables

[mm]	a	b	b1	c	c2	d	e ³⁾	g
8241-V003 8242-V003	78	381	350	48	-	367	168	6.5
8243-V003 8244-V003	97	381	350	67	-	367	168	6.5
8245-V003 8246-V003	135	381	350	105	38	367	168	6.5



4.2 Electrical installation

4.2.1 Important notes

- For information on the installation according to EMC see chapter 4.3
- Prior to assembly and service operations, the personnel must be free of electrostatic charge.
- Unused control inputs and outputs should be covered with plugs.
- In case of condensation, connect the controller to the mains voltage only after the visible humidity has evaporated.
- Please observe the restrictions of each mains type!

Mains	Operation of the controllers	Notes
With grounded neutral (TT/TN mains)	No restrictions	Observe controller ratings.
With isolated neutral (IT mains)	Possible, if the controller is protected from an earth fault in the supplying mains <ul style="list-style-type: none"> • by corresponding equipment which detects the earth fault and • immediately separates the controller from the mains. 	Safe operation in the event of an earth fault in the output of the controller cannot be guaranteed.
With grounded phase	Operation is only possible with one variant.	Contact Lenze.
DC-supply via $+U_G/-U_G$	The DC voltage must be symmetrical to PE.	The controller will be destroyed when grounding $+U_G$ -conductor or $-U_G$ -conductor.

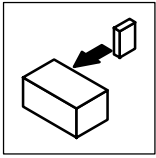

Installation

4.2.2 Power connections

4.2.2.1 Mains connection

Types 8221 to 8227	Types 8241 to 8246
<p>Correct screen connection with screened cables:</p> <ul style="list-style-type: none"> • Connect the screen with the conductive mounting plate using a suitable clamp. • To improve the screen connection: Connect screen additionally at the stud PE next to the power connections. 	<p>Connect screen correctly (required parts in the accessory kit):</p> <ul style="list-style-type: none"> • Screw screen sheet^① on the fixing bracket^②. • Fix screen using cable lugs. Do not use the screen for strain relief! • To improve the screen connection: Connect screen additionally at the stud PE next to the power connections.

FIG 4-4 Proposal for mains connection 822X/824X

- Connect the mains cables with the screw terminals L1, L2, L3.
- Tightening torques

Type	Terminals	
	L1, L2, L3, +UG, -UG	PE connection
8221 - 8223	4 Nm (35 lbin)	
8224 - 8225	7 Nm (62 lbin)	
8226 - 8227	12 Nm (106.2 lbin)	
8241 - 8246	0.5 ... 0.6 Nm (4.4 ... 5.3 lbin)	3.4 Nm (30 lbin)

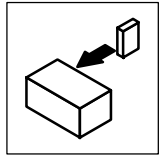

4.2.2.2 Motor connection

Because of the EMC safety we recommend the use of screened motor cables only.

<p>Types 8221/8222/8223</p>	<p>Correct screen connection with screened cables:</p> <ul style="list-style-type: none"> • Fix the screen of the motor cables and, if necessary, thermal contacts by means of butt joints. Do not use the screen for strain relief! • To improve the screen connection: Connect screens additionally at the stud PE next to the motor connections.
<p>Types 8224/8225</p>	<ul style="list-style-type: none"> • Strain relief by using cable binders ①. • Correct screen connection with screened cables: <ul style="list-style-type: none"> - Connect the screen of the motor cables to the screen sheet using a cable clamp and screws M5 x 12. ②. - Connect the screen of the thermal at the stud PE next to the motor connections with a surface as large as possible.
<p>Types 8226/8227</p>	<ul style="list-style-type: none"> • Strain relief by using cable clamps and screws M4 x 12. ③. - Additional strain relief/fixing can be achieved by using cable binders. ①. • Correct screen connection with screened cables: <ul style="list-style-type: none"> - Connect the screen of the motor cables to the screen sheet using a cable clamp and screws M5 x 12. ②. - Connect the screen of the thermal at the stud PE next to the motor connections with a surface as large as possible.

FIG 4-5 Proposal for the motor connection with 822X

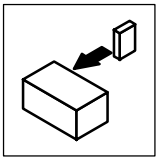

Installation

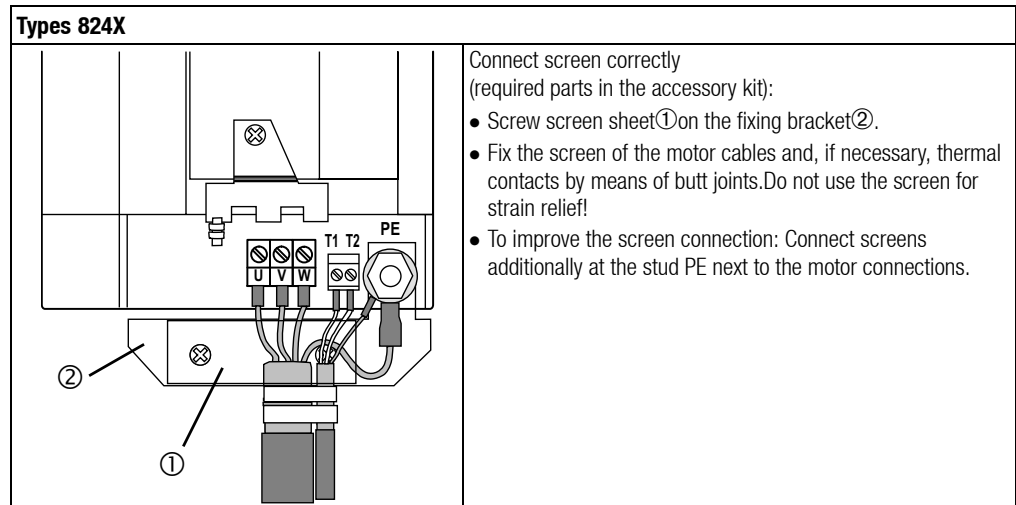
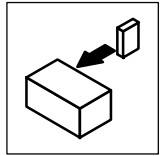

FIG 4-6 Proposal for the motor connection with 824X

- Connect the motor cables to the screw terminals U, V, W.
 - Observe correct pole connection.
 - Tightening torques

Type	Terminals			T1, T2
	U, V, W	PE connection	Screen/ strain relief	
8221 - 8223	4 Nm (35 lbin)		-	0.5 ... 0.6 Nm (4.4 ... 5.3 lbin)
8224 - 8225	7 Nm (62 lbin)		3.4 Nm (30 lbin)	
8226 - 8227	12 Nm (106.2 lbin)		M4: 1.7 Nm (15 lbin) M5: 3.4 Nm (30 lbin)	
8241 - 8246	0.5 ... 0.6 Nm (4.4 ... 5.3 lbin)	3.4 Nm (30 lbin)	-	

- Switching on the motor side of the controller is permitted
 - for safety switch off (emergency switch off).
 - during operation under load.



- The motor cable should be as short as possible because of the positive effect on the drive characteristic.
 - FIG 4-7 shows the relation between motor-cable length and the possible required output filters.
 - For group drives (several motors connected to one controller) it is necessary to calculate the resulting cable length l_{res} :

$$l_{res} = \text{Sum of all motor cable lengths} \cdot \sqrt{\text{No. of motor cables}}$$

- The conditions stated in FIG 4-7 are valid for chopper frequencies ≤ 8 kHz (C018 = -0-, -1-). When using controllers with chopper frequencies > 8 kHz, different measures may be required. Please contact Lenze.
- When using unscreened motor cables, the data indicated in FIG 4-7 are valid for the double motor-cable length.
- Please contact Lenze when the absolute or resulting motor-cable lengths are > 200 m.

Type	Output filters additionally required in the motor cable		
8221/8222	None	Motor filter/motor choke	Motor choke (Contact Lenze)
8223/8224/8225 8226/8227		None	
8241/8242/8243 8244/8245/8246	None	Motor filter/motor choke	Sine filter

0 50 100 200
 Motor-cable length (resulting), screened in m

FIG 4-7 Output filters additionally required in the motor cable

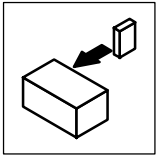

Installation

4.2.2.3 Connection diagram

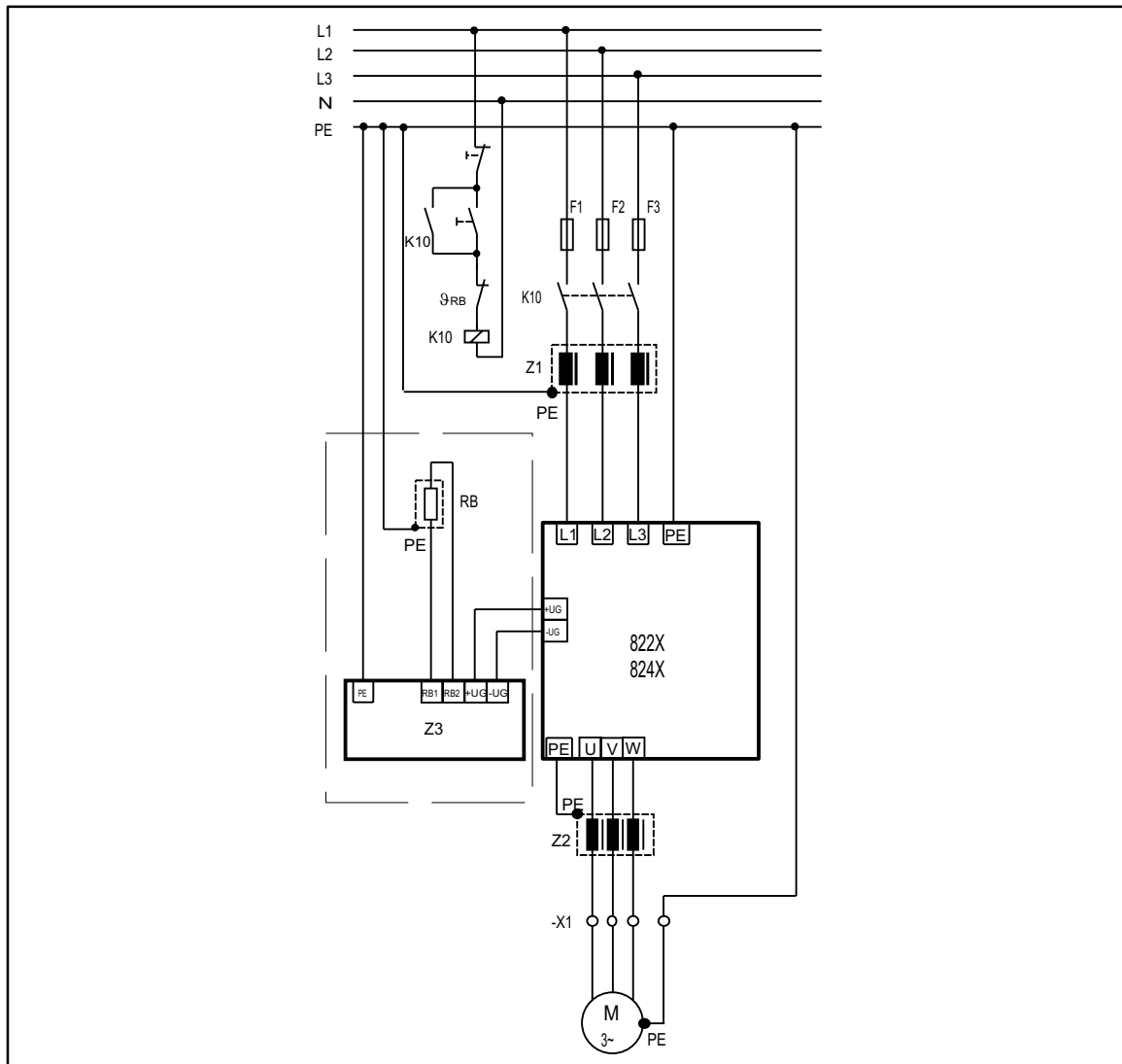
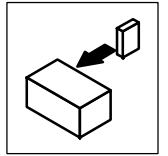

FIG 4-8 822X/824X power connections

- | | |
|------------|---|
| F1, F2, F3 | Fuses |
| K10 | Mains contactor |
| Z1 | Mains choke/mains filter, see Accessoires |
| | Types 8222-8227, 8244/8246 - operation only with assigned mains choke/mains filter |
| Z2 | Motor filter/sine filter, see Accessoires |
| Z3 | Brake chopper/brake module, see Accessoires |
| RB | Brake resistor, see Accessoires |
| 9RB | Temperature monitoring - brake resistor |
| X1 | Terminal strip in control cabinet |



4.2.3 Control connections

4.2.3.1 Control cables

- We recommend the unilateral screening of all cables for analog signals to avoid signal distortion.
- Connect the screens of the control cables as follows:

- 822X, 824X

With the collective screen sheet on the front metal surface (screw length max. 12 mm).

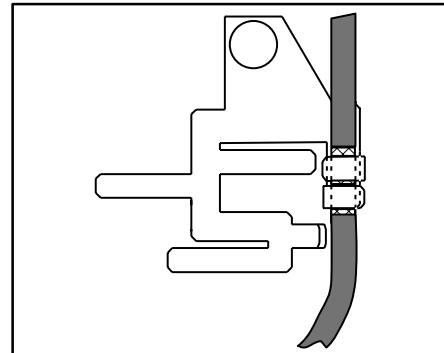

- If the control cables are interrupted (terminal strips, relays), the screens must be reconnected over the shortest possible distance.
- Connect the fixing screw of the setpoint potentiometer to PE.
- If possible, separate the monitoring cables from the motor cable.

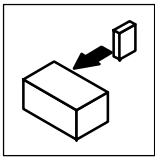

Installation

4.2.3.2 Assignment of the control terminals

	<p>Protection against contact The control terminals have a basic isolation (double insulating distance). The protection against contact is ensured without any additional measures.</p> <p>Protection against polarity reversal The protection against polarity reversal prevents the wrong connection of the internal control inputs. It is however possible to overcome the protection against polarity reversal by applying great force.</p> <p>Motor-temperature monitoring The connections of the motor-temperature monitoring (T1, T2) are next to the connection terminals U, V, W.</p>
--	---

FIG 4-9 Position of the control terminals

	Terminal	Use (Factory setting is printed in bold)	Level	Data
Analog inputs	7	GND 1		
	8	Setpoint input, reference: Terminal 7 (0 to 10V)	<p>Jumper</p>	5 - 6 0 to 20 mA 5 - 6 4 to 20 mA 3 - 4 0 to 5 V 1 - 2 0 to 10 V
	9	Supply for setpoint potentiometer	5.2V / 6mA	
Analog output	62	Analog output, reference: terminal 7 (Field frequency)	0... 6 V / 2 mA	Resolution: 10 bit
Digital inputs	20	Voltage supply for digital inputs 15 V/20 mA		
	28	Controller enable	HIGH	HIGH: 12 V ... 30 V
	E4	CW rotation/ CCW rotation (CW/CCW)	CW: LOW CCW: HIGH	LOW: 0 V ... 3 V
	E3	DC-injection brake	HIGH	
	E2	JOG frequencies	Binary code	
	E1	20Hz, 30Hz, 40Hz		
	39	GND 2 (reference for external voltages)		
Monitoring	T1	Motor-temperature monitoring (PTC thermistor/thermal contact)		If not used: set parameter C119 = -0-!
	T2	Motor-temperature monitoring (PTC thermistor/thermal contact)		

	Terminal	Use (Factory setting is printed in bold)	Relay position (switched)	Data
Relay output K1	K 11	Relay output normally-closed contact (TRIP)	opened	24 V AC / 3,0 A or 60 V DC / 0.5 A
	K 12	Relay mid-position contact		
	K 14	Relay output normally-open contact (TRIP)	closed	
Relay output K2	K 21	Relay output normally-closed contact (Ready for operation)	opened	250 V AC / 3,0A or 60 V DC / 0.5A
	K 22	Relay mid-position contact		
	K 24	Relay output normally-open contact (Ready for operation)	closed	

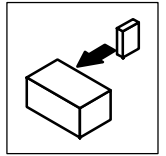

4.2.3.3 Connection diagrams

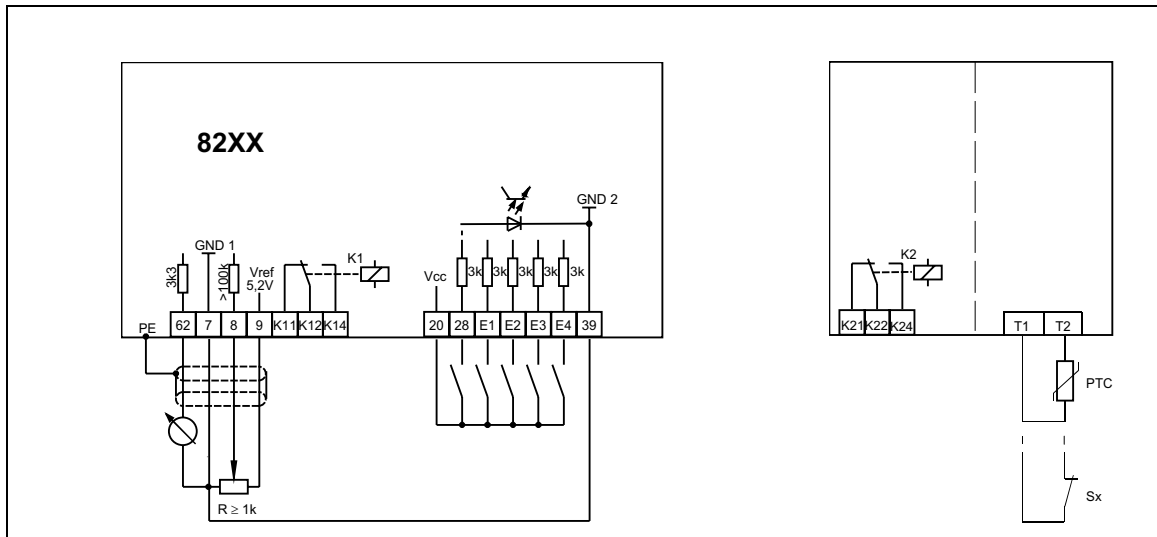

FIG 4-10 Control connections: Supply with internal control voltage

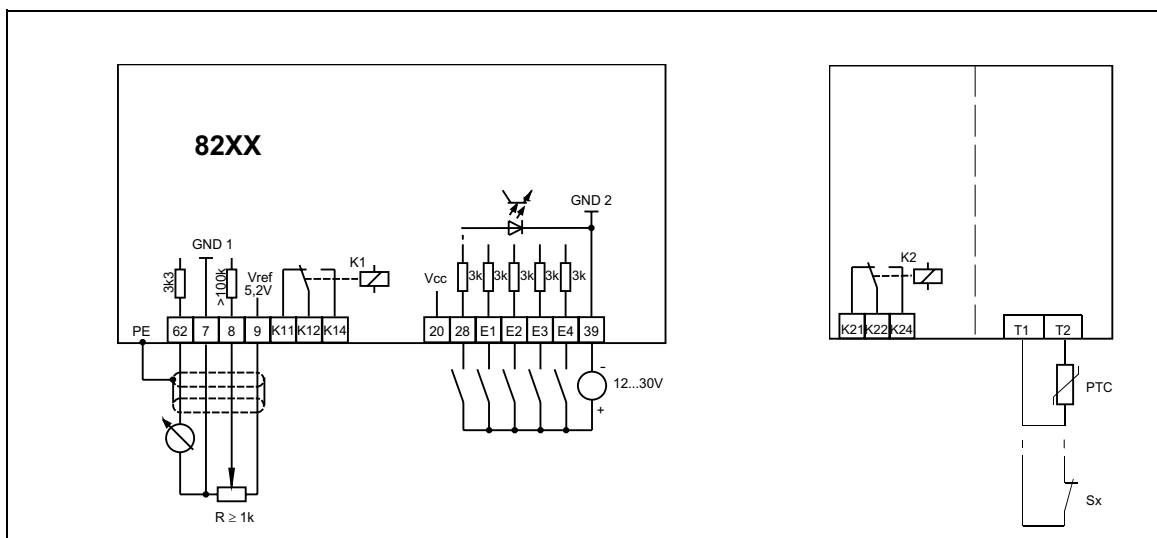
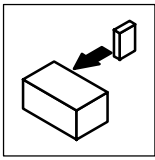

FIG 4-11 Control connections: Supply with external control voltage (+12 ... +30 V)

GND1 Reference for internal voltages

GND2 Reference for external voltages

GND1 and GND2 have a potential isolation inside the unit.



Installation

4.3 Installation of a CE-typical drive system

General notes	<ul style="list-style-type: none"> • The user is responsible for the compliance of his application with the EC directives. - If you observe the following measure you can be sure that the drive system will not cause any EMC problems, i.e. comply with the EMC Directive when running the machine. - If devices which do not comply with the CE requirement concerning noise immunity EN 50082-2 are operated close to the controller, these devices may be interfered electromagnetically by the controllers.
Assembly	<ul style="list-style-type: none"> • Connect controller, mains choke, and mains filter to the grounded mounting plate with a wire of large a cross-section as possible: <ul style="list-style-type: none"> - Mounting plates with conductive surfaces (zinc-coated, stainless steel) allow permanent contact. - Varnished boards should not be used for installation in accordance with EMC • If you use several mounting plates: <ul style="list-style-type: none"> - Connect as much surface as possible of the mounting plates (e.g. with copper bands). • Ensure the separation of motor cable and signal or mains cable. • Do not use the same terminal strip for mains input and motor output. • Cable guides as close as possible to the reference potential. Unguided cables have the same effect as aerials.
Filters	<ul style="list-style-type: none"> • Use mains filters or RFI filters and mains chokes which are assigned to the controller: <ul style="list-style-type: none"> - RFI filters reduce impermissible high-frequency interference to a permissible value. - Mains chokes reduce low-frequency interferences which depend on the motor cable and its length. - Mains filters combine the functions of mains choke and RFI filter.
Screening	<ul style="list-style-type: none"> • Connect the screen of the motor cable with the controller <ul style="list-style-type: none"> - to the screen connection of the controller. - additionally to the mounting plate with a surface as large as possible. - Recommendation: For the connection, use ground clamps on bare metal mounting surfaces. • If contactors, motor-protecting switches or terminals are located in the motor cable: <ul style="list-style-type: none"> - Connect the screens of the connected cables also to the mounting plate, with a surface as large as possible. • Connect the screen to PE, with a surface as large as possible. <ul style="list-style-type: none"> - Metal glands at the motor terminal box ensure a connection of the screen and the motor housing. • If the mains cable between mains filter and controller is longer than 300 mm: <ul style="list-style-type: none"> - Screen mains cables. - Connect the screen of the mains cable directly to the inverter and to the mains filter and connect it to the mounting plate with as large a surface as possible. • Use of a brake chopper: <ul style="list-style-type: none"> - Connect the screen of the brake resistor cable directly to the mounting plate, at the brake chopper and the brake resistor with as large a surface as possible. - Connect the screen of the cable between controller and brake chopper directly to the mounting plate, at the inverter and the brake chopper with a surface as large as possible. • Screen the control cables: <ul style="list-style-type: none"> - Connect both screen ends of the digital control cables. - Connect one screen end of the analog control cables. - Always connect the screens to the screen connection at the controller over the shortest possible distance. • Application of the controllers 821X/822X/824X in residential areas: <ul style="list-style-type: none"> - Use an additional screen damping ≥ 10 dB to limit the radio interference. This is usually achieved by installation in enclosed and grounded control cabinets made of metal.
Grounding	<ul style="list-style-type: none"> • Ground all metallically conductive components (controller, mains filter, motor filter, mains choke) using suitable cables connected to a central point (PE bar). • Maintain the minimum cross-sections prescribed in the safety regulations: <ul style="list-style-type: none"> - For EMC, not the cable cross-section is important, but the surface and the contact with a cross-section as large as possible, i.e. large surface.

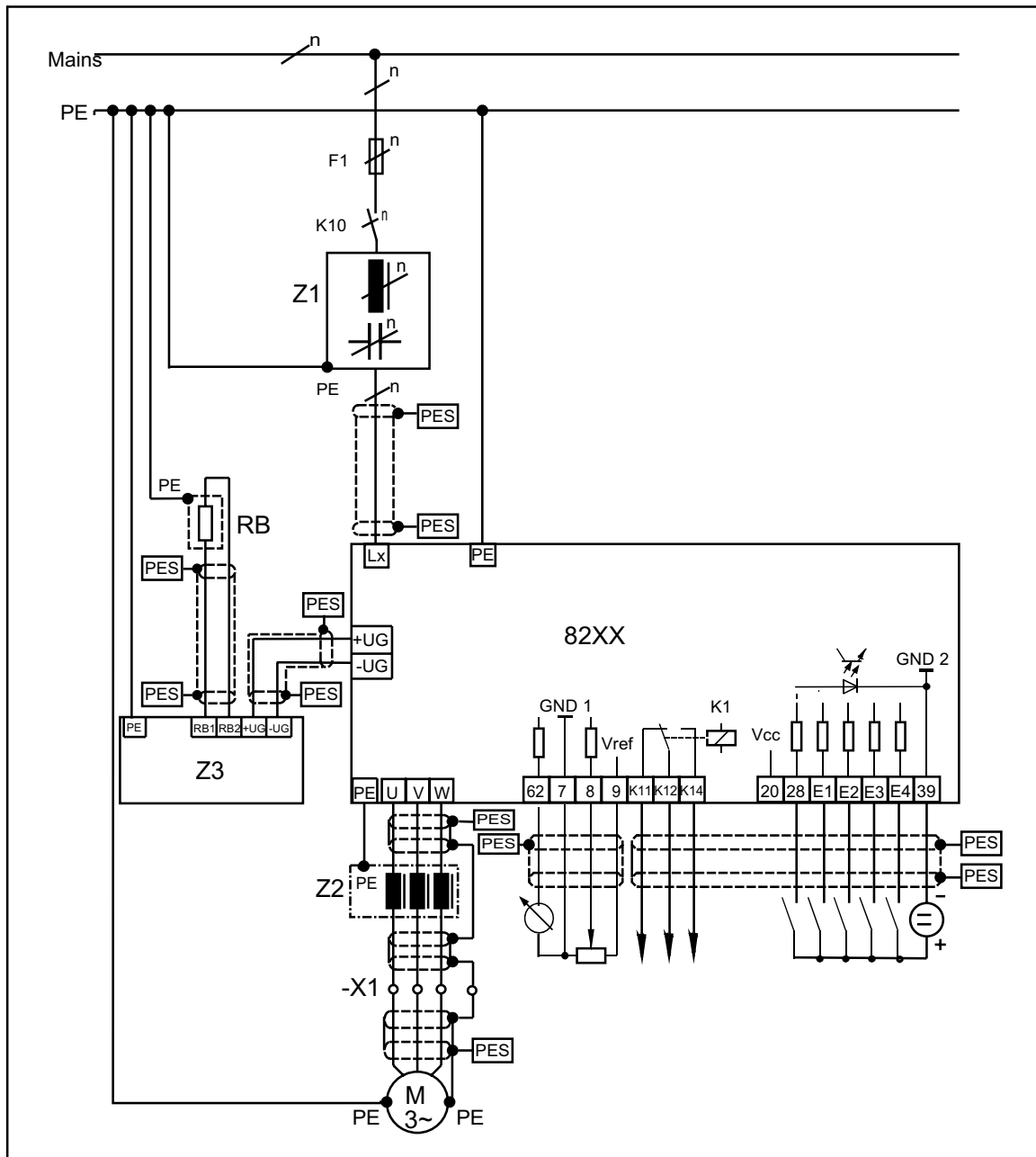
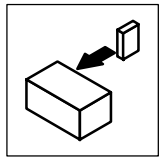
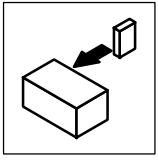
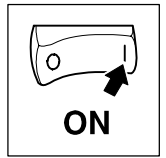

FIG 4-12 Example for an installation in accordance with the EMC regulations:

- | | |
|-----|--|
| F1 | Fuse |
| K10 | Mains contactor |
| Z1 | Mains filter "A" or "B", see Accessories |
| Z2 | Motor filter/sine filter, see Accessories |
| Z3 | Brake module/brake chopper, see Accessories |
| -X1 | Terminal strip in control cabinet |
| RB | Brake resistor |
| PES | HF screen because of a PE connection with a surface as large as possible (see "Screening" in this chapter) |
| n | Number of phases |



Installation



5 Commissioning

The controllers are factory-set to drive a corresponding four-pole standard asynchronous motor. Further settings are not necessary.

- 230/400 V, 50 Hz
- 265/460 V, 60 Hz
- 280/480 V, 60 Hz

Only a few settings via the 8201 BB operating module or a fieldbus module are necessary to adapt your drive to your application. The steps required are summarized in chapter 5.3 and chapter 5.4.

5.1 Before you switch on

Prior to initial switch-on of the controller, check the wiring for completeness, short-circuit, and earth fault:

- Power connection:
 - Via L1, L2 and L3 - 822X/824X
 - Alternatively via terminals +UG, -UG (DC-group drive)
- Control terminals:
 - Reference potential for the control terminals is terminal 39.
 - Controller enable: terminal 28
 - Selection of direction of rotation: terminal E3 or E4
 - External setpoint selection: terminals 7, 8
 - Check jumper position! Factory setting: 0 - 10 V (see page 4-12).
 - During operation with an internal voltage supply via terminal 20, bridge the terminals 7 and 39.
- In case of condensation connect the controller to mains voltage only after the visible humidity has evaporated.

Maintain the switch-on sequence!

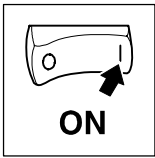

Commissioning

5.2 Short set-up with factory setting

5.2.1 Switch-on sequence

Step	
1. Switch on mains voltage	
2. Select the direction of rotation.	<ul style="list-style-type: none"> • CW rotation: - Apply a LOW signal to terminal E4 (0...+3V). • CCW rotation: - Apply a HIGH signal to terminal E4 (+12...+30V).
3. Select the setpoint.	Apply a voltage 0...+10 V to terminal 8.
4. Enable the controller.	Apply a HIGH signal (+12...+30V) to terminal 28.
5. The drive is now operating according to factory setting.	

5.2.2 Factory setting of the most important drive parameters

Setting	Code	Factory setting	Adaption to the application
Operating mode	C001	-0- Setpoint selection via terminal 8 Control via terminals Parameter setting via 8201BB	See the Code Table chapter 7.2
Terminal configuration	C007	-0- E4 E3 E2 E1 CW/CCW DC brake JOG1/2/3	See the Code Table chapter 7.2
Machine data			Chapter 5.3 ff.
Speed range	Min. field frequency	C010 0.0 Hz	See chapter 5.3.1
	Max. field frequency	C011 50.0 Hz	
Acceleration and deceleration times	Acceleration time	C012 5.0 s	See chapter 5.3.2
	Deceleration time	C013 5.0 s	
Current limit values	Motor mode	C022 150 %	See chapter 5.3.3
	Generator mode	C023 80 %	
Drive performance			Chapter 5.4 ff.
Current, torque, power characteristic	Operating mode	C014 -4- Motor-current control	Motor-current control, see chapter 5.4.2.1
	V/f rated frequency	C015 50.0 Hz	
	V _{min} setting	C016 0 %	V/f characteristic control, see chapter 5.4.2.2
	Slip compensation	C021 0 %	

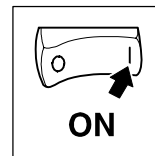

5.3 Adapt machine data

5.3.1 Determine speed range (f_{dmin} , f_{dmax})

Code	Name	Possible settings				IMPORTANT
		Lenze	Selection		Info	
C010	Minimum field frequency	0.0	0.0	{0.1Hz}	480.0	
C011	Maximum field frequency	50.0	7.5	{0.1Hz}	480.0	

Function

The speed range required for the application can be selected here by determining the field frequencies f_{dmin} and f_{dmax} :

- f_{dmin} corresponds to the speed at 0 % speed setpoint selection.
- f_{dmax} corresponds to the speed at 100 % speed setpoint selection.

Adjustment

Relation between field frequency and synchronous motor speed:

$$n_{rsyn} = \frac{f_{dmax} \cdot 60}{p}$$

n_{rsyn} synchronous motor speed [min^{-1}]
 f_{dmax} max. field frequency [Hz]
 p number of pole pairs

Example: 4 pole asynchronous motor:

$$p = 2, f_{dmax} = 50 \text{ Hz} \quad n_{rsyn} = \frac{50 \cdot 60}{2} = 1500 \text{ min}^{-1}$$

Important

- With the setting of $f_{dmin} > f_{dmax}$ the field frequency is limited to f_{dmax} .
- When selecting the setpoint by means of JOG values, f_{dmax} acts as limitation.
- f_{dmax} is an internal standardization variable:
 - Use the LECOM interface only for important modifications, when the controller is inhibited.
- Observe the maximum speed of the motor!
- f_{dmin} is only effective under the following conditions:
 - With analog setpoint selection.
 - With the motor potentiometer function "DOWN".

Special features

- With field frequencies $f_d > 300\text{Hz}$:
 - Avoid chopper frequencies $< 8 \text{ kHz}$.
- With C500 and C501, you can relate the display value of f_{dmin} and f_{dmax} to a process value.

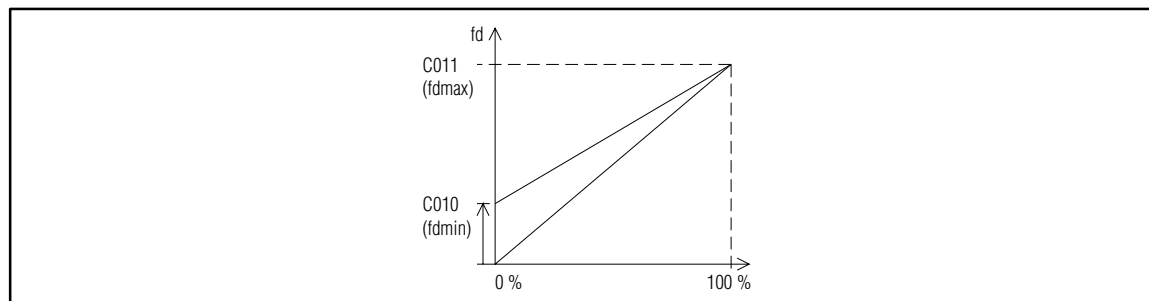

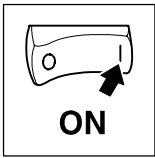

Commissioning

5.3.2 Adjustment of acceleration and deceleration times (T_{ir} , T_{if})

Code	Name	Possible settings			IMPORTANT
		Lenze	Selection	Info	
C012	Acceleration time	5.0	0.0 {0.1s}	999.0	T_{ir}
C013	Deceleration time	5.0	0.0 {0.1s}	999.0	T_{if}

Function

The acceleration and deceleration times determine the time required by the drive to follow a setpoint change.

Adjustment

- The acceleration and deceleration times refer to a change of the field frequency from 0 Hz to the max. field frequency set under C011.
- Calculate the times T_{ir} and T_{if} , which must be set under C012 and C013.
 - t_{ir} and t_{if} are the times required for the change between f_{d1} and f_{d2} :

$$T_{ir} = t_{ir} \cdot \frac{f_{dmax}}{f_{d2} - f_{d1}} \qquad T_{if} = t_{if} \cdot \frac{f_{dmax}}{f_{d2} - f_{d1}}$$

Important

Under unfavourable operating conditions, too short acceleration and deceleration times can lead to the deactivation of the controller under overload with the indication of TRIP OC5. In these events, the acceleration and deceleration times should be set short enough so that the drive can follow the speed profile without reaching I_{max} of the controller.

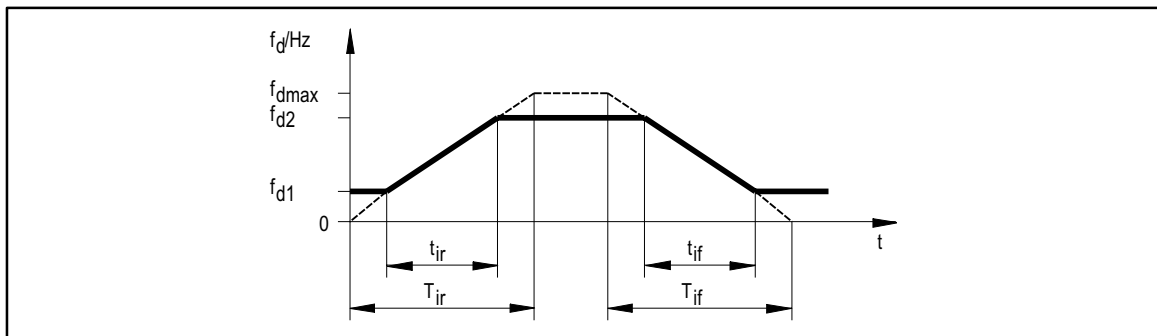

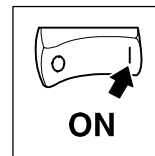

5.3.3 Setting of the current limit (I_{max})

Code	Name	Possible settings			IMPORTANT
		Lenze	Selection	Info	
C022	I_{max} limit motor mode	150	30 {1 %}	150	
C023	I_{max} limit generator mode	80	30 {1 %}	110	

Function The controllers are equipped with a current-limit control which determines the dynamic response under load. The measured load is compared with the limit values set under C022 for motor load and under C023 for generator load. If the current-limit values are exceeded, the controller will change its dynamic response.

Adjustment The acceleration and deceleration time should be set short enough so that the drive can follow the speed profile without reaching I_{max} of the controller.

Drive characteristic when reaching the limit value

- During acceleration:
 - Expansion of the acceleration ramp.
- During deceleration:
 - Expansion of the deceleration ramp.
- When the load increases at constant speed:
 - When the motor-current limit value is reached: Reduction of the field frequency to 0.
 - When the generator-current limit value is reached: Increase the field frequency to the maximum frequency (C011).
 - Stop the field-frequency change if the load falls below the limit value.

Important

- In the generator mode the current can only be controlled correctly when you connect a brake unit or in group drive with energy exchange.
- For operation with chopper frequencies > 8 kHz, the current limit values should be set to the currents " I_{max} for 60 s" indicated in the rated data (see chapter 3.2, derating with higher chopper frequencies) .

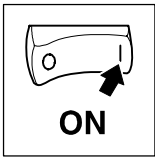

Commissioning

5.4 Optimize the operating characteristic of the drive

By means of the following settings you can influence the current, torque and power characteristic or the connected motor. You can choose between the control modes "motor-current control" and "V/f-characteristic control". In chapter 5.4.1 you will find some more information to help you with the selection.

5.4.1 Select the control mode

Code	Name	Possible settings			IMPORTANT
		Lenze	Selection	Info	
C014	Operating mode	-4-	-2- Linear characteristic $V \sim f_d$ with constant V_{min} boost -3- Square characteristic $V \sim f_d^2$ with constant V_{min} boost -4- Motor-current control	Control modes of the voltage characteristic	

Function

- Under C014 you can set the control mode and the voltage characteristic.
- The motor-current control enables a "Sensorless Speed Control". Compared with the V/f characteristic control, the drive can operate with a considerable higher torque and consumes less current during idle running.

C014 = -2-
Linear characteristic

C014 = -3-
Square-law characteristic (e. g. for pumps, fans)

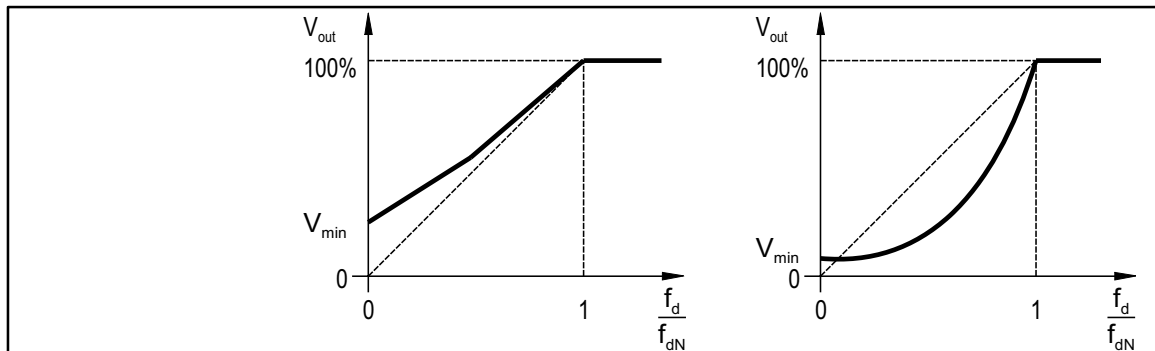

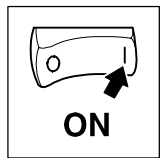

Help for decision	Motor cable			
	screened ≤ 50 m unscreened ≤ 100 m		screened > 50 m unscreened > 100 m	
	C014			
Single drives	recommended	alternatively	recommended	alternatively
with constant load	-4-	-2-	-2-	-
with changing loads	-4-	-2-	-2-	-
with heavy start conditions	-4-	-2-	-2-	-
Positioning and feed drives with high dynamic response	-2-	-	-2-	-
Hoists	-4-	-2-/-4-	-2-	-
Pumps and fan drives	-3-	-2-	-3-	-2-
Three phase reluctance motors	-2-	-	-2-	-
Three phase sliding-rotor motors	-2-	-	-2-	-
Three phase motors with assigned frequency-voltage characteristic	-2-	-	-2-	-
Group drives (depending on the resulting motor-cable length)	$I_{res} = \sqrt{I_1^2 + I_2^2 + \dots + I_n^2}$			
same motors and loads	-4-	-2-	-2-	-
different motors and/or changing loads	-2-	-	-2-	-

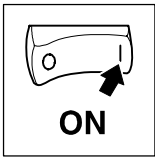

Commissioning

5.4.2 Optimize control modes

5.4.2.1 Optimize motor-current control

Codes required

Code	Name	Possible settings			IMPORTANT
		Lenze	Selection	Info	
C015	V/f-rated frequency	50.0	7.5 {0.1Hz} 960.0		
C021	Slip compensation	0	0 {1 %} 20		
C088	Rated motor current	*	0.0 ... 1.2 · rated output current	* depends on the unit	Input only necessary when motors not adapted.
C091	Motor cos φ	*	0.4 {0.1} 1.0		

Setting sequence

- Drives with matching 4 pole standard motors 230/400 V in star connection do not need to be adapted. After having started the drive, the controller itself detects all further motor data.
- The following drives can be optimized by entering the nameplate data "rated motor current" and "cos φ" under C088 or C091:
 - Motor one power class smaller than the motor assigned to the controller.
 - Motor one or two power classes smaller than the motor assigned to the controller.
 - Drives with 2, 6, 8, 10 and 12 pole standard motors.
 - Drives with special motors.
- With the slip compensation C021, you can optimize the "sensorless speed control" for your application.

1. If necessary, select C014 = (factory setting)
-4-

2. Select V/f-rated frequency (C015).

Motor voltage	Motor connection	C015
220/380 V	Y	52,6 Hz
230/400 V, 265/460 V, 280/480 V	Y	50 Hz
220/380 V, 230/400 V, 265/460 V, 280/480 V	Δ	87 Hz
380/660 V	Δ	52,6 Hz
400/690 V	Δ	50 Hz

3. If necessary, enter the motor data of unadapted motors (C088, C091).

4. Set slip compensation (C021):

Rough setting by means of the motor data:

$$s = \frac{n_{rsyn} - n_r}{n_{rsyn}} \cdot 100\%$$

$$n_{rsyn} = \frac{f_{dr} \cdot 60}{p}$$

- s Slip constant (C021)
- n_{rsyn} Synchronous motor speed [min^{-1}]
- n_r Rated speed to motor nameplate [min^{-1}]
- f_{dr} Rated frequency to motor nameplate [Hz]
- p Number of pole pairs

Precise setting:

Change C021 under constant load until the speed is near the synchronous speed. If C021 is set to too high values, the drive may become instable (overcompensation).

Important

- The change from V/f-characteristic control to motor-current control should only be carried out when the controller is inhibited.
- The idle current of the motor (magnetizing current) must not exceed the rated current of the controller.
- With very small friction values it is possible that an angle offset of up to 180° occurs when enabling the controller.

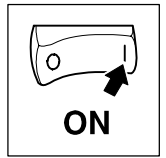

5.4.2.2 Optimize V/f-characteristic control

Codes required

Code	Name	Possible settings				IMPORTANT
		Lenze	Selection		Info	
C015	V/f-rated frequency	50.0	7.5	{0.1Hz}	960.0	
C016	V _{min} setting	0	0	{1 %}	40	
C021	Slip compensation	0	0	{1 %}	20	

Setting sequence

1. If necessary, select V/f characteristic (C014).

2. Select V/f-rated frequency (C015).

- The V/f-rated frequency determines the slope of the V/f characteristic and has considerable influence on the current, torque and power performance of the motor.
- An internal mains voltage compensation compensates deviations in the mains during operation. They therefore do not have to be considered for the setting of C015.

Adjustment

Calculate the frequency to be set under C015

$$C015 \text{ [Hz]} = \frac{400V}{U_{\text{rated motor}} \text{ [V]}} \cdot \text{Rated motor frequency [Hz]}$$

C014 = -2-
Linear characteristic

C014 = -3-
Square-law characteristic (e. g. for pumps, fans)

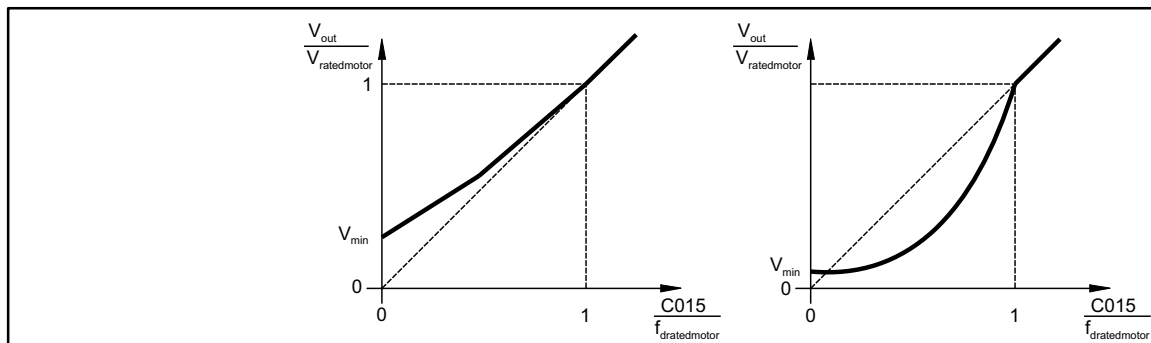

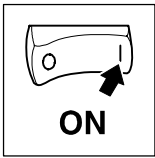

Commissioning

3. Set the V_{min} boost (C016).

- **Load-independent** boost of the motor voltage for field frequencies below the U/f-rated frequency. You can thus optimize the torque performance of the inverter drive.
- It is absolutely necessary to adapt the asynchronous motor used, since otherwise, the motor can be destroyed by overtemperature:

Adjustment

Please note the thermal characteristic of the connected motor under small field frequencies:

- Usually, standard asynchronous motors with insulation class B can be operated for a short time with rated current and frequencies between $0\text{Hz} \leq f_d \leq 25\text{Hz}$.
- Please ask the motor manufacturer for the exact setting values for the motor current.

A Operate the motor in idle running with a slip frequency of $f_d \approx$:

- P_{Mot} ≤ 7.5 kW: $f_d \approx 5\text{ Hz}$
- P_{mot} > 7.5 kW: $f_d \approx 2\text{ Hz}$

B Increase V_{min} until you reach the following motor current:

- **Motor in short-term operation** at $0\text{Hz} \leq f_d \leq 25\text{Hz}$:
with self-ventilated motors: $I_{\text{Motor}} \leq I_{\text{N motor}}$
with forced-ventilated motors: $I_{\text{motor}} \leq I_{\text{N motor}}$
- **Motor in permanent operation** at $0\text{Hz} \leq f_d \leq 25\text{Hz}$:
with self-ventilated motors $I_{\text{Motor}} \leq 0.8 \cdot I_{\text{N motor}}$
with forced-ventilated motors: $I_{\text{motor}} \leq I_{\text{N motor}}$

4. Set slip compensation (C021).

Rough setting by means of the motor data:

$$s = \frac{n_{\text{rsyn}} - n_r}{n_{\text{rsyn}}} \cdot 100\%$$

$$n_{\text{rsyn}} = \frac{f_{\text{dr}} \cdot 60}{p}$$

s	Slip constant (C021)
n_{rsyn}	synchronous motor speed [min^{-1}]
n_r	rated speed to motor nameplate [min^{-1}]
f_{dr}	rated frequency to motor nameplate [Hz]
p	Number of pole pairs

Precise setting:

Change C021 under constant load until the speed is near the synchronous speed.
If C021 is set to too high values, the drive may become instable (overcompensation).

Important

The change from V/f-characteristic control to motor-current control should only be made when the controller is inhibited.

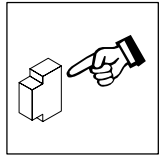

6 During operation

- Replace defective fuses with the prescribed type only when no voltage is applied.
There are no fuses in the controller.
- Cyclic mains switching:
 - Do not switch on the controller more than every 3 minutes, otherwise the internal initial-current limitation can be overloaded.
- Switching on the motor side:
 - Permissible for emergency switch-off.
 - Monitoring messages can be activated when switching the motor when the controller is enabled.
- Depending on the controller settings, the connected motor can be overheated:
 - For instance, longer DC-braking operations.
 - Longer operation of self-ventilated motors at low speed.
- The controllers generate an output frequency of up to 480 Hz when setting it correspondingly:
 - If an inappropriate motor is connected, a hazardous overspeed may occur.
- If you use the function CW/CCW (selection of the direction of rotation) with the configuration C007 = -0- to -13-:
 - The drive can reverse the direction of rotation in the event of a control-voltage failure or a cable break.
- If you use the function "Flying-restart circuit" (C142 = -2-, -3-) with machines with low inertia torque and friction:
 - The motor can start for a short time or reverse the direction of rotation for a short time after enabling the controller when the motor is in standstill.
- The controllers 822X/824X have a temperature-dependent fan circuit:
 - The fans are only activated when the heat sink temperature, which is a fixed factory setting, is exceeded.

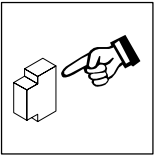

During operation

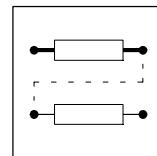

7 Configuration

7.1 Basics

- The configuration of the controller is used to adapt the drive to your applications.
- For this, you have the following functions available:
 - Operating functions
 - Control function
 - Display functions
 - Monitoring functions
- The possible function settings are organized in codes:
 - Codes are numerically sorted, starting from the code with the smallest number to the one with the highest number. All codes start with a "C".
 - They are listed in the code table.
 - Each code provides parameters which can be used to adjust and optimize your drive.
- The configuration of the controller can be entered by means of the keypad of the 8201BB operating module or by means of a fieldbus via the serial interface.
 - The operating module and fieldbus modules are available as accessories.
- The changing of parameters by means of the operating module or fieldbus modules is described
 - in the Operating Instructions of the modules.
 - in the Manual.
- All functions of the controller are described shortly in the code table. A detailed description can be obtained from the Manual.

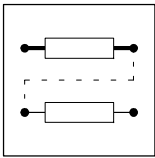

Configuration

7.2 Code table

How to read the code table:

Column	Abbreviation	Meaning
Code	C013	Code C013 <ul style="list-style-type: none"> The parameter of the code can be different in PAR1 and PAR2. The parameter value is accepted immediately (ONLINE).
	C009*	<ul style="list-style-type: none"> The parameter value of the code is always the same in PAR1 and PAR2, but is always displayed in PAR1.
	C001 ↵	<ul style="list-style-type: none"> The parameter value of the code will be accepted after pressing SH+PRG.
	[C002]	<ul style="list-style-type: none"> The parameter value of the code will be accepted after pressing SH+PRG but only if the controller is inhibited.
Name	820X	Name of the code. Unit-specific setting possibilities (here for 820X). Without unit designation the code is valid for all unit types.
Lenze		Factory setting of the code
	*	The column "Important" contains further information
Selection	1 {1 %} 99	Minimum value {smallest step/unit} maximum value
Info	-	Meaning of the code
IMPORTANT	-	Additional, important explanations of the code

Code	Name	Possible settings			IMPORTANT
		Lenze	Selection	Info	
C001 ↵	Operating mode	-0-	-0- Setpoint selection via term. 8 Control via terminals Parameter setting via 8201BB -1- Setpoint selection via 8201BB or via LECOM Control via terminals Parameter setting via 8201BB -2- Setpoint selection via term. 8 Control via terminals Parameter setting via LECOM -3- Setpoint selection via LECOM Control via LECOM Parameter setting via LECOM		
[C002]*	Parameter set		-0- Function executed -1- Overwrite PAR1 with factory setting -2- Overwrite PAR2 with factory setting -3- Overwrite PAR1 and PAR2 with the data of the operating module -4- Overwrite PAR1 with the data of the operating module -5- Overwrite PAR2 with the data of the operating module -6- Transmit PAR1 and PAR2 to the operating module		
C004 ↵	Switch-on display	-0-	-0- Field frequency f_d -1- Controller load -2- Motor current		

Configuration

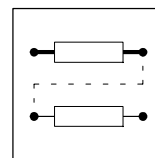

Code	Name	Possible settings				IMPORTANT	
		Lenze	Selection				Info
[C007]*	Terminal configuration	-0-	E4	E3	E2	E1	<ul style="list-style-type: none"> • CW = CW rotation • CCW = CCW rotation • DC brake = DC injection brake • PAR = Change of parameter sets • JOG = JOG frequency • QSP = Quick stop • Trip-Set = External fault • UP/DOWN = Motor potentiometer functions
			-0-	CW/CCW	DC brake	JOG1/2/3	
			-1-	CW/CCW	PAR	JOG1/2/3	
			-2-	CW/CCW	QSP	JOG1/2/3	
			-3-	CW/CCW	PAR	DC brake JOG1	
			-4-	CW/CCW	QSP	PAR JOG1	
			-5-	CW/CCW	DC brake	Trip set JOG1	
			-6-	CW/CCW	PAR	Trip set JOG1	
			-7-	CW/CCW	PAR	DC brake Trip set	
			-8-	CW/CCW	QSP	PAR Trip set	
			-9-	CW/CCW	QSP	Trip set JOG1	
			-10-	CW/CCW	Trip set	UP DOWN	
			-11-	CW/CCW	DC brake	UP DOWN	
			-12-	CW/CCW	PAR	UP DOWN	
			-13-	CW/CCW	QSP	UP DOWN	
			-14-	CCW/QSP	CW/QSP	DC brake JOG1	
			-15-	CCW/QSP	CW/QSP	PAR JOG1	
			-16-	CCW/QSP	CW/QSP	JOG1/2/3	
			-17-	CCW/QSP	CW/QSP	PAR DC brake	
			-18-	CCW/QSP	CW/QSP	PAR Trip set	
			-19-	CCW/QSP	CW/QSP	DC brake Trip set	
			-20-	CCW/QSP	CW/QSP	Trip set JOG1	
			-21-	CCW/QSP	CW/QSP	UP DOWN	
			-22-	CCW/QSP	CW/QSP	UP JOG1	
C008	Function relay K1	-1-	-0-	Ready for operation			
			-1-	TRIP fault message			
			-2-	Motor is running			
			-3-	Motor is running / CW rotation			
			-4-	Motor is running / CCW rotation			
			-5-	Field frequency $f_d=0$			
			-6-	f_{dset} reached			
			-7-	Q_{min} reached			
			-8-	I_{max} reached			
			-9-	Overtemperature ($\vartheta_{max} -10\text{ }^\circ\text{C}$)			
			-10-	TRIP or Q_{min} or IMP			
C009*	Device address	1	1	{1}	99		Only for LECOM applications
C010	Minimum field frequency	0.0	0.0	{0.1Hz}	480.0		
C011	Maximum field frequency						
		820X	50.0	30.0	{0.1Hz}	480.0	
		821X	50.0	7.5	{0.1Hz}	480.0	(Software 2x)
				30.0	{0.1Hz}	480.0	(Software 1x)
822X/824X	50.0	7.5	{0.1Hz}	480.0			
C012	Acceleration time	5.0	0.0	{0.1s}	999.0		
C013	Deceleration time	5.0	0.0	{0.1s}	999.0		

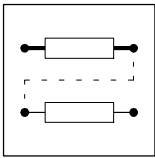

Configuration

Code	Name	Possible settings				IMPORTANT	
		Lenze	Selection	Info			
C014	Operating mode	820X	-0-	-0-	Linear characteristic $V \sim f_d$ with auto boost		
			-1-	-1-	Square characteristic $V \sim f_d^2$ with auto boost		
		821X/822X/824X	-2-	-2-	Linear characteristic $V \sim f_d$ with constant V_{min} boost		
			-3-	-3-	Square characteristic $V \sim f_d^2$ with constant V_{min} boost		
		-4-	-4-	Motor-current control			
C015	V/f-rated frequency	820X	50.0	30.0	{0.1Hz} 960.0		
		821X	50.0	7.5	{0.1Hz} 960.0		(Software 2x)
				30.0	{0.1Hz} 960.0		(Software 1x)
		822X/824X	50.0	7.5	{0.1Hz} 960.0		
C016	V_{min} setting	820X	*	0	{1 %} 40	* depends on the unit	
		821X/822X/824X	0	0	{1 %} 40		
C017	Threshold Q_{min}	0.0	0.0	{0.1Hz} 480.0			
C018	Chopper frequency 821X/822X/824X	-1-	-0-	4 kHz			
			-1-	8 kHz			
			-2-	12 kHz			
			-3-	16 kHz			
			-4-	12 kHz noise optimized			
			-5-	16 kHz noise optimized			
C019	Threshold auto DC brake 821X/822X/824X	0.1	0.1	{0.1Hz} 5.0			
C021	Slip compensation	820X	0	0	{1 %} 12		
		821X	0	0	{1 %} 20		(Software 2x)
				0	{1 %} 12		(Software 1x)
		822X/824X	0	0	{1 %} 20		
C022	I_{max} limit motor mode	150	30	{1 %} 150			
C023	I_{max} limit generator mode	80	30	{1 %} 110			
C034	Master current	-0-	-0-	0 to 20mA / 0 to 5V / 0 to 10V			
			-1-	4 to 20mA			
C036	Voltage for DC brake	*	0	{1 %} 40	* depends on the unit		
C037	JOG value 1	20	0	{1Hz} 480			
C038	JOG value 2	30	0	{1Hz} 480			
C039	JOG value 3	40	0	{1Hz} 480			
C050*	Output frequency				Only display		
C052*	Motor voltage				Only display		
C054*	Motor current				Only display		

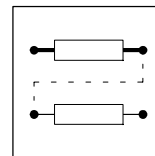

Code	Name	Possible settings			IMPORTANT
		Lenze	Selection	Info	
C056*	Controller load				Only display
C061*	Heat sink temperature				Only display
C079	Oscillation damping				Is not transferred when transferring parameters via the operating module.
		822X/824X	5	0 {1} 80	
C088	Rated motor current 821X/822X/824X	*	0.0 ... 1.2 · rated output current		* depends on the unit
C091	Motor cos φ 821X/822X/824X	*	0.4 {0.1}	1.0	* depends on the unit
C093*	Type				Only display
		820X		820X	
		821X		821X	
		822X/824X		822X	
C099*	Software version				Only display
		820X		82 1x (Software 1x)	
		821X		82 2x (Software 2x) 82 1x (Software 1x)	
		822X/824X		82 1x (Software 1x)	
C105	Deceleration time quick stop 821X/822X/824X	5.00	0.00 {0.01s}	999.00	
C106	Holding time for autom. DC injection brake				
		820X	0.00	0.00 {0.01s} 50.00	
		821X/822X 824X	0.02	0.00 {0.01s} 999.00	
C108*	Gain (C111)				
		820X	220	0 {1} 255	
		821X	128	0 {1} 255	
		822X/824X	128	0 {1} 255	
C111 ↓	Monitor signal	-0-	-0- Field frequency -1- Controller load -2- Motor current -3- DC-bus voltage		
C117 ↓	Function relay K2 822X/824X	-0-	-0- Ready for operation -1- TRIP fault message -2- Motor is running -3- Motor is running / CW rotation -4- Motor is running / CCW rotation -5- Field frequency $f_{d}= 0$ -6- f_{dSet} reached -7- Q_{min} reached -8- I_{max} reached -9- Overtemperature ($\vartheta_{max} -10^{\circ}C$) -10- TRIP or Q_{min} or IMP -11- PTC warning		

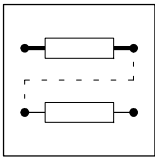

Configuration

Code	Name	Possible settings			IMPORTANT
		Lenze	Selection	Info	
C119 _J	Function PTC 822X/824X	-0-	-0- PTC input inactive -1- PTC input active, TRIP and IMP (pulse inhibit) are set -2- PTC input active, warning		
C120	$I^2 \cdot t$ switch off 822X/824X	0	0 {1 %} 100		
C125 _J *	LECOM baud rate	-0-	-0- 9600 baud -1- 4800 baud -2- 2400 baud -3- 1200 baud -4- 19200 baud		Only for LECOM applications
C142 _J	Start condition	-1-	-0- Automatic start inhibited, flying-restart circuit inactive -1- Automatic start, if term. 28 HIGH, flying-restart circuit not active -2- Automatic start inhibited, flying-restart circuit active -3- Automatic start, if term. 28 HIGH, flying-restart circuit active		
C144 _J	Chopper-frequency reduction 821X/822X/824X	-1-	-0- No chopper-frequency reduction -1- Automatic chopper-frequency lowering when $\vartheta_{max} - 10 \text{ }^\circ\text{C}$		
C161*	Current fault				Only display
C162*	Last fault				Only display
C163*	Last but one fault				Only display
C164*	Last but two fault				Only display
C170 _J	TRIP-reset selection		-0- TRIP-reset by pressing the STP key or LOW signal at ctrl. enable -1- Auto-TRIP-Reset		
C171	Delay for Auto-TRIP-Reset	0	0 {1s} 60		
C178*	Operating time				Only display
C179*	Mains switch-on time				Only display
C377	Gain Zk-voltage detection 822X/824X				Should only be changed by the Lenze Service!
C500*	Display factor application datum numerator 821X/822X/824X	2000	1 {1} 25000		
C501*	Display factor for process variable denominator 821X/822X/824X	10	1 {1} 25000		



8 Troubleshooting and fault elimination

- You can recognize immediately whether a fault has occurred by display elements or status information (chapter 8.1).
- The fault can be analysed by using the history buffer (chapter 8.2) and the list in chapter 8.3. The list helps you with the elimination of faults.

8.1 Troubleshooting

8.1.1 Display at the controller

During operation without an operating module, the operating state of the controller is displayed on two LEDs at the front of the unit.

LED		Operating status
green	red	
on	off	Controller enabled
on	on	Mains switched on and automatic start inhibited (AS_LC)
blinking	off	Controller inhibited
off	blinking every second	Fault message, check under C161
off	blinking every 0.4 seconds	Undervoltage switch-off
off	off	Programming mode

8.1.2 Display at the operating module

Status indications in the display indicate the controller status.

Display	Meaning
OV	Overvoltage
UV	Undervoltage
IMAX	Set current limit exceeded
TEMP	Heat sink temperature near switch-off



Troubleshooting and fault elimination

8.1.3 Maloperation of the drive

Maloperation	Possible causes
Motor does not rotate	<ul style="list-style-type: none"> • DC-bus voltage too low (red LED is blinking every 0.4 s; message LU is displayed) • Controller inhibited (green LED is blinking, display of the operating module: OFF, STOP or AS_LC) • Setpoint = 0 • DC braking active • Quick-stop function active • JOG setpoint activated and JOG frequency = 0 • Fault is indicated (see chapter 8.3) • Mechanical motor brake is not released
Motor does not rotate smoothly	<ul style="list-style-type: none"> • Defective motor cable • Maximum current C022 and C023 too low • Motor underexcited or overexcited (check parameter setting)
Current consumption of motor too high	<ul style="list-style-type: none"> • Setting of C016 too high • Setting of C015 too low • C088 and C091 are not adapted to the motor data.

8.2 Fault analysis using the history buffer

- The history buffer is used to trace faults. The fault messages are stored in the history buffer in the order of their occurrence.
- The history buffer has 4 memory locations which can be addressed via codes.

Structure of the history buffer

Code	C0168	Entry	Note
C161	Memory locations 1	Active fault	If the fault is no longer active or has been acknowledged: <ul style="list-style-type: none"> • The contents of the memory locations 1-3 will be saved in a "higher" location. • The contents of the memory location 4 will be eliminated from the history buffer and cannot be read any longer. • Memory location 1 will be deleted (= no active fault).
C162	Memory location 2	Last fault	
C163	Memory location 3	Last but one fault	
C164	Memory location 4	Last but two fault	



8.3 Fault indications

Display	Fault	Cause	Remedy
---	No fault	-	-
EEr	External fault (TRIP-Set)	A digital input assigned to the TRIP-Set function has been activated	Check external encoder
H05	Internal fault		Contact Lenze
LU	Undervoltage	DC-bus voltage too low	<ul style="list-style-type: none"> • Check mains voltage • Check supply module
OC1	Short circuit	Short circuit	Find out cause of short circuit; check cable
		Excessive capacitive charging current of the motor cable	Use motor cable which is shorter or of lower capacitance
OC2	Earth fault	Grounded motor phase	Check motor; check cable
		Excessive capacitive charging current of the motor cable	Use motor cable which is shorter or of lower capacitance
OC3	Overload inverter during acceleration or short circuit	Acceleration time too short (C012)	<ul style="list-style-type: none"> • Increase acceleration time • Check drive selection
		Defective motor cable	Check wiring
		Interturn fault in the motor	Check motor
OC4	Overload controller during deceleration	Deceleration time too short (C013)	<ul style="list-style-type: none"> • Increase deceleration time • Check the selection of the brake resistor or connect the brake chopper
OC5	I x t overload	Frequent and too long acceleration processes with overcurrent	Check drive dimensioning
		Permanent overload with $I_{\text{motor}} > 1.05 \times I_{N\text{x}}$	
OC6	Overload motor	Motor is thermally overloaded, for instance, because of <ul style="list-style-type: none"> • impermissible continuous current • frequent or too long acceleration processes 	<ul style="list-style-type: none"> • Check drive selection • Check the setting under C120
OH	Heat sink temperature is higher than the value set in the controller	Ambient temperature $T_{\text{amb}} > +40 \text{ °C}$ or $+50 \text{ °C}$	<ul style="list-style-type: none"> • Allow controller to cool and ensure ventilation • Check the ambient temperature in the control cabinet
		Heat sink very dirty	Clean heat sink
		Incorrect mounting position	Change mounting position
OH3	PTC monitoring (TRIP)	Motor too hot because of excessive current or frequent and too long acceleration	Check drive dimensioning
		PTC not connected	Connect PTC or switch off monitoring (C0585=3)
OH4	Overtemperature unit	Inside unit too hot	<ul style="list-style-type: none"> • Reduce controller load • Improve cooling • Check fan in the controller
OH51	PTC monitoring (Warning)	Motor too hot because of excessive current or frequent and too long acceleration	Check drive selection
		PTC not connected	Connect PTC or switch off monitoring



Troubleshooting and fault elimination

Display	Fault	Cause	Remedy
OV	Overvoltage	Mains voltage too high	Check voltage supply
		Feedback operation Braking operation	<ul style="list-style-type: none"> • Increase deceleration times. • For operation with brake choppers: <ul style="list-style-type: none"> - Check the selection and connection of the brake resistor - Increase the deceleration times
		Earth leakage on the motor side	Check motor cable and motor for earth fault (disconnect motor from inverter)
rSt	Faulty auto-TRIP reset	More than 8 fault messages in 10 minutes	Depends on the fault message
Pr	Faulty parameter transfer via the operating module	PAR1 and PAR2 are defective.	It is absolutely necessary to repeat the data transfer or load the factory setting before enabling the controller.
Pr1	Faulty PAR1 transfer via the operating module	PAR1 is defective.	
Pr2	Faulty PAR2 transfer via the operating module	PAR2 is defective.	



8.4 Reset of fault indications

TRIP

After eliminating the fault, the pulse inhibit will only be reset after the acknowledgement of TRIP.



Note!

If the TRIP source is still active, the TRIP cannot be reset.

Code	Name	Possible settings			IMPORTANT
		Lenze	Selection	Info	
C170	TRIP-reset selection		-0- TRIP-reset by pressing the STP key or a LOW signal at ctrl. enable -1- Auto-TRIP reset		
C171	Deceleration for Auto-TRIP reset	0	0 {1s}	60	

Function

You can select whether the active fault is to be reset automatically or manually. Auto-Trip reset does not reset all faults automatically.

Activation

C170 = -0-:

- Manual TRIP-reset
- STP key
- LOW signal at terminal 28

C170 = -1-:

Auto-Trip reset resets the following fault messages after the time set under C171:

- OC3 (overload during acceleration)
- OC4 (overload during deceleration)
- OC5 (overload)
- OC6 (I · t switch-off)
- OH (overtemperature)
- OUE (overvoltage in DC bus)

Important

Mains switching always resets TRIP.
With more than 8 auto-trip resets within 10 minutes, the controller sets TRIP and indicates rST (numerator exceeded).



Troubleshooting and fault elimination

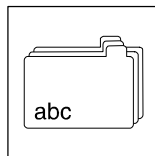

9 Accessories (Survey)

A detailed description of the accessories and Lenze three-phase a.c. motors can be found in the corresponding product catalogs.

9.1 Accessories for all types

Name	Order number
8201BB operating module	EMZ8201BB
Diagnosis terminal (2.5 m cable)	EMZ8272BB-V001
Diagnosis terminal (5.0 m cable)	EMZ8272BB-V002
Diagnosis terminal (10 m cable)	EMZ8272BB-V003
Digital display	EPD203
Setpoint potentiometer	ERPD0001k0001W
Rotary button for potentiometer	ERZ0001
Scale for potentiometer	ERZ0002
RS232/485 fieldbus module	EMF2102IB-V001
RS485 fieldbus module	EMF2102IB-V002
Level converter for RS485	EMF2101IB
PC system cable RS232/485	EWL0020
Optical fibre fieldbus module	EMF2102IB-V003
Optical fibre adaptor for PLC 0...40m	EMF2125IB
Supply unit for optical fibre adaptor 2125	EJ0013
InterBus-S module	EMF2111IB
PROFIBUS module	EMF2131IB
System bus module (CAN)	EMF2171IB
System bus module (CAN) with addressing	EMF2172IB
PTC module	EMZ8274IB
I/O module	EMZ8275IB
Monitor module	EMZ8276IB
Bipolar setpoint module	EMZ8278IB

9.2 Software

Name	Order number
PC program for Global Drive controllers	ESP-GDC 1

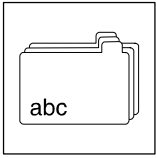

Accessories

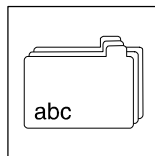

9.3.3 Types 8241 - 8244

Name	Order number			
	8241	8242	8243	8244
E.l.c.b.	EFA3B06A	EFA3B06A	EFA3B10A	EFA3B10A
Fuse	EFSM-0060AWE	EFSM-0060AWE	EFSM-0100AWE	EFSM-0100AWE
Fuse holder	EFH10001	EFH10001	EFH10001	EFH10001
Mains filter type A	EZN3A2400H002	EZN3A1500H003	EZN3A0900H004	EZN3A0500H007
Mains filter type B	EZN3B2400H002	EZN3B1500H003	EZN3B0900H004	EZN3B0500H007
Motor filter	ELM3-030H004	ELM3-030H004	ELM3-014H010	ELM3-014H010
Sine filter	EZS3-002A001	EZS3-004A001	EZS3-006A001	EZS3-010A001
Brake module	EMB9351-E	EMB9351-E	EMB9351-E	EMB9351-E
Brake chopper	EMB9352-E	EMB9352-E	EMB9352-E	EMB9352-E
Brake resistor	ERBD180R300W	ERBD180R300W	ERBD082R600W	ERBD068R800W
Thermal separation ("Push-through technique")	EJ0036	EJ0036	EJ0037	EJ0037
DC-bus fuse	EFSCC0060AYJ	EFSCC0060AYJ	EFSCC0080AYJ	EFSCC0120AYJ
Fuse holder	EFH20004	EFH20004	EFH20004	EFH20004

9.3.4 Types 8245 - 8246

Name	Order number	
	8245	8246
E.l.c.b.	EFA3B13A	EFA3B20A
Fuse	EFSM-0160AWE	EFSM-0200AWE
Fuse holder	EFH10001	EFH10001
Mains filter type A	EZN3A0300H013	EZN3B0300H013
Mains filter type B	EZN3B0300H013	ELN3-0160H012
Motor filter	ELM3-014H010	EZN3A0150H024
Sine filter	EZS3-009A002	EZN3B0150H024
Brake module	EMB9351-E	EMB9351-E
Brake chopper	EMB9352-E	EMB9352-E
Brake resistor	ERBD047R01k2	ERBD047R01k2
Thermal separation ("Push-through technique")	EJ0038	EJ0038
DC-bus fuse	EFSCC0200AYJ	EFSCC0400AYJ
Fuse holder	EFH20004	EFH20004

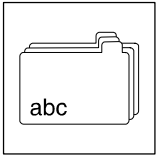

Accessories

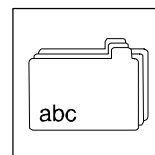

10 Index

A

- Acceleration times, 5-4
- Adapt the motor, 5-6
- Application, as directed, 1-2
- Application conditions, 2-1
- Applications as directed, 1-2
- Approvals, 2-1
- Assembly
 - Cold-plate technique
 - Preparations, 4-3
 - Typen 822X, 4-3
 - Types 824X, 4-4
 - With fixing brackets
 - Types 822X, 4-2
 - Types 824X, 4-2
- Auto-TRIP reset, 8-5

C

- Cable cross-sections, Single drives, 3-7
 - 120 % overload, 3-8
 - 150 % overload, 3-7
- Code table, 7-2
 - Information on the, 7-2
- Cold plate, Variant, 4-3
- Commissioning, 5-1
- Configuration, 7-1
 - Acceleration and deceleration times, 5-4
 - Basic information, 7-1
 - Code table, 7-2
 - Current limit value, 5-5
 - Maximum field frequency, 5-3
 - Minimum field frequency, 5-3
- Connecti, Leistungs-, Schaltplan, 4-10
- Connection
 - Control, Connection diagram, 4-13
 - Control cables, 4-11

- Mains, 4-6
- Motor, 4-7
 - Temperature monitoring, 4-12

- Connection diagram
 - Control connections, 4-13
 - Power connection, 4-10
- Connections, Power, 4-6
- Control cables, 4-11
- Control connections, 4-11
- Control mode, permissible, 5-6
- Control terminals, 4-12
 - Protection against polarity reversal, 4-12
 - Survey, 4-12
 - Terminal assignment, 4-12
- Controller, 1-1
 - Application as directed, 1-2
 - Labelling, 1-2
- Current limit, 5-5

D

- Deceleration times, 5-4
- Definitions of terminology used, 1-1
- Degree of pollution, 2-1
- Derating, 5-5
- Dimensions
 - 822X with fixing brackets, 4-2
 - 822X-V003 cold plate, 4-3
 - 824X with fixing brackets, 4-2
 - 824X-V003 cold plate, 4-4
 - Controller, 3-8
- Display
 - LED-, 8-1
 - Operating status, 8-1
- Drive parameters, Factory setting, 5-2
- Drive system, 1-1

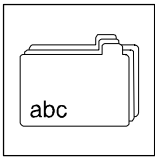

Index

E

Electrical installation, 4-5
Important notes, 4-5

EMC

Assembly, 4-14
CE-typical drive system, Installation, 4-14
Filters, 4-14
Grounding, 4-14
Installation, 4-14
Screening, 4-14

Enclosure, 2-1

F

Factory setting

Important drive parameters, 5-2
Short set-up, 5-2
Switch-on sequence, 5-2

Fans, Application of 82XX, 3-6

Fault analysis, 8-2

Fault messages, 8-3
Reset, 8-5

Field frequency

maximum, 5-3
minimum, 5-3

Frequency inverter. See Controller

Fuses

in UL-approved systems, 3-7
Single drives, 3-7
120 % overload, 3-8
150 % overload, 3-7

G

General data, 2-1

H

Heat-conducting paste, 4-3

History buffer, 8-2
Structure, 8-2

I

Initial switch-on, 5-1

Inputs

analog, 4-12
digital, 4-12

Installation, 4-1

CE-typical drive system, 4-14
Assembly, 4-14
Filters, 4-14
Grounding, 4-14
Screening, 4-14
electrical, 4-5
mechanische, 4-1

Installation height, 2-1

Insulation strength, 2-1

J

Jumper, Analog setpoint selection, 4-12

L

Labelling, Controller, 1-2

LED, 8-1

Legal regulations, 1-2

Liability, 1-2

M

Mains connection, 4-6

Mains-voltage compensation, 5-9

Maloperation of the drive, 8-2

Manufacturer, 1-2

Mechanical installation, 4-1

Messages, Fault, 8-3

Monitor output, 4-12

Monitoring, Motor temperature, 4-12

Motor, Adapt, 5-6

Motor cable, Screening, 4-7

Motor connection, 4-7

Types 822X, 4-7
Types 824X, 4-8

Mounting positions, Types 822X/824X, 4-1

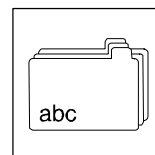
**N**

Noise emission, 2-1
Noise immunity, 2-1

O

Operating module, Fault display, 8-1
Operating status, Display, 8-1
Operation, Status display, 8-1
Operator's safety, 2-2
Outputs, analog, 4-12
Overspeeds, 2-2

P

Packaging, 2-1
Permissible moisture, 2-1
Power connections, 4-6
Protection against contact, 4-12
Protection against polarity reversal, 4-12
Pumps, Application of 82XX, 3-6

R

Rated data
Types 8221-8224, 150 % overload, 3-2
Types 8225-8227, 150 % overload, 3-3
Types 822X, 120 % overload, 3-6
Types 8241-8243, 150 % overload, 3-4
Types 8244-8246, 150 % overload, 3-5
Types 824X, 120 % overload, 3-6
Relay output, 4-12
Reset, Fault message, 8-5
Residual hazards, 2-2

S

Safety information, 2-1
for controllers to Low-Voltage Directive, 2-1
Layout, 2-2
Safety notes, Layout
Other notes, 2-2
Warning of damage to material, 2-2
Warning of danger to persons, 2-2
Scope of delivery, 1-1
Screening
EMC, 4-14
Motor cable, 4-7
Short set-up, 5-2
Switch-on, Initial, 5-1
Switch-on sequence, Factory setting, 5-2

T

Technical data, 2-1
General data/application conditions, 2-1
Temperature monitoring, 4-12
Temperature ranges, 2-1
Transport, storage, 2-1
TRIP, 8-5
Troubleshooting, 8-1
Display at the operating module, 8-1
Fault analysis using the history buffer, 8-2
Fault indication, 8-3
LED, 8-1
Maloperation of the drive, 8-2
Reset of fault indications, 8-5
TRIP, 8-5

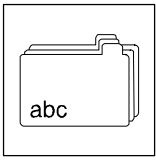

Index

U

Unit protection, 2-2

V

Variant

822X-V003, 4-3

824X-V003, 4-4

Cold plate, 4-3

V003, 4-3

Vibration resistance, 2-1

W

Warranty, 1-2

Waste disposal, 1-2

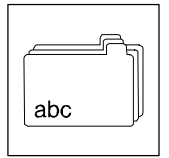

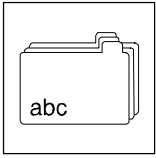

Index