

EDB8220E-V020
00454071

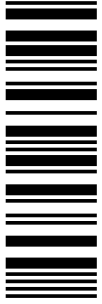

Lenze

Operating Instructions

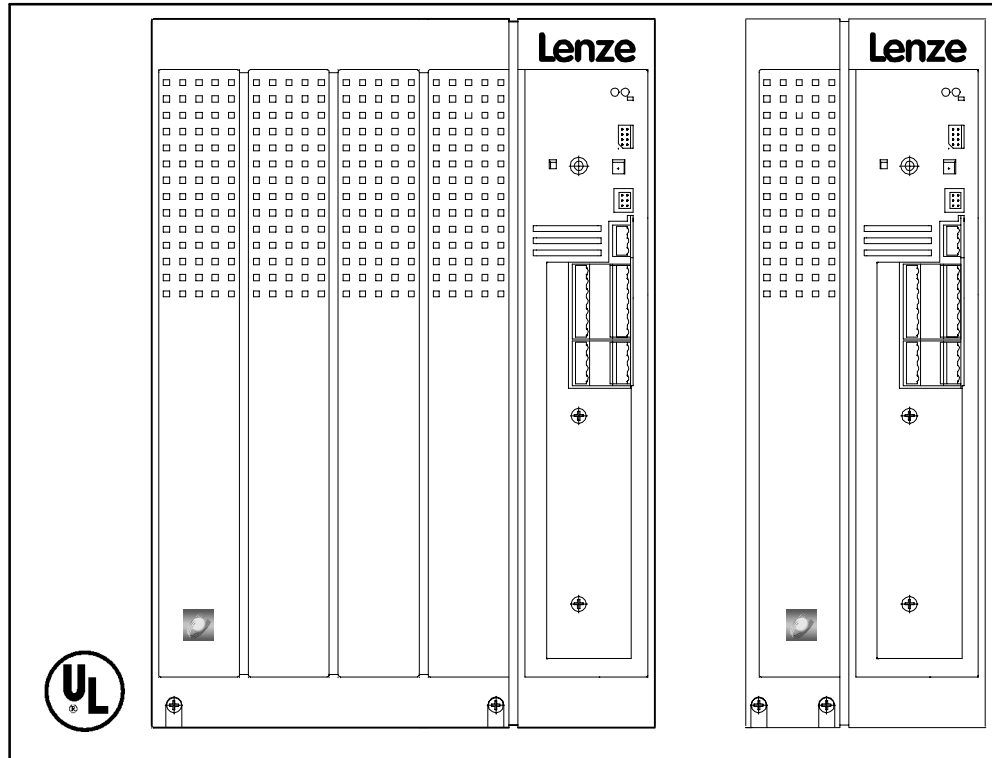

Global Drive

Frequency Inverters

8220/8240 HVAC Series

*HVAC and Pump Drives
Power Range 0.37 - 110 kW*

These Operating Instructions are valid for the 82XX controllers of the versions:

	33.822X-	E-	0x.	3x.	-V020	(8221 - 8227)
	33.824X-	E-	1x.	3x.	-V020	(8241 - 8246)
Type						
Design: B = Module C = Cold Plate E = Enclosure IP20						
Hardware level and index						
Software level and index						
Variante						
Explanation						

		revised	
Edition of:	01/03/1999	10/2002	

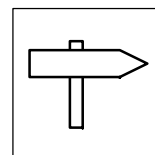

1	Preface and general information	1-1
1.1	About these Operating Instructions ...	1-1
1.1.1	Terminology used	1-1
1.1.2	Changes in these Operating Instructions	1-1
1.2	Scope of delivery	1-1
1.3	Legal regulations	1-2
2	Safety information	2-1
2.1	General safety information	2-1
2.2	Layout of the safety information	2-2
2.3	Residual hazards	2-2
3	Technical data	3-1
3.1	General data/application conditions	3-1
3.2	Rated data (Operation with 120 % overload)	3-2
3.2.1	Operating conditions	3-2
3.2.2	Types 8221 to 8224	3-3
3.2.3	Types 8225 to 8227	3-4
3.2.4	Types 8241 to 8243	3-5
3.2.5	Types 8244 to 8246	3-6
3.3	Rated data (Operation with 150 % overload)	3-7
3.3.1	Types 8221 to 8224	3-7
3.3.2	Types 8225 to 8227	3-8
3.3.3	Types 8241 to 8243	3-9
3.3.4	Types 8244 to 8246	3-10
3.4	Fuses and cable cross-sections	3-11
3.4.1	Operation of controllers in a UL-approved system	3-11
3.4.2	Single drives with 120 % overload	3-11
3.4.3	Single drives with 150 % overload	3-12
3.5	Analog plug-in module	3-13
3.5.1	Features	3-13
3.6	Dimensions	3-14
3.6.1	Controller dimensions	3-14
3.6.2	Analog plug-in module	3-14

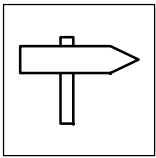

Contents

4	Installation	4-1
4.1	Mechanical installation	4-1
4.1.1	Important notes	4-1
4.1.2	Standard assembly with fixing brackets	4-2
4.1.3	Assembly of analog plug-in module	4-3
4.2	Electrical installation	4-4
4.2.1	Important notes	4-4
4.2.2	Power connections	4-5
4.2.2.1	Mains connection	4-5
4.2.2.2	Motor connection	4-6
4.2.2.3	Connection diagram	4-9
4.2.3	Control connections	4-10
4.2.3.1	Control cables	4-10
4.2.3.2	Assignment of the control terminals	4-11
4.2.3.3	Connection diagrams	4-12
4.2.3.4	Connection diagrams of analog plug-in modules	4-13
4.3	Installation of a CE-typical drive system	4-14
5	Commissioning	5-1
5.1	Before you switch on	5-1
5.2	Short set-up (factory setting)	5-2
5.2.1	Switch-on sequence	5-2
5.2.2	Factory setting of the most important drive parameters	5-2
5.3	Adapt machine data	5-3
5.3.1	Determine speed range (f_{dmin} , f_{dmax})	5-3
5.3.2	Adjustment of acceleration and deceleration times (T_{ir} , T_{if})	5-4
5.3.3	Setting of the current limit (I_{max})	5-5
5.4	Optimisation of the operating characteristic of the drive	5-6
5.4.1	Select the control mode	5-6
5.4.2	Optimisation of operating modes	5-8
5.4.2.1	Optimisation of V/f characteristic control with constant V_{min} boost	5-8
5.4.2.2	Optimisation of motor-current control	5-10
5.5	Operation with the PID-controller	5-11
5.5.1	Standardisation of process value	5-12
5.6	Application examples	5-13
5.6.1	Air conditioning	5-13
5.6.2	Pump application with pressure control	5-16
5.6.3	Pump application with level control	5-18
5.7	Signal-flow charts	5-20

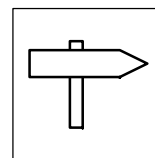

6	During operation	6-1
7	Configuration	7-1
7.1	Basics	7-1
7.2	Code table	7-2
8	Troubleshooting and fault elimination	8-1
8.1	Troubleshooting	8-1
8.1.1	Display at the controller	8-1
8.1.2	Display at the operating module	8-1
8.1.3	Maloperation of the drive	8-2
8.2	Fault analysis using the history buffer	8-2
8.3	Fault indications	8-3
8.4	Reset of fault indications	8-5
9	Accessories (Overview)	9-1
9.1	Accessories for all types	9-1
9.2	Software	9-1
9.3	Type-specific accessories	9-2
9.3.1	Types 822X	9-2
9.3.2	Types 824X	9-3
10	Index	10-1

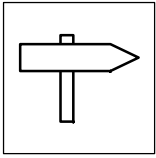

Contents

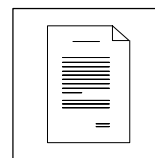

1 Preface and general information

1.1 About these Operating Instructions ...

- These Operating Instructions help you to connect and set up the 82XX frequency inverter. They contain safety information which must be observed.
- All persons who work on and with 82XX frequency inverters must have the Operating Instructions available and observe all relevant notes and instructions.
- The Operating Instructions must always be in a complete and perfectly readable state.

1.1.1 Terminology used

Term	In the following text used for
82XX	Any frequency inverter of the series 8210, 8220, 8240
Controller	82XX frequency inverter
Drive system	Drive systems with 82XX frequency inverters and other Lenze drive components

1.1.2 Changes in these Operating Instructions

Material No.	Edition	Important	Contents
398946	15/11/1997	1. edition	
	01/04/1998	2. edition	<ul style="list-style-type: none"> • Chapter 3 • Chapter 5.5 • Editorial update
	01/03/1999	3. edition	<ul style="list-style-type: none"> • Chapter 5.6.4: cancelled
454071	10/2002	replaces 398946	<ul style="list-style-type: none"> • Change of company name • Chapter 5.1 • Chapter 8.3

1.2 Scope of delivery

Scope of delivery	Important
<ul style="list-style-type: none"> • 1 82XX frequency inverter • 1 Operating Instructions • 1 accessory kit (components for the mechanical and electric installation) 	<p>After receipt of the delivery, check immediately whether the scope of supply matches with the accompanying papers. Lenze does not accept any liability for deficiencies claimed subsequently.</p> <p>Claim</p> <ul style="list-style-type: none"> • visible transport damage immediately to the forwarder. • visible deficiencies/incompleteness immediately to your Lenze representative.

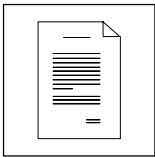

Preface and general information

1.3 Legal regulations

Labelling	Nameplate	CE mark	Manufacturer
	Lenze controllers are unambiguously designated by the content of the nameplate.	Conforms to the EC Low Voltage Directive	Lenze Drive Systems GmbH Postfach 10 13 52 D-31763 Hameln
Application as directed	<p>82XX frequency inverter</p> <ul style="list-style-type: none"> • must only be operated under the conditions prescribed in these Instructions. • are components <ul style="list-style-type: none"> - used for open and closed loop control of variable speed drives with asynchronous standard motors, reluctance motors, PM-synchronous motors with asynchronous damping cage. - used for installation into a machine. - used for assembly together with other components to form a machine. • are electric units for the installation into control cabinets or similar enclosed operating housing. • comply with the requirements of the Low-Voltage Directive. • are not machines for the purpose of the Machinery Directive. • are not to be used as domestic appliances, but only for industrial purposes. <p>Drive systems with 82XX frequency inverters</p> <ul style="list-style-type: none"> • comply with the EMC Directive if they are installed according to the guidelines of CE-typical drive systems. • can be used <ul style="list-style-type: none"> - on public and non-public mains. - in industrial as well as residential and commercial premises. • The user is responsible for the compliance of his application with the EC directives. <p>Any other use shall be deemed inappropriate!</p>		
Liability	<ul style="list-style-type: none"> • The information, data and notes in these Operating Instructions met the state of the art at the time of printing. Claims referring to drive systems which have already been supplied cannot be derived from the information, illustrations, and descriptions given in these Operating Instructions. • The specifications, processes, and circuitry described in these Operating Instructions are for guidance only and must be adapted to your own specific application. Lenze does not take responsibility for the suitability of the process and circuit proposals. • The indications given in these Operating Instructions describe the features of the product without warranting them. • Lenze does not accept any liability for damage and operating interference caused by: <ul style="list-style-type: none"> - disregarding these Instructions - unauthorized modifications to the controller - operating errors - improper working on and with the controller 		
Warranty	<ul style="list-style-type: none"> • Warranty conditions: see Sales and Delivery Conditions of Lenze Drive Systems GmbH. • Warranty claims must be made immediately after detecting defects or faults. • The warranty is void in all cases where liability claims cannot be made. 		
Disposal	Material	recycle	dispose
	Metal	●	-
	Plastic	●	-
	Printed-board assemblies	-	●



2 Safety information

2.1 General safety information



Safety and application notes for controllers

(to: Low-Voltage Directive 73/23/EEC)

1. General

During operation, drive controllers may have, according to their type of protection, live, bare, in some cases also movable or rotating parts as well as hot surfaces.

Non-authorized removal of the required cover, inappropriate use, incorrect installation or operation, creates the risk of severe injury to persons or damage to material assets.

Further information can be obtained from the documentation.

All operations concerning transport, installation, and commissioning as well as maintenance must be carried out by qualified, skilled personnel (IEC 364 and CENELEC HD 384 or DIN VDE 0100 and IEC report 664 or DIN VDE 0110 and national regulations for the prevention of accidents must be observed).

According to this basic safety information qualified skilled personnel are persons who are familiar with the erection, assembly, commissioning, and operation of the product and who have the qualifications necessary for their occupation.

2. Application as directed

Drive controllers are components which are designed for installation in electrical systems or machinery.

When installing in machines, commissioning of the drive controllers (i.e. the starting of operation as directed) is prohibited until it is proven that the machine corresponds to the regulations of the EC Directive 89/392/EEC (Machinery Directive); EN 60204 must be observed.

Commissioning (i.e. starting of operation as directed) is only allowed when there is compliance with the EMC Directive (89/336/EEC).

The drive controllers meet the requirements of the Low Voltage Directive 73/23/EEC. The harmonized standards of the prEN 50178/ DIN VDE 0160 series together with EN 60439-1/DIN VDE 0660 part 500 and EN 60146/DIN VDE 0558 are applicable to drive controllers.

The technical data and information on the connection conditions must be obtained from the nameplate and the documentation and must be observed in all cases.

3. Transport, storage

Notes on transport, storage and appropriate handling must be observed.

Climatic conditions must be observed according to prEN 50178.

4. Erection

The devices must be erected and cooled according to the regulations of the corresponding documentation.

The drive controllers must be protected from inappropriate loads. Particularly during transport and handling, components must not be bent and/or isolating distances must not be changed. Touching of electronic components and contacts must be avoided.

Drive controllers contain electrostatically sensitive components which can easily be damaged by inappropriate handling. Electrical components must not be damaged or destroyed mechanically (health risks are possible!).

5. Electrical connection

When working on live drive controllers, the valid national regulations for the prevention of accidents (e.g. VBG 4) must be observed.

The electrical installation must be carried out according to the appropriate regulations (e.g. cable cross-sections, fuses, PE connection). More detailed information is included in the documentation.

Notes concerning the installation in compliance with EMC - such as screening, grounding, arrangement of filters and laying of cables - are included in the documentation of the drive controllers. These notes must also be observed in all cases for drive controllers with the CE mark. The compliance with the required limit values demanded by the EMC legislation is the responsibility of the manufacturer of the system or machine.

6. Operation

Systems where drive controllers are installed must be equipped, if necessary, with additional monitoring and protective devices according to the valid safety regulations, e.g. law on technical tools, regulations for the prevention of accidents, etc. Modifications of the drive controllers by the operating software are allowed.

After disconnecting the drive controllers from the supply voltage, live parts of the controller and power connections must not be touched immediately, because of possibly charged capacitors. For this, observe the corresponding labels on the drive controllers. During operation, all covers and doors must be closed.

7. Maintenance and servicing

The manufacturer's documentation must be observed.

This safety information must be kept!

The product-specific safety and application notes in these Operating Instructions must also be observed!



Safety information

2.2 Layout of the safety information

- All safety notes have a uniform layout:
 - The icon characterizes the type of danger.
 - The signal word characterizes the severity of danger.
 - The note describes the danger and suggests how to avoid the danger.



Signal word

Note

	Icons used		Signal words	
Warning of danger to persons		Warning of hazardous electrical voltage	Danger!	Warns of impending danger . Consequences if disregarded: Death or very severe injuries.
		Warning of a general danger	Warning!	Warns of potential, very hazardous situations . Possible consequences if disregarded: Death or very severe injuries.
Warning of damage to material			Caution!	Warns of potential, hazardous situations . Possible consequences if disregarded: Light or minor injuries.
			Stop!	Warns of potential damage to material . Possible consequences if disregarded: Damage of the controller/drive system or its environment.
Other notes			Note!	This note designates general, useful notes. If you observe it, handling of the controller/drive system is made easier.

2.3 Residual hazards

Operator's safety	After mains disconnections, the power terminals U, V, W and +U _G , -U _G remain live for at least three minutes. <ul style="list-style-type: none"> • Before working on the controller, check that no voltage is applied to the power terminals.
Protection of devices	Cyclic connection and disconnection of the controller supply voltage at L1, L2, L3 or +U _G , -U _G may overload the internal input current load: <ul style="list-style-type: none"> • Allow at least 3 minutes between disconnection and reconnection.
Overspeeds	Drive systems can reach dangerous overspeeds (e. g. setting of inappropriately high field frequencies): <ul style="list-style-type: none"> • The controllers do not offer any protection against these operating conditions. Use additional components for this.

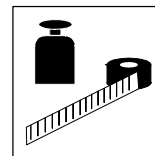

3 Technical data

3.1 General data/application conditions

Field	Values		
Vibration resistance	Germanischer Lloyd, general conditions		
Humidity class	Humidity class F without condensation (average relative humidity 85 %)		
Permissible temperature ranges	during transport of the controller: -25 °C ... +70 °C		
	during storage of the controller: -25 °C ... +55 °C		
	during operation of the controller: 0 °C ... +40 °C without power derating +40 °C ... +50 °C with power derating		
Permissible installation height h	h ≤ 1000m amsl without power derating		
	1000 m a.m.s.l. < h ≤ 4000 m a.m.s.l. with power derating		
Degree of pollution	VDE 0110 part 2 pollution degree 2		
Noise emission	Requirements acc. to EN 50081-2, EN 50082-1, IEC 22G-WG4 (Cv) 21 Limit value class A to EN 55011 (industrial area) with mains filter Limit value class B to EN 55022 (residential area) with mains filter and installation into control cabinet		
Noise immunity	Limit values maintained usig mains filter Requirements according to EN 50082-2, IEC 22G-WG4 (Cv) 21		
	Requirements	Standard	Severities
	ESD	EN61000-4-2	3, i.e. 8 kV with air discharge 6 kV with contact discharge
	RF interference(enclosure)	EN61000-4-3	3, i.e. 10 V/m; 27...1000 MHz
	Burst	EN61000-4-4	3/4, i.e. 2 kV/5 kHz
	Surge (Surge on mains cable)	EN 61000-4-5	3, i.e. 1.2/50 µs, 1 kV phase-phase, 2 kV phase-PE
Insulation strength	Overvoltage category III according to VDE 0110		
Packaging to DIN 4180	Types 824X	Dust packaging	
	Types 822X	Transport packaging	
Type of protection		IP20 NEMA 1: Protection against contact	
		IP 41 on the heat-sink side with thermal separation in push-through technique	
Approvals		CE: Low-Voltage Directive and Electromagnetic Compatibility	
		UL 508: Industrial Control Equipment UL 508C: Power Conversion Equipment	

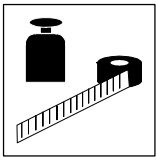

3.2 Rated data (Operation with 120 % overload)

3.2.1 Operating conditions

- Applications:
 - Pumps with square characteristic and fans
- Operation only with
 - mains filter or mains choke.
 - a mains voltage of 3 AC / 400 V / 50 Hz/60 Hz.
- Adapt mains-side accessories to the increased mains current:
 - For fuses and cable cross-sections see chapter 3.4.2
 - For data of other components see "Accessories".
- Automatic chopper frequency reduction to 4 kHz if the output current indicated is exceeded.

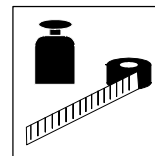

3.2.2 Types 8221 to 8224

120 % overload		Type	8221	8222	8223 ⁴⁾	8224
		Order no.	EVF8221-E-V020	EVF8222-E-V020	EVF8223-E-V020	EVF8224-E-V020
Mains voltage		V_{rated} [V]	320 V - 0% $\leq V_{rated} \leq$ 440 V + 0%; 45 Hz - 65 Hz \pm 0%			
Alternative DC supply		V_{DC} [V]	460 V - 0% $\leq V_{DC} \leq$ 620 V + 0%			
Mains current with mains filter/mains choke		I_{mains} [A]	39.0	50.0	60.0	97.0
Data for mains operation with 3 AC / 400 V / 50 Hz/60 Hz ; 460 V $\leq V_{DC} \leq$ 620 V						
Motor power (4 pole ASM) off 4kHz/8kHz*		P_{rated} [kW]	22	30	37.5	55
		P_{rated} [hp]	30	40	50	74
Output power U, V, W off 4 kHz/8 kHz*		S_{rated4} [kVA]	29.8	39.5	46.4	74.8
		S_{rated8} [kVA]	22.2	32.6	41.6	61.7
Output power + U_G , - U_G ¹⁾		P_{DC} [kW]	10.2	4.0	0	5.1
Output current	4 kHz*	I_{rated4} [A]	43	56	66	100
	8 kHz*	I_{rated8} [A]	32	47	59	89
	12 kHz*	$I_{rated12}$ [A]	27	40	50	62
	16 kHz*	$I_{rated16}$ [A]	24	35	44	54
	noise optimized 4 kHz*	I_{rated4} [A]	32	47	59	89
	noise optimized 8 kHz*	I_{rated8} [A]	29	43	47 ⁵⁾	59 ⁵⁾
	noise optimized 12 kHz*	$I_{rated12}$ [A]	25	37	44	54
	noise optimized 16 kHz*	$I_{rated16}$ [A]	21	30	35	46
Max. output current for 60s ²⁾	4 kHz*	$I_{rated\ max4}$ [A]	48	70.5	89	134
	8 kHz*	$I_{rated\ max8}$ [A]	48	70.5	89	134
	12 kHz*	$I_{rated\ max12}$ [A]	40	59	75	92
	16 kHz*	$I_{rated\ max16}$ [A]	36	53	66	81
	noise optimized 4 kHz*	$I_{rated\ max4}$ [A]	48	70.5	89	134
	noise optimized 8 kHz*	$I_{rated\ max8}$ [A]	43	64	70 ⁵⁾	88 ⁵⁾
	noise optimized 12 kHz*	$I_{rated\ max12}$ [A]	38	56	66	81
	noise optimized 16 kHz*	$I_{rated\ max16}$ [A]	31	46	53	69
Motor voltage ³⁾		V_M [V]	0 - 3 $\times V_{mains}$ / 0Hz ... 50Hz, if required up to 480Hz			
Power loss (Operation with I_{Nx})		P_V [W]	640	810	810	1350
Power derating		[%/K] [%/m]	40 °C < T_{amb} < 50 °C: 2.5%/K 1000 m a.m.s.l < h \leq 4000 m a.m.s.l: 5%/1000m			
Field frequency	Resolution	absolute	0.02 Hz			
	Digital setpoint selection	Accuracy	\pm 0.05 Hz			
	Analog setpoint selection	Linearity	\pm 0.5 % (max. selected signal level: 5 V or 10 V)			
		Temperature sensitivity	0 ... 40 °C: +0.4 %			
		Offset	\pm 0 %			
Weight		m [kg]	15	15	15	33,5

- 1) This power can be additionally obtained when operating a matching motor
 - 2) The currents apply to a periodical load cycle with 1 minute overcurrent with the current mentioned here and 2 minutes base load with 75% I_{Nx} .
 - 3) With mains choke/mains filter: max. output voltage = approx. 96 % of the mains voltage
 - 4) Max. permissible ambient temperature during operation +35 °C
 - 5) must only be operated with C144 = -1- (automatic chopper frequency reduction at $\vartheta_{max} = -5$ °C). Ensure not to exceed the currents.
- * Chopper frequency of the inverter

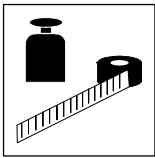

Technical Data

3.2.3 Types 8225 to 8227

120 % overload		Type	8225 ⁴⁾	8226	8227 ⁴⁾
		Order no.	EVF8225-E-V020	EVF8226-E-V020	EVF8227-E-V020
Mains voltage		V_{rated} [V]	320 V - 0% $\leq V_{rated} \leq$ 440 V + 0% ; 45 Hz ... 65 Hz \pm 0%		
Alternative DC supply		V_{DC} [V]	460 V - 0% $\leq V_{DC} \leq$ 620 V + 0%		
Mains current with mains filter/mains choke		I_{mains} [A]	119	144	185
Data for mains operation with 3 AC / 400 V / 50 Hz/60 Hz ; 460 V $\leq V_{DC} \leq$ 620 V					
Motor power (4 pole ASM) off 4kHz/8kHz*		P_{rated} [kW]	75	90	110
		P_{rated} [hp]	100	120	148
Output power U, V, W off 4 kHz/8 kHz*		S_{rated4} [kVA]	91.5	110	142
		S_{rated8} [kVA]	76.2	103.9	124.7
Output power $+U_G, -U_G$ ¹⁾		P_{DC} [kW]	0	28.1	40.8
Output current	4 kHz*	I_{rated4} [A]	135	159	205
	8 kHz*	I_{rated8} [A]	110	150	171
	12 kHz*	$I_{rated12}$ [A]	88	120	126
	16 kHz*	$I_{rated16}$ [A]	77	105	108
	noise optimized 4 kHz*	I_{rated4} [A]	110	150	159 ⁵⁾
	noise optimized 8 kHz*	I_{rated8} [A]	76 ⁵⁾	92 ⁵⁾	100 ⁵⁾
	noise optimized 12 kHz*	$I_{rated12}$ [A]	66	82	90
	noise optimized 16 kHz*	$I_{rated16}$ [A]	60	67	72
Max. output current for 60s ²⁾	4 kHz*	$I_{rated\ max4}$ [A]	165	225	270
	8 kHz*	$I_{rated\ max8}$ [A]	165	225	221
	12 kHz*	$I_{rated\ max12}$ [A]	114	156	164
	16 kHz*	$I_{rated\ max16}$ [A]	100	136	140
	noise optimized 4 kHz*	$I_{rated\ max4}$ [A]	165	225	238 ⁵⁾
	noise optimized 8 kHz*	$I_{rated\ max8}$ [A]	114 ⁵⁾	138 ⁵⁾	150 ⁵⁾
	noise optimized 12 kHz*	$I_{rated\ max12}$ [A]	85	107	117
	noise optimized 16 kHz*	$I_{rated\ max16}$ [A]	78	87	94
Motor voltage ³⁾		V_M [V]	0 - 3 $\times V_{mains}$ / 0Hz ... 50Hz, if required up to 480Hz		
Power loss (Operation with $I_{N\lambda}$)		P_v [W]	1470	2100	2400
Power derating		[%/K] [%/m]	40 °C $< T_{amb} <$ 50 °C: 2.5%/K 1000 m a.m.s.l $< h \leq$ 4000 m a.m.s.l: 5%/1000m		
Field frequency	Resolution	absolute	0.02 Hz		
	Digital setpoint selection	Accuracy	\pm 0.05 Hz		
	Analog setpoint selection	Linearity	\pm 0.5 % (max. selected signal level: 5 V or 10 V)		
		Temperature sensitivity	0 ... 40 °C: +0.4 %		
		Offset	\pm 0 %		
Weight		m [kg]	36.5	59	59

- 1) This power can be additionally obtained when operating a matching motor
 - 2) The currents apply to a periodical load cycle with 1 minute overcurrent with the current mentioned here and 2 minutes base load with 75% $I_{N\lambda}$.
 - 3) With mains choke/mains filter: max. output voltage = approx. 96 % of the mains voltage
 - 4) Max. permissible ambient temperature during operation +35 °C
 - 5) must only be operated with C144 = -1- (automatic chopper frequency reduction at $\vartheta_{max} = -5$ °C). Ensure not to exceed the currents.
- * Chopper frequency of the inverter

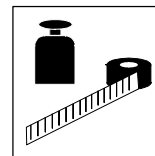

3.2.4 Types 8241 to 8243

120 % overload		Type	8241	8242	8243
		Order no.	EVF8241-E-V020	EVF8242-E-V020	EVF8243-E-V020
Mains voltage		V_{rated} [V]	$320V \pm 0\% \leq V_{rated} \leq 440V \pm 0\%$; 45Hz ... 65Hz $\pm 0\%$		
Alternative DC supply		V_{DC} [V]	$460V \pm 0\% \leq V_{DC} \leq 620V \pm 0\%$		
Mains current with mains filter/mains choke		I_{mains} [A]	1.7	2.8	5.0
Data for mains operation with 3 AC / 400 V / 50 Hz/60 Hz ; $460V \leq V_{DC} \leq 620V$					
Motor power (4 pole ASM) off 4kHz/8kHz*		P_{rated} [kW]	0.55	1.1	2.2
		P_{rated} [hp]	0.75	1.5	2.9
Output power U, V, W off 4 kHz/8 kHz*		S_{rated4} [kVA]	1.3	2.1	3.8
		S_{rated8} [kVA]	1.0	1.7	2.7
Output power $+U_G, -U_G$ ¹⁾		P_{DC} [kW]	1.9	0.7	0
Output current	4 kHz*	I_{rated4} [A]	1.8	3.0	5.5
	8 kHz*	I_{rated8} [A]	1.5	2.5	3.9
	12kHz*	$I_{rated12}$ [A]	1.35	2.2	3.5
	16 kHz*	$I_{rated16}$ [A]	1.2	2.0	3.1
	noise optimized 4 kHz*	I_{rated4} [A]	1.5	2.5	3.9
	noise optimized 8 kHz*	I_{rated8} [A]	1.3	2.2	2.9
	noise optimized 12 kHz*	$I_{rated12}$ [A]	1.3	2.1	3.4
	noise optimized 16 kHz*	$I_{rated16}$ [A]	1.1	1.8	2.9
Max. output current for 60s ²⁾	4 kHz*	$I_{rated\ max4}$ [A]	2.25	3.6	6.6
	8 kHz*	$I_{rated\ max8}$ [A]	2.2	3.7	5.8
	12 kHz*	$I_{rated\ max12}$ [A]	2.0	3.3	5.2
	16 kHz*	$I_{rated\ max16}$ [A]	1.8	3.0	4.7
	noise optimized 4 kHz*	$I_{rated\ max4}$ [A]	2.3	3.8	5.8
	noise optimized 8 kHz*	$I_{rated\ max8}$ [A]	2.0	3.2	5.0
	noise optimized 12 kHz*	$I_{rated\ max12}$ [A]	1.9	3.2	5.1
	noise optimized 16 kHz*	$I_{rated\ max16}$ [A]	1.6	2.7	4.3
Motor voltage ³⁾		V_M [V]	0 - $3 \times V_{mains}$ / 0Hz ... 50Hz, if required up to 480Hz		
Power loss (Operation with I_{Nk})		P_v [W]	50	65	115
Power derating		[%/K] [%/m]	$40\text{ °C} < T_{amb} < 50\text{ °C}$: 2.5%/K $1000\text{ m a.m.s.l} < h \leq 4000\text{ m a.m.s.l}$: 5%/1000m		
Field frequency	Resolution	absolute	0.02 Hz		
	Digital setpoint selection	Accuracy	± 0.05 Hz		
	Analog setpoint selection	Linearity	$\pm 0.5\%$ (max. selected signal level: 5 V or 10 V)		
		Temperature sensitivity	0 ... 40 °C: +0.4 %		
	Offset		$\pm 0\%$		
Weight		m [kg]	3.5	3.5	5.0

- 1) This power can be additionally obtained when operating a matching motor
 - 2) The currents apply to a periodical load cycle with 1 minute overcurrent with the current mentioned here and 2 minutes base load with 75% I_{Nk} .
 - 3) With mains choke/mains filter: max. output voltage = approx. 96 % of the mains voltage
- * Chopper frequency of the inverter

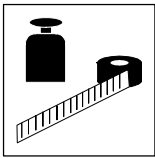

Technical Data

3.2.5 Types 8244 to 8246

120 % overload		Type	8244	8245	8246
		Order no.	EVF8244-E-V020	EVF8245-E-V020	EVF8246-E-V020
Mains voltage		V_{rated} [V]	$320V \pm 0\% \leq V_{rated} \leq 440V \pm 0\%$; 45Hz ... 65Hz $\pm 0\%$		
Alternative DC supply		V_{DC} [V]	$460V \pm 0\% \leq V_{DC} \leq 620V \pm 0\%$		
Mains current with mains filter/mains choke		I_{mains} [A]	8.8	15.0	20.5
Data for mains operation with 3 AC / 400 V / 50 Hz/60 Hz ; $460V \leq V_{DC} \leq 620V$					
Motor power (4 pole ASM) off 4kHz/8kHz*		P_{rated} [kW]	4.4	7.5	11.0
		P_{rated} [hp]	5.4	10.0	15.0
Output power U, V, W off 4 kHz/8 kHz*		S_{rated4} [kVA]	6.5	11.1	16.3
		S_{rated8} [kVA]	4.8	9.0	16.3
Output power $+U_G, -U_G$ ¹⁾		P_{DC} [kW]	2.0	0	0
Output current	4 kHz*	I_{rated4} [A]	9.2	16.0	23.5
	8 kHz*	I_{rated8} [A]	7.0	13.0	23.5
	12 kHz*	$I_{rated12}$ [A]	6.3	11.7	20.0
	16 kHz*	$I_{rated16}$ [A]	5.6	10.4	16.5
	noise optimized 4 kHz*	I_{rated4} [A]	7.0	13.0	23.5
	noise optimized 8 kHz*	I_{rated8} [A]	6.0	11.1	20.0
	noise optimized 12 kHz*	$I_{rated12}$ [A]	6.1	11.3	19.4
	noise optimized 16 kHz*	$I_{rated16}$ [A]	5.2	9.7	15.2
Max. output current for 60s ²⁾	4 kHz*	$I_{rated\ max4}$ [A]	11.0	19.5	35.3
	8 kHz*	$I_{rated\ max8}$ [A]	10.5	19.5	35.0
	12 kHz*	$I_{rated\ max12}$ [A]	9.5	17.5	30.0
	16 kHz*	$I_{rated\ max16}$ [A]	8.4	15.6	24.6
	noise optimized 4 kHz*	$I_{rated\ max4}$ [A]	10.5	19.5	35.5
	noise optimized 8 kHz*	$I_{rated\ max8}$ [A]	7.8	14.5	22.9
	noise optimized 12 kHz*	$I_{rated\ max12}$ [A]	9.1	16.5	29.0
	noise optimized 16 kHz*	$I_{rated\ max16}$ [A]	7.8	14.5	22.9
Motor voltage ³⁾		V_M [V]	0 - $3 \times V_{mains}$ / 0Hz ... 50Hz, if required up to 480Hz		
Power loss (Operation with I_{Nk})		P_V [W]	165	260	360
Power derating		[%/K] [%/m]	40 °C < T_{amb} < 50 °C: 2.5%/K 1000 m a.m.s.l < h \leq 4000 m a.m.s.l: 5%/1000m		
Field frequency	Resolution	absolute	0.02 Hz		
	Digital setpoint selection	Accuracy	± 0.05 Hz		
	Analog setpoint selection	Linearity	$\pm 0.5\%$ (max. selected signal level: 5 V or 10 V)		
		Temperature sensitivity	0 ... 40 °C: +0.4 %		
		Offset	$\pm 0\%$		
Weight		m [kg]	5.0	7.5	7.5

1) This power can be additionally obtained when operating a matching motor

2) The currents apply to a periodical load cycle with 1 minute overcurrent with the current mentioned here and 2 minutes base load with 75% I_{Nk} .

3) With mains choke/mains filter: max. output voltage = approx. 96 % of the mains voltage

* Chopper frequency of the inverter

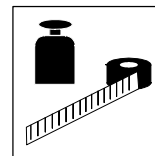

3.3 Rated data (Operation with 150 % overload)

Operation permitted with a mains voltage of
3AC / 400 V - 480V /50 Hz/60 Hz

3.3.1 Types 8221 to 8224

150 % overload		Type	8221	8222	8223	8224				
Mains voltage	V_{rated} [V]	320 V - 0% $\leq V_{rated} \leq$ 528 V + 0% ; 45 Hz ... 65 Hz \pm 0%								
Alternative DC supply	V_{DC} [V]	460 V - 0% $\leq V_{DC} \leq$ 740 V + 0%								
Mains current with mains filter/mains choke	I_{mains} [A]	29.0	42.0	55.0	80.0					
without mains filter/mains choke	I_{mains} [A]	43.5	--	--	--					
Data for mains operation with 3 AC / 400 V / 50 Hz/60 Hz ; 460 V $\leq V_{DC} \leq$ 620 V or 3 AC / 480 V / 50 Hz/60 Hz ; 460 V $\leq V_{DC} \leq$ 740 V										
			400 V	480 V	400 V	480 V	400 V	480 V	400 V	480 V
Motor power (4 pole ASM) off 4kHz/8kHz*	P_{rated} [kW]	15	18.5	22	30	30	37	45	55	
	P_{rated} [hp]	20	25	30	40	40	49.5	60	74	
Output power U, V, W off 4 kHz/8 kHz*	S_{rated8} [kVA]	22.2	26.6	32.6	39.1	41.6	49.9	61.7	73.9	
Output power +U _G , -U _G ¹⁾	P_{DC} [kW]	10.2	11.8	4.0	4.6	0	0	5.1	5.9	
Output current	4 kHz*	I_{rated4} [A]	32	32	47	47	59	56	89	84
	8 kHz*	I_{rated8} [A]	32	32	47	47	59	56	89	84
	12 kHz*	$I_{rated12}$ [A]	27	25	40	37	50	47	62	67
	16 kHz*	$I_{rated16}$ [A]	24	22	35	33	44	41	54	58
	noise optimized 4 kHz*	I_{rated4} [A]	32	30,5	47	45	59	56	89	84
	noise optimized 8 kHz*	I_{rated8} [A]	29	27	43	41	47 ³⁾	44 ³⁾	59 ³⁾	55 ³⁾
	noise optimized 12 kHz*	$I_{rated12}$ [A]	25	24	37	35	44	38	54	48
	noise optimized 16 kHz*	$I_{rated16}$ [A]	21	19	30	28	35	30	46	39
Max. output current for 60s ²⁾	4 kHz*	$I_{rated\ max4}$ [A]	48	48	70.5	70.5	89	84	134	126
	8 kHz*	$I_{rated\ max8}$ [A]	48	48	70.5	70.5	89	84	134	126
	12 kHz*	$I_{rated\ max12}$ [A]	40	38	59	56	75	70	92	87
	16 kHz*	$I_{rated\ max16}$ [A]	36	33	53	49	66	61	81	75
	noise optimized 4 kHz*	$I_{rated\ max4}$ [A]	48	46	70.5	66,5	89	56	134	126
	noise optimized 8 kHz*	$I_{rated\ max8}$ [A]	43	41	64	61	70 ³⁾	65 ³⁾	88 ³⁾	82 ³⁾
	noise optimized 12 kHz*	$I_{rated\ max12}$ [A]	38	36	56	53	66	57	81	75
	noise optimized 16 kHz*	$I_{rated\ max16}$ [A]	31	29	46	42	53	45	69	63
Power loss (Operation with I_{Nx})	P_v [W]	430		640		810		1100		

- 1) This power can be additionally obtained when operating a matching motor
 - 2) The currents apply to a periodical load cycle with 1 minute overcurrent with the current mentioned here and 2 minutes base load with 75% I_{Nx} .
 - 3) must only be operated with C144 = -1- (automatic chopper frequency reduction at $\vartheta_{max} = +5$ °C). Ensure not to exceed the currents.
- * Chopper frequency of the inverter
For all other data see chapter 3.2.2.

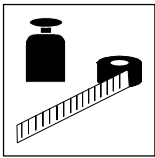

Technical Data

3.3.2 Types 8225 to 8227

150 % overload		Type	8225		8226		8227	
Mains voltage		V_{rated} [V]	320 V - 0% $\leq V_{rated} \leq$ 528 V + 0% ; 45 Hz ... 65 Hz \pm 0%					
Alternative DC supply		V_{DC} [V]	460 V - 0% $\leq V_{DC} \leq$ 740 V + 0%					
Mains current with mains filter/mains choke without mains filter/mains choke		I_{mains} [A]	100		135		165	
		I_{mains} [A]	--		--		--	
Data for mains operation with 3 AC / 400 V / 50 Hz/60 Hz ; 460 V $\leq V_{DC} \leq$ 620 V or 3 AC / 480 V / 50 Hz/60 Hz ; 460 V $\leq V_{DC} \leq$ 740 V								
Motor power (4 pole ASM) at 4 kHz/8 kHz*		P_{rated} [kW] P_{rated} [hp]	400 V	480 V	400 V	480 V	400 V	480 V
			55	75	75	90	90	110
Output power U, V, W at 4kHz/8 kHz*		S_{rated8} [kVA]	76.2	91.4	103.9	124	124.7	149
Output power $+U_G, -U_G$ ¹⁾		P_{DC} [kW]	0	0	28.1	32.4	40.8	47.1
Output current	4 kHz*	I_{rated4} [A]	110	105	150	142	180	171
	8 kHz*	I_{rated8} [A]	110	105	150	142	171	162
	12 kHz*	$I_{rated12}$ [A]	88	83	120	112	126	117
	16 kHz*	$I_{rated16}$ [A]	77	72	105	98	108	99
	noise optimized 4 kHz*	I_{rated4} [A]	110	104	150	141	159 ³⁾	149 ³⁾
	noise optimized 8 kHz*	I_{rated8} [A]	76 ³⁾	71 ³⁾	92 ³⁾	86 ³⁾	100 ³⁾	94 ³⁾
	noise optimized 12 kHz*	$I_{rated12}$ [A]	66	60	82	75	90	81
	noise optimized 16 kHz*	$I_{rated16}$ [A]	60	55	67	60	72	63
Max. output current for für 60s ²⁾	4 kHz*	$I_{rated max4}$ [A]	165	157	225	213	270	256
	8 kHz*	$I_{rated max8}$ [A]	165	157	225	213	221	211
	12 kHz*	$I_{rated max12}$ [A]	114	108	156	147	164	153
	16 kHz*	$I_{rated max16}$ [A]	100	94	136	128	140	130
	noise optimized 4 kHz*	$I_{rated max4}$ [A]	165	156	225	212	238 ³⁾	223 ³⁾
	noise optimized 8 kHz*	$I_{rated max8}$ [A]	114 ³⁾	107 ³⁾	138 ³⁾	169 ³⁾	150 ³⁾	141 ³⁾
	noise optimized 12 kHz*	$I_{rated max12}$ [A]	85	78	107	98	117	106
	noise optimized 16 kHz*	$I_{rated max16}$ [A]	78	72	87	78	94	83
Power loss (Operation with I_{Nk})		P_V [W]	1470		1960		2400	

¹⁾ This power can be additionally obtained when operating a matching motor

²⁾ The currents apply to a periodical load cycle with 1 minute overcurrent with the current mentioned here and 2 minutes base load with 75% I_{Nk} .

³⁾ must only be operated with C144 = -1- (automatic chopper frequency reduction at $\vartheta_{max} = +5$ °C). Ensure not to exceed the currents.

* Chopper frequency of the inverter
For all other data see chapter 3.2.3.

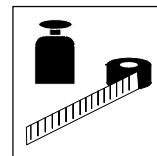

3.3.3 Types 8241 to 8243

150 % overload		Type	8241		8242		8243	
Mains voltage		$V_{rated}[V]$	320 V - 0% ≤ V_{rated} ≤ 528 V + 0% ; 45 Hz 065 Hz *0%					
Alternative DC supply		$V_{DC}[V]$	460 V - 0% ≤ V_{DC} ≤ 740 V + 0%					
Mains current								
with mains filter/mains choke		$I_{mains} [A]$	1.5		2.5		3.9	
without mains filter/mains choke		$I_{mains} [A]$	2.1		3.5		5.5	
Data for mains operation with 3 AC / 400 V / 50 Hz/60 Hz ; 460 V ≤ V_{DC} ≤ 620 V or 3 AC / 480 V / 50 Hz/60 Hz ; 460 V ≤ V_{DC} ≤ 740 V								
			400 V	480 V	400 V	480 V	400 V	480 V
Motor power (4 pole ASM)		$P_{rated} [kW]$	0.37	0.37	0.75	0.75	1.5	1.5
at 4 kHz/8 kHz*		$P_{rated} [hp]$	0.5	0.5	1.0	1.0	2.0	2.0
Output power U, V, W		$S_{rated8} [kVA]$	1.0	1.2	1.7	2.1	2.7	3.2
at 4kHz/8 kHz*								
Output power + U_G , - U_G ¹⁾		$P_{DC} [kW]$	1.9	2.3	0.7	0.9	0	0
Output current	4 kHz*	$I_{rated8} [A]$	1.5	1.5	2.5	2.5	3.9	3.9
	8 kHz*	$I_{rated8} [A]$	1.5	1.5	2.5	2.5	3.9	3.9
	12kHz*	$I_{rated12} [A]$	1.35	1.35	2.2	2.2	3.5	3.5
	16 kHz*	$I_{rated16} [A]$	1.2	1.2	2.0	2.0	3.1	3.1
	noise optimized 4 kHz*	$I_{rated4} [A]$	1.5	1.5	2.5	2.4	3.9	3.7
	noise optimized 8 kHz*	$I_{rated8} [A]$	1.3	1.3	2.2	2.1	2.9	2.8
	noise optimized 12 kHz*	$I_{rated12} [A]$	1.3	1.3	2.1	2.1	3.4	3.4
	noise optimized 16 kHz*	$I_{rated16} [A]$	1.1	1.1	1.8	1.8	2.9	2.9
Max. output current for für 60s ²⁾	4 kHz*	$I_{rated max8} [A]$	2.2	2.25	3.7	3.75	5.8	5.85
	8 kHz*	$I_{rated max8} [A]$	2.2	2.25	3.7	3.75	5.8	5.85
	12 kHz*	$I_{rated max12} [A]$	2.0	2.0	3.3	3.3	5.2	5.2
	16 kHz*	$I_{rated max16} [A]$	1.8	1.8	3.0	3.0	4.7	4.7
	noise optimized 4 kHz*	$I_{rated max4} [A]$	2.3	2.2	3.8	3.6	5.8	5.5
	noise optimized 8 kHz*	$I_{rated max8} [A]$	2.0	1.8	3.2	3.0	5.0	4.7
	noise optimized 12 kHz*	$I_{rated max12} [A]$	1.9	1.9	3.2	3.2	5.1	5.1
	noise optimized 16 kHz*	$I_{rated max16} [A]$	1.6	1.6	2.7	2.7	4.3	4.3
Power loss (Operation with I_{Nx})		$P_V [W]$	50		65		100	

1) This power can be additionally obtained when operating a matching motor

2) The currents apply to a periodical load cycle with 1 minute overcurrent with the current mentioned here and 2 minutes base load with 75% I_{Nx} .

* Chopper frequency of the inverter

For all other data see chapter 3.2.4.

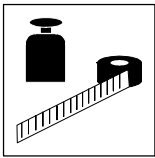

Technical Data

3.3.4 Types 8244 to 8246

150 % overload		Type	8244		8245		8246	
Mains voltage		V_{rated} [V]	320 V - 0% \leq V_{rated} \leq 528 V + 0% ; 45 Hz 065 Hz *0%					
Alternative DC supply		V_{DC} [V]	460 V - 0% \leq V_{DC} \leq 740 V + 0%					
Mains current with mains filter/mains choke		I_{mains} [A]	7.0		12.0		20.5	
without mains filter/mains choke		I_{mains} [A]	-		16.8		-	
Data for mains operation with 3 AC / 400 V / 50 Hz/60 Hz ; 460 V \leq V_{DC} \leq 620 V or 3 AC / 480 V / 50 Hz/60 Hz ; 460 V \leq V_{DC} \leq 740 V								
			400 V	480 V	400 V	480 V	400 V	480 V
Motor power (4 pole ASM) at 4 kHz/8 kHz*		P_{rated} [kW]	3.0	3.0	5.5	5.5	11.0	11.0
		P_{rated} [hp]	4.0	4.0	7.5	7.5	15.0	15.0
Output power U, V, W at 4kHz/8 kHz*		S_{rated8} [kVA]	4.8	5.8	9.0	10.8	16.3	10.8
Output power $+U_G, -U_G$ ¹⁾		P_{DC} [kW]	2.0	2.5	0	0	0	0
Output current	4 kHz*	I_{rated4} [A]	7.0	7.0	13.0	13.0	23.5	23.5
	8 kHz*	I_{rated8} [A]	7.0	7.0	13.0	13.0	23.5	23.5
	12 kHz*	$I_{rated12}$ [A]	6.3	6.3	11.7	11.7	20.0	19.1
	16 kHz*	$I_{rated16}$ [A]	5.6	5.6	10.4	10.4	16.5	15.7
	noise optimized 4 kHz*	I_{rated4} [A]	7.0	6.6	13.0	12.3	23.5	22.1
	noise optimized 8 kHz*	I_{rated8} [A]	6.0	5.6	11.1	10.4	20.0	18.8
	noise optimized 12 kHz*	$I_{rated12}$ [A]	6.1	6.1	11.3	11.3	19.4	18.4
	noise optimized 16 kHz*	$I_{rated16}$ [A]	5.2	5.2	9.7	9.7	15.2	14.6
Max. output current for für 60s ²⁾	4 kHz*	$I_{rated\ max8}$ [A]	10.5	10.5	19.5	19.5	35.0	33.5
	8 kHz*	$I_{rated\ max8}$ [A]	10.5	10.5	19.5	19.5	35.0	33.5
	12 kHz*	$I_{rated\ max12}$ [A]	9.5	9.5	17.5	17.5	30.0	28.7
	16 kHz*	$I_{rated\ max16}$ [A]	8.4	8.4	15.6	15.6	24.6	23.6
	noise optimized 4 kHz*	$I_{rated\ max4}$ [A]	10.5	8.4	19.5	15.6	35.5	28.2
	noise optimized 8 kHz*	$I_{rated\ max8}$ [A]	7.8	7.8	14.5	14.5	22.9	21.8
	noise optimized 12 kHz*	$I_{rated\ max12}$ [A]	9.1	9.1	16.5	16.5	29.0	27.6
	noise optimized 16 kHz*	$I_{rated\ max16}$ [A]	7.8	7.8	14.5	14.5	22.9	21.8
Power loss (Operation with $I_{N\lambda}$)		P_V [W]	150		210		360	

¹⁾ This power can be additionally obtained when operating a matching motor

²⁾ The currents apply to a periodical load cycle with 1 minute overcurrent with the current mentioned here and 2 minutes base load with 75% $I_{N\lambda}$.

* Chopper frequency of the inverter
For all other data see chapter 3.2.5.

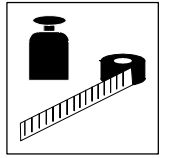

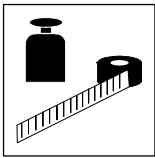

Technical Data

3.4.3 Single drives with 150 % overload

The table values are valid for the operation of 82XX controllers as single drives with a matching motor and 150 % overload.

Type	Mains input L1, L2, L3, PE/motor connection U, V, W, PE									
	Operation without mains filter/mains choke					Operation with mains filter/mains choke				
	Fuse F1, F2, F3		E.I.c.b.	Cable cross-section ¹⁾		Fuse F1, F2, F3		E.I.c.b.	Cable cross-section ¹⁾	
	VDE	UL	VDE	mm ²	AWG	VDE	UL	VDE	mm ²	AWG
8221	63A	--	--	16	5	M 35A	35A	--	10	7
8222	--	--	--	--	--	M 50A	50A	--	16	5
8223	--	--	--	--	--	M 80A	80A	--	25	3
8224	--	--	--	--	--	M 100A	100A	--	50	0
8225	--	--	--	--	--	M 125A	125A	--	70	2 / 0
8226	--	--	--	--	--	M 160A	175A	--	95	3 / 0
8227	--	--	--	--	--	M 200A	200A	--	120	4 / 0
8241	M 6A	5A	B 6A	1	17	M 6A	5A	B 6A	1	17
8242	M 6A	5A	B 6A	1	17	M 6A	5A	B 6A	1	17
8243	M 10A	10A	B 10A	1.5	15	M 10A	10A	B 10A	1.5	15
8244	--	--	--	--	--	M 10A	10A	B 10A	1.5	15
8245	M 25A	25A	B 25A	6	10	M 20A	20A	B 20A	4	11
8246	--	--	--	--	--	M 32A	25A	B 32A	6	10

¹⁾ Observe national and regional regulations (e. g. VDE/EVU)!

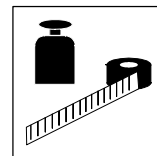

3.5 Analog plug-in module

3.5.1 Features

The analog plug-in module provides a second analog input. It converts an analog input signal (0 ... 10 V oder 0 ... 20 mA) into a digital signal (pulse frequency 0 ... 10 kHz, level: 0 ... 3V LOW and 12 ... 30V HIGH).

For operation with 4 ... 20 mA, the following codes must be changed:

C426 = 120%
C427 = -12.5%

For further information, please see the Code Table .

Inverters of the 8210, 8220 and 8240 series which are equipped with an analog plug-in module can be used for the following process controller applications:

- Pressure control
- Temperature or volume control
- Setpoint summation
- Speed or dancer-position control

To operate the analog plug-in module, the terminal configuration C007 has to be set to -28- ... -45- or -48- ... -51-.



Note!

Only inverters of the 8210, 8220 and 8240 series for HVAC and pump applications can be equipped with an analog plug-in module because they provide the required software.

Inverters with plug-in module are subject to the technical data and application conditions of controllers.

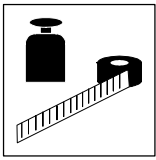

Technical Data

3.6 Dimensions

3.6.1 Controller dimensions

The controller dimensions depend on the mechanical installation (see chapter 4.1).

3.6.2 Analog plug-in module

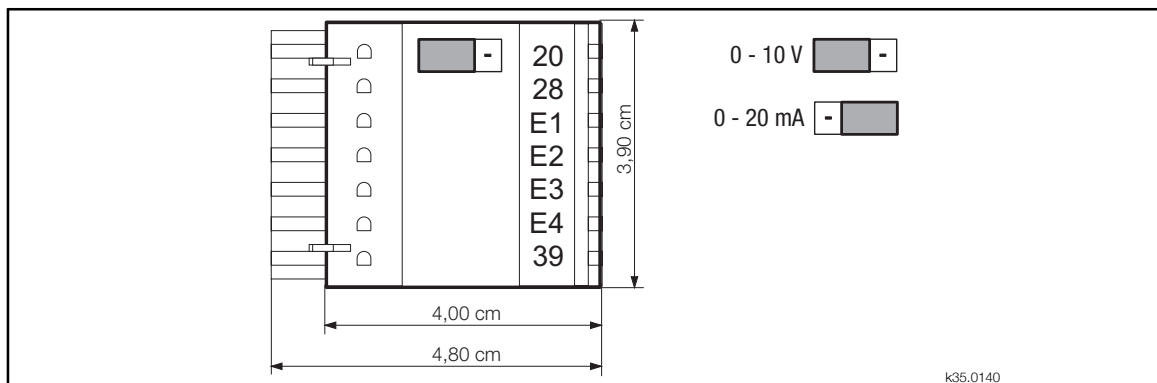
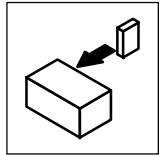

FIG 3-1 Dimensions of analog plug-in module



4 Installation

4.1 Mechanical installation

4.1.1 Important notes

- Use the controllers only as built-in devices!
- If the cooling air contains pollutants (dust, fluff, grease, aggressive gases):
 - take suitable preventive measures , e.g. separate air duct, installation of filters, regular cleaning, etc.
- Observe free space!
 - You can install several controllers next to each other without free space in a control cabinet.
 - Ensure unimpeded ventilation of cooling air and outlet of exhaust air!
 - Allow a free space of 100 mm at the top and at the bottom.
- Do not exceed the ambient temperature permissible during operation (see chapter. 3.1)
- With continuous oscillations or vibrations:
 - Check whether shock absorbers are necessary.

Possible mounting positions

- In vertical position at the back of the control cabinet, terminals point to the front:
 - With attached fixing brackets.
 - Thermally separated with external heat sink ("push-through technology").

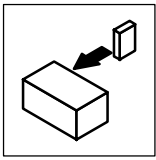

Installation

4.1.2 Standard assembly with fixing brackets

Assembly preparations for 822X (see FIG 4-1)

To assemble and install the controller it is necessary to remove the unit cover. The accessory kit inside the controller contains the parts required for the assembly and installation.

1. Loosen screws (x).
2. Swing cover to the top and detach.
3. Bolt the fixing brackets onto the housing.

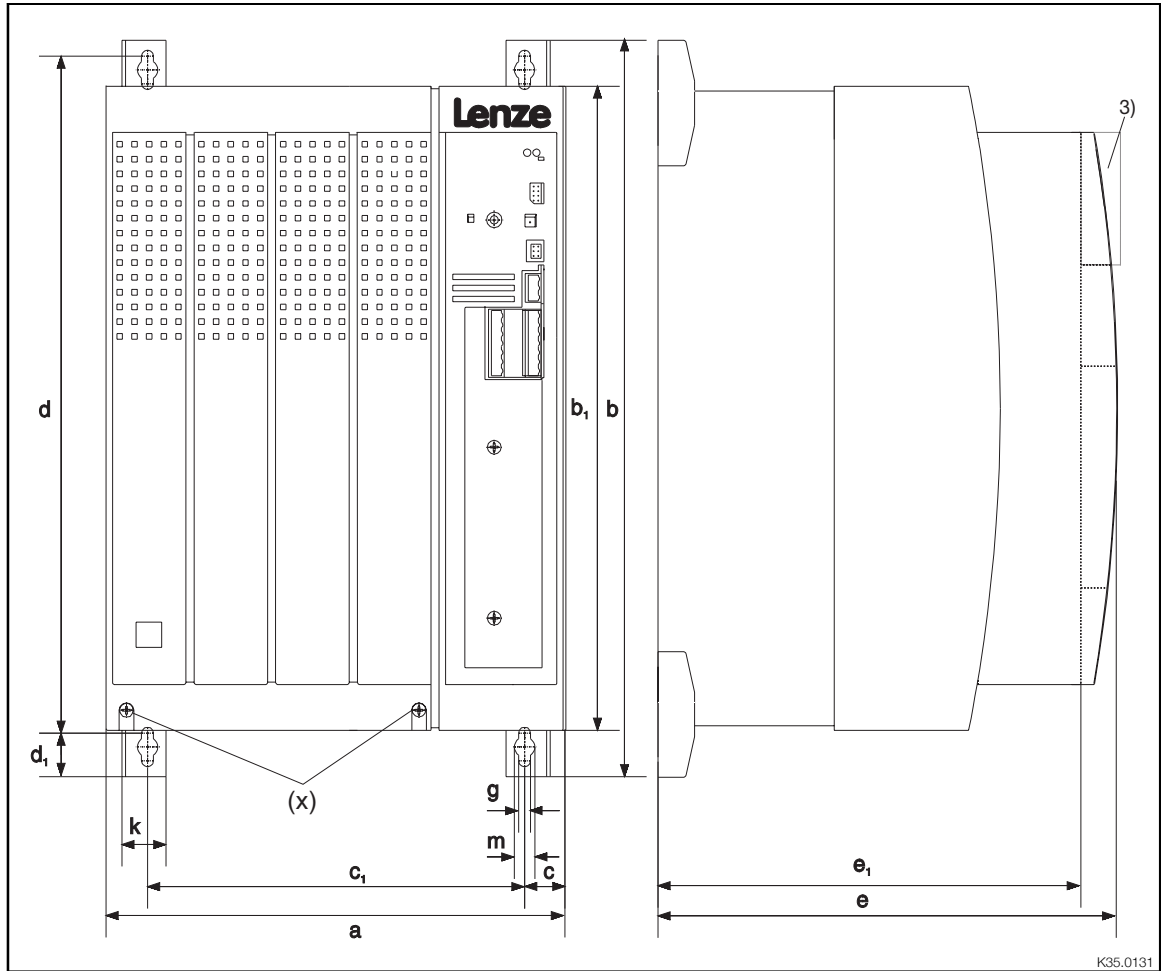
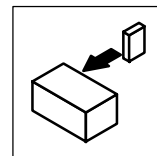

FIG 4-1 Dimensions - standard assembly

³⁾ With attachable fieldbus or I/O module:
Observe assembly depth and assembly space required for connection cables

[mm]	a	b	b1	c	c1	d	d1	e ³⁾	e1	g	k	m
8221 / 8222 / 8223	250	402	350	22	206	370	24	250	230	6.5	24	11
8224	340	580	510	28.5	283	532	38	285	265	11	24	18
8225	340	672	591	28.5	283	624	38	285	265	11	28	18
8226 / 8227	450	748.5	680	30.5	389	702	38	285	265	11	28	18
8241 / 8242	78	384	350	39	-	365	-	250	230	6.5	30	-
8243 / 8244	97	384	350	48.5	-	365	-	250	230	6.5	30	-
8245 / 8246	135	384	350	21.5	92	365	-	250	230	6.5	30	-



4.1.3 Assembly of analog plug-in module

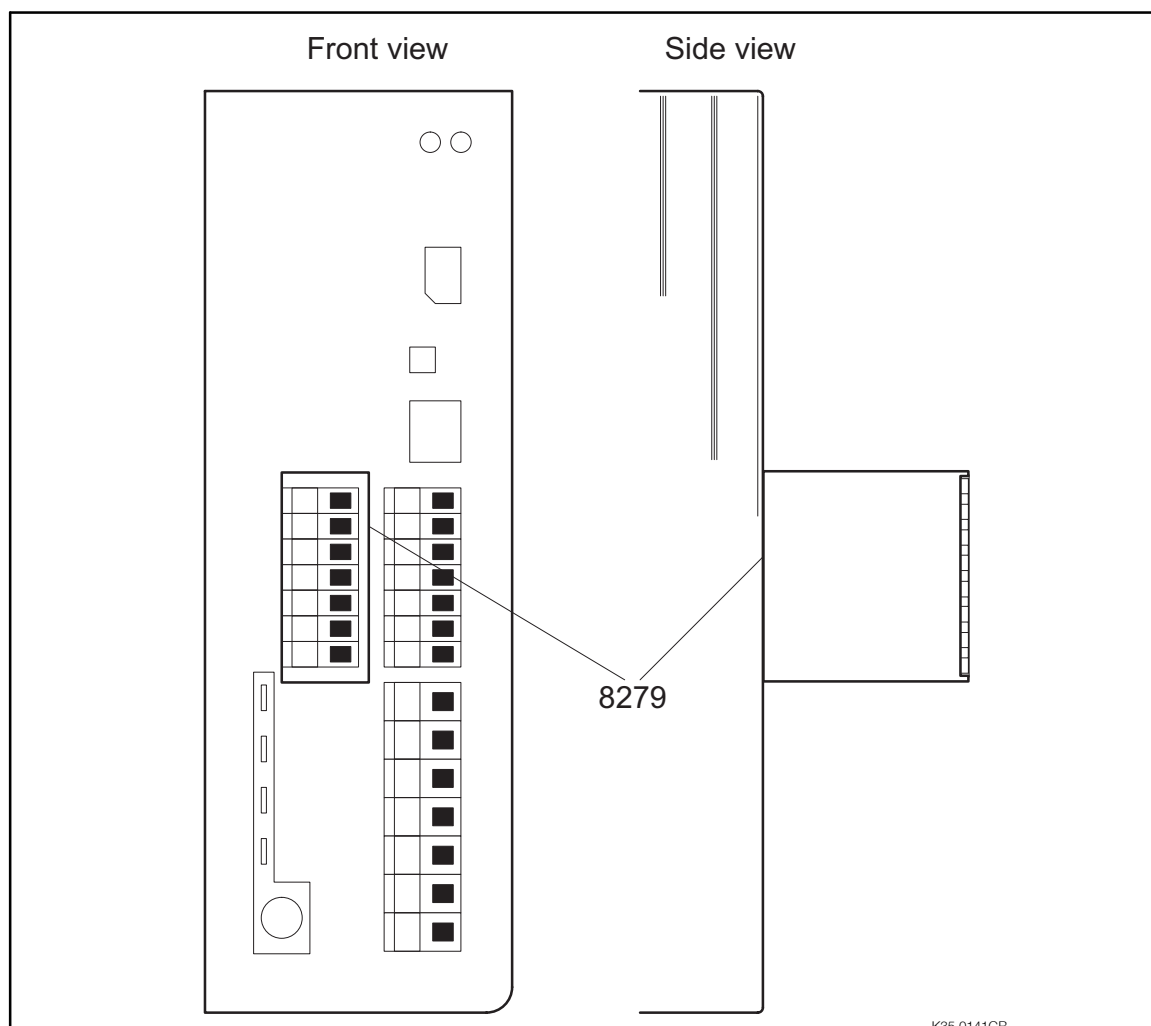
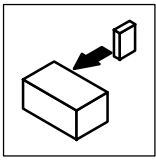

FIG 4-2 Analog plug-in module directly mounted onto the controller

Assembly

- The analog plug-in module is plugged onto the right terminal strip (terminals 20 ... 39).
- The unit requires 40 mm more assembly depth.

Step	What to do
1.	Remove the socket connector possibly attached to terminals 20 ... 39.
2.	Connect the analog plug-in terminal to the terminals 20 ... 39.
3.	Plug the socket connector in the terminals strip of the analog plug-in module (the plug-in modules serves as intermediate adapter).
4.	Connect the analog input to the terminals E1 and 39 of the socket connector.



Installation

4.2 Electrical installation

4.2.1 Important notes

- Please observe the tripping characteristic of the e.R.c.b, if applied.
- Ensure appropriate activation when using current-operated e.l.c.bs.
- For information on the installation according to EMC see chapter 4.3.
- Prior to assembly and service operations, the personnel must be free of electrostatic charge.
- Unused control inputs and outputs should be covered with plugs.
- In case of condensation, connect the controller to the mains voltage only after the visible humidity has evaporated.
- Please observe the restrictions of each mains type!

Mains	Operation of the controller	Notes
With grounded neutral	No restrictions	Observe controller ratings
With isolated neutral (IT mains)	Operation with recommended mains filters is not possible	<ul style="list-style-type: none"> • Mains filter will be destroyed if "earth fault" occurs. • Contact Lenze.
With grounded phase	Operation only possible with one variant	Contact Lenze
DC supply via $+U_e/-U_e$	DC voltage must be symmetrical to PE	Controller will be destroyed when grounding $+U_e$ conductor or $-U_e$ conductor.

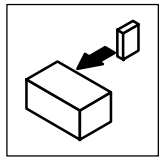

4.2.2 Power connections

4.2.2.1 Mains connection

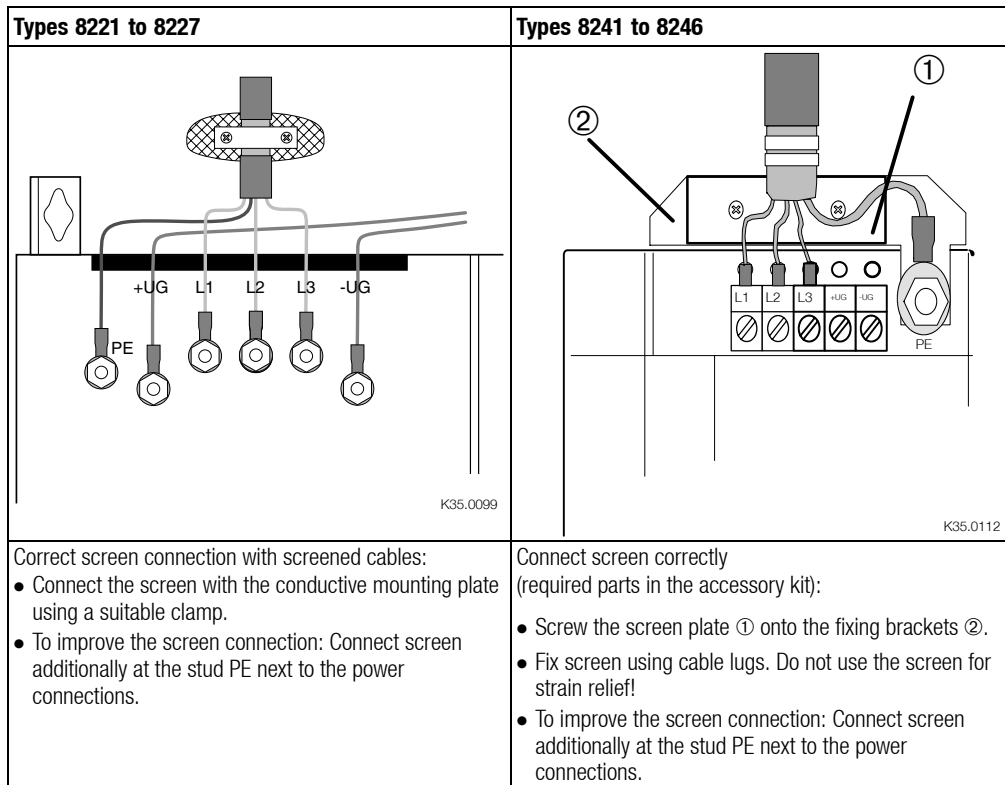
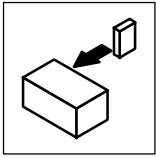

FIG 4-3 Proposal for mains connection 822X/824X

- Connect the mains cables with the screw terminals L1, L2, L3.
- Tightening torques

Type	Terminals	
	L1, L2, L3, +UG, -UG	PE connection
8221 - 8223	4 Nm (35 lbin)	
8224 - 8225	7 Nm (62 lbin)	
8226 - 8227	12 Nm (106.2 lbin)	
8241 - 8246	0.5 ... 0.6 Nm (4.4 ... 5.3 lbin)	3.4 Nm (30 lbin)



Installation

4.2.2.2 Motor connection

Because of the EMC safety we recommend the use of screened motor cables only.

<p>Types 8221/8222/8223</p> <p style="text-align: right;">K35.0081</p>	<p>Correct screen connection with screened cables:</p> <ul style="list-style-type: none"> • Fix the screen of the motor cables and, if necessary, thermal contacts by means of butt joints. Do not use the screen for strain relief! • To improve the screen connection: Connect screens additionally at the stud PE next to the motor connections.
<p>Types 8224/8225</p> <p style="text-align: right;">K35.0.0138</p>	<ul style="list-style-type: none"> • Strain relief by using cable binders ①. • Correct screen connection with screened cables: <ul style="list-style-type: none"> - Connect the screen of the motor cables to the screen sheet using a cable clamp and screws M5 x 12 ②. - Connect the screen of the thermal at the stud PE next to the motor connections with a surface as large as possible.
<p>Types 8226/8227</p> <p style="text-align: right;">K35.0139</p>	<ul style="list-style-type: none"> • Strain relief by using cable clamps and screws M4 x 12 ③. <ul style="list-style-type: none"> - Additional strain relief/fixing can be achieved by using cable binders ①. • Correct screen connection with screened cables: <ul style="list-style-type: none"> - Connect the screen of the motor cables to the screen sheet using a cable clamp and screws M5 x 12 ②. - Connect the screen of the thermal at the stud PE next to the motor connections with a surface as large as possible.

FIG 4-4 Proposal for the motor connection with 822X

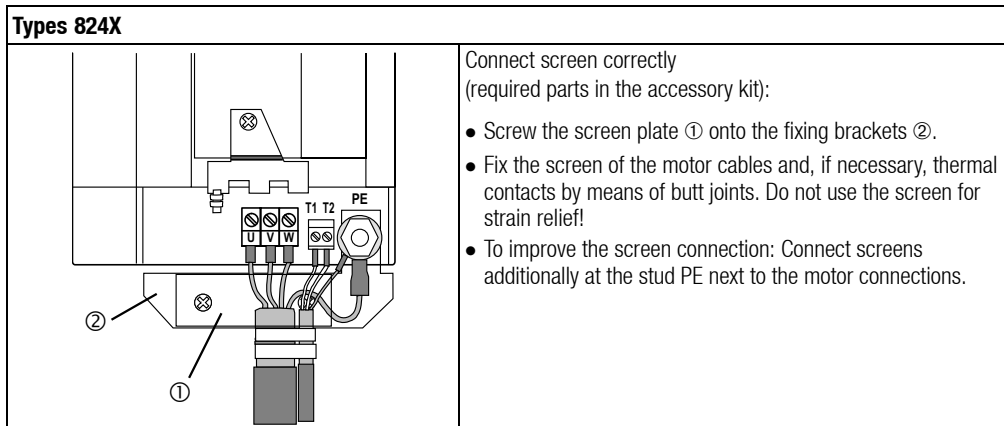
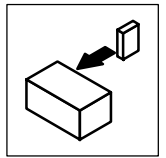
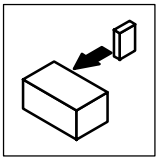

FIG 4-5 Proposal for the motor connection with 824X

- Connect the motor cables to the screw terminals U, V, W.
 - Observe correct pole connection.
 - Tightening torques

Type	Terminals			
	U, V, W	PE connection	Screen/ strain relief	T1, T2
8221 - 8223	4 Nm (35 lbin)		-	0.5 ... 0.6 Nm (4.4 ... 5.3 lbin)
8224 - 8225	7 Nm (62 lbin)		3.4 Nm (30 lbin)	0.5 ... 0.6 Nm (4.4 ... 5.3 lbin)
8226 - 8227	12 Nm (106.2 lbin)		M4: 1.7 Nm (15 lbin) M5: 3.4 Nm (30 lbin)	0.5 ... 0.6 Nm (4.4 ... 5.3 lbin)
8241 - 8246	0.5 ... 0.6 Nm (4.4 ... 5.3 lbin)	3.4 Nm (30 lbin)	-	0.5 ... 0.6 Nm (4.4 ... 5.3 lbin)

- Switching on the motor side of the controller is permitted
 - for safety switch off (emergency switch off).
 - during operation under load.



Installation

- The motor cable should be as short as possible because of the positive effect on the drive characteristic.
 - The table (see below) shows the relation between the motor cable length and the possibly required output filters.
 - For group drives (several motors connected to one controller) it is necessary to calculate the resulting cable length l_{res} :

$$l_{res} = \text{Sum of all motor cable lengths} \cdot \sqrt{\text{No. of motor cables}}$$

- The components stated in the table (see below) are valid for chopper frequencies ≤ 8 kHz (C018 = -0-, -1-). When using controllers with chopper frequencies > 8 kHz, different measures may be required. Please contact Lenze.
- When using unshielded motor cables, the data indicated in the table (see below) are valid for double motor cable lengths.
- Please contact Lenze when the absolute or resulting motor-cable lengths are > 200 m.

Type	Output filters additionally required in the motor cable			
	0	50m	100m	200m
8221/8222	None	Motor filter/motor choke	motor choke (Contact Lenze)	
8223/8224/8225 8226/8227		None		
8241/8242/8243 8244/8245/8246		Motor filter/motor choke	Sine filter	

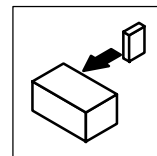

4.2.2.3 Connection diagram

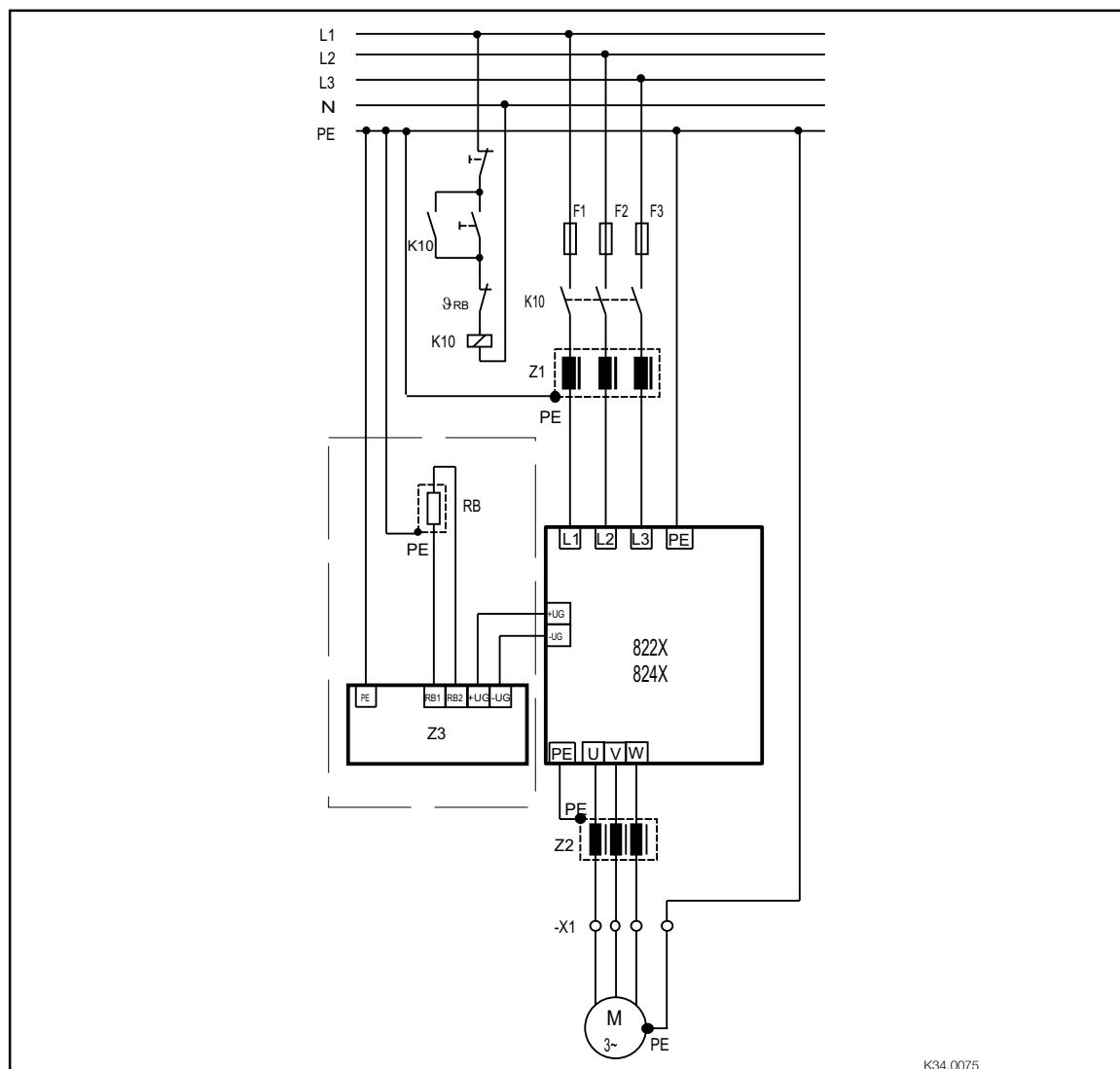

FIG 4-6 822X/824X power connections

F1, F2, F3 Fuses

K10 Mains contactor

Z1 Mains choke/mains filter, see Accessoires

Types 8222-8227, 8244/8246 - operation only with assigned mains choke/mains filter

Z2 Motor filter/sine filter, see Accessoires

Z3 Brake chopper/brake module, see Accessoires

RB Brake resistor, see Accessoires

Θ_{RB} Temperature monitoring - brake resistor

X1 Terminal strip in control cabinet

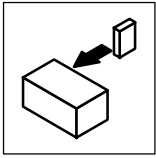

Installation

4.2.3 Control connections

4.2.3.1 Control cables

- We recommend the unilateral screening of all cables for analog signals to avoid signal distortion.
- Connect the screens of the control cables as follows:

- 822X, 824X
With the collective screen sheet on the front metal surface (screw length max. 12 mm).

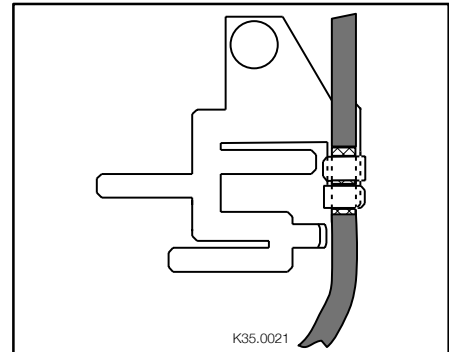

- If the control cables are interrupted (terminal strips, relays), the screens must be reconnected over the shortest possible distance.
- Connect the fixing screw of the setpoint potentiometer to PE.
- If possible, separate the monitoring cables from the motor cable.

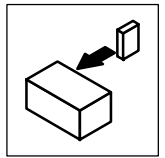

4.2.3.2 Assignment of the control terminals

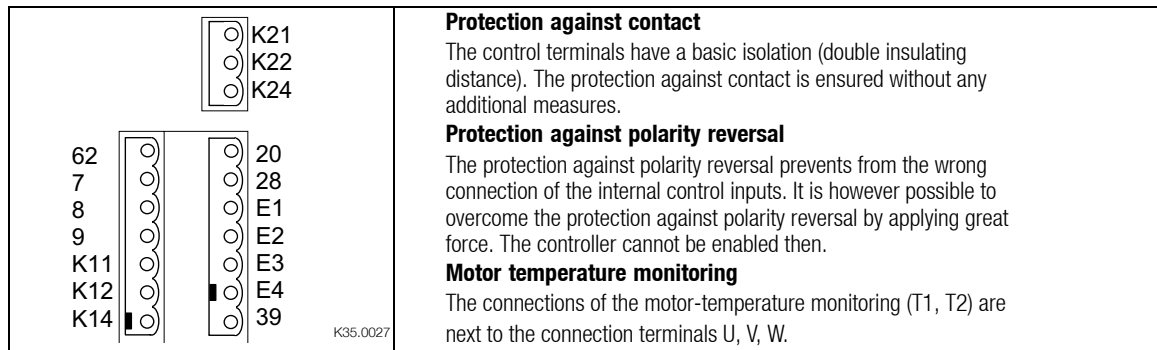
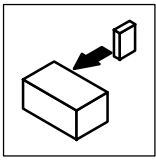

FIG 4-7 Position of the control terminals

	Terminal	Use (Factory setting is printed in bold)	Level	Data	
Analog inputs	7	GND 1			
	8	Setpoint input, reference: Terminal 7 (0 to 10V)		5 - 6 0 to 20 mA 5 - 6 4 to 20 mA 3 - 4 0 to 5 V 1 - 2 0 to 10 V	Resolution: 10 bit Linearity error: ±0.5 % Temperature fault: 0.3 % (0...+40 °C) Input resistance Voltage signal: > 100 kΩ Current signal: 250 Ω
	9	Supply for setpoint potentiometer	5.2V / 6mA		
Analog output	62	Analog output, reference: terminal 7 0 ... 6V (changes possible under C108)	0... 10 V / 2 mA	Resolution: 10 bit	
Digital inputs	20	Voltage supply for digital inputs 15 V/20 mA			
	28	Controller enable	HIGH	HIGH: 12 V ... 30 V	
	E4	CW rotation/ CCW rotation (CW/CCW)	CW: LOW CCW: HIGH	LOW: 0 V ... 3 V	
	E3	DC-injection brake	HIGH		
	E2	JOG frequencies	Binary code		
	E1	20Hz, 30Hz, 40Hz			
	39	GND 2 (reference for external voltages)			
Monitoring	T1	Motore-temperature monitoring (PTC thermistor/thermal contact)		If not used: set parameter C119 = -0!	
	T2	Motore-temperature monitoring (PTC thermistor/thermal contact)			

	Terminal	Use (Factory setting is printed in bold)	Relay position (switched)	Data
Relay output K1	K 11	Relay output normally-closed contact (TRIP)	opened	24 V AC / 3,0 A or 60 V DC / 0.5 A
	K 12	Relay mid-position contact		
	K 14	Relay output normally-open contact (TRIP)	closed	
Relay output K2	K 21	Relay output normally-closed contact (Ready for operation)	opened	250 V AC / 3,0A or 60 V DC / 0.5A
	K 22	Relay mid-position contact		
	K 24	Relay output normally-open contact (Ready for operation)	closed	



Installation

4.2.3.3 Connection diagrams

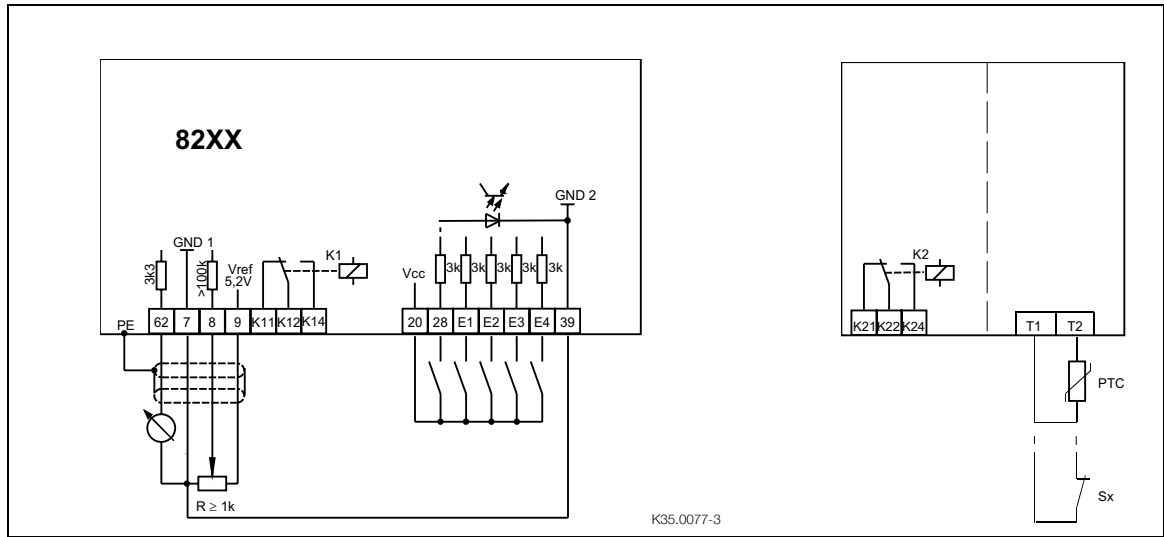

FIG 4-8 Control connections: Supply with internal control voltage

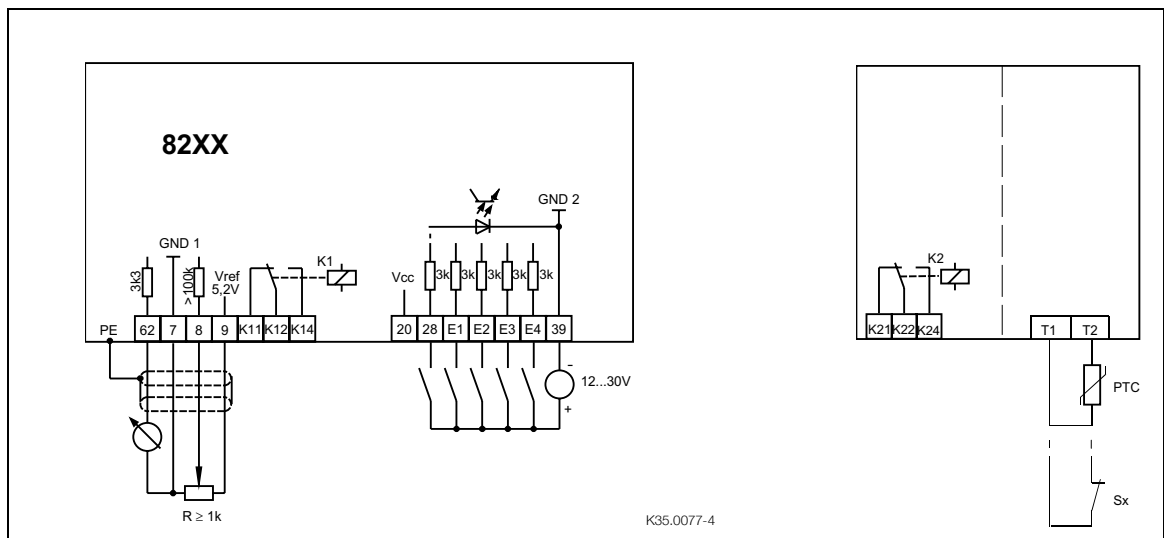
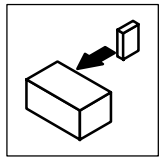

FIG 4-9 Control connections: External voltage supply (+12 V ... +30 V)

- GND1 Reference for internal voltages
- GND2 Reference for external voltages
- GND1 and GND2 have a potential isolation inside the unit.



4.2.3.4 Connection diagrams of analog plug-in modules

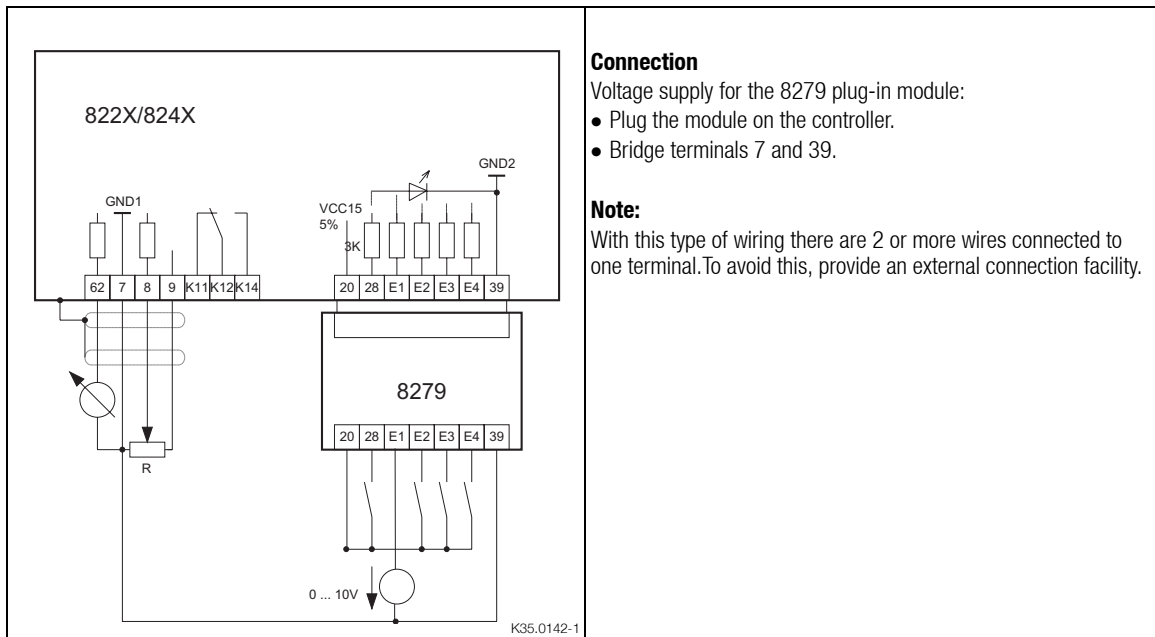

FIG 4-10 Control connections: Supply with internal control voltage

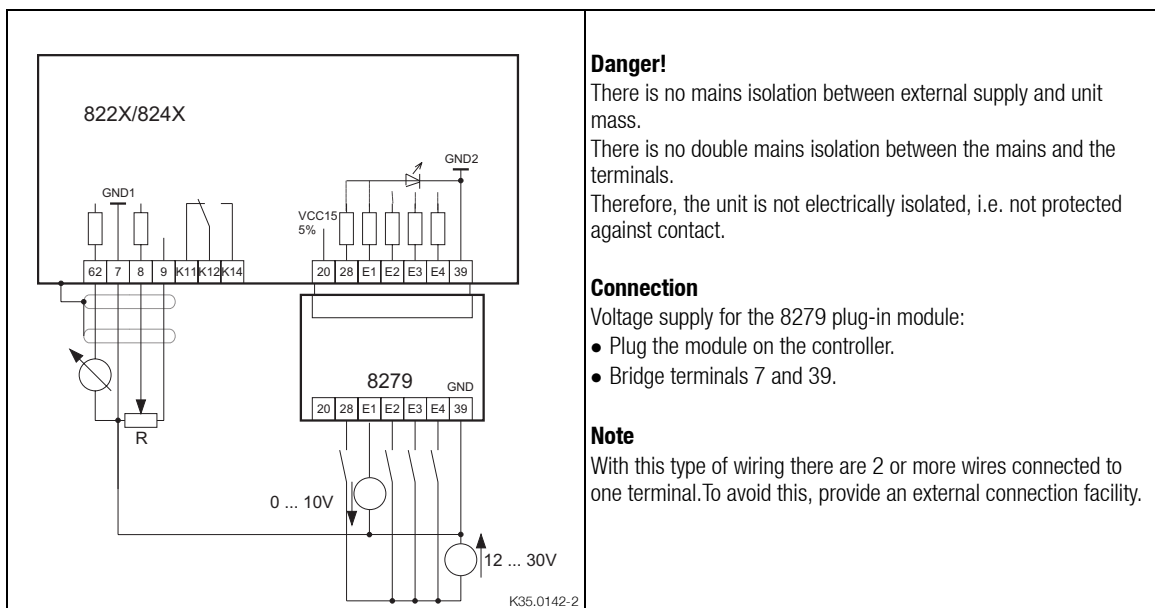
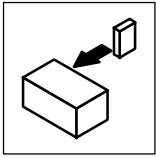

FIG 4-11 Control connections: Supply with external control voltage (+12 ... +30 V)

- GND1 Reference for internal voltages
- GND2 Reference for external voltages
- GND1 and GND2 have a potential isolation inside the unit.



Installation

4.3 Installation of a CE-typical drive system

General notes	<ul style="list-style-type: none"> - If you observe the following measure you can be sure that the drive system will not cause any EMC problems, i.e. comply with the EMC Directive when running the machine. - If devices which do not comply with the CE requirement concerning noise immunity EN 50082-2 are operated close to the controller, these devices may be interfered electromagnetically by the controllers.
Assembly	<ul style="list-style-type: none"> • Connect controller, mains choke, and mains filter to the grounded mounting plate with a wire of large a cross-section as possible: <ul style="list-style-type: none"> - Mounting plates with conductive surfaces (zinc-coated, stainless steel) allow permanent contact. - Varnished boards should not be used for installation in accordance with EMC • If you use several mounting plates: <ul style="list-style-type: none"> - Connect as much surface as possible of the mounting plates (e.g. with copper bands). • Ensure the separation of motor cable and signal or mains cable. • Do not use the same terminal strip for mains input and motor output. • Cable guides as close as possible to the reference potential. Unguided cables have the same effect as aerials.
Filters	<ul style="list-style-type: none"> • Use mains filters or RFI filters and mains chokes which are assigned to the controller: <ul style="list-style-type: none"> - RFI filters reduce impermissible high-frequency interference to a permissible value. - Mains chokes reduce low-frequency interferences which depend on the motor cable and its length. - Mains filters combine the functions of mains choke and RFI filter.
Shielding	<ul style="list-style-type: none"> • Connect the screen of the motor cable with the controller <ul style="list-style-type: none"> - to the screen connection of the controller. - additionally to the mounting plate with a surface as large as possible. - Recommendation: For the connection, use ground clamps on bare metal mounting surfaces. • If contactors, motor-protecting switches or terminals are located in the motor cable: <ul style="list-style-type: none"> - Connect the screens of the connected cables also to the mounting plate, with a surface as large as possible. • Connect the screen to PE, with a surface as large as possible. <ul style="list-style-type: none"> - Metal glands at the motor terminal box ensure a connection of the screen and the motor housing. • If the mains cable between mains filter and controller is longer than 300 mm: <ul style="list-style-type: none"> - Screen mains cables. - Connect the screen of the mains cable directly to the inverter and to the mains filter and connect it to the mounting plate with as large a surface as possible. • Use of a brake chopper: <ul style="list-style-type: none"> - Connect the screen of the brake resistor cable directly to the mounting plate, at the brake chopper and the brake resistor with as large a surface as possible. - Connect the screen of the cable between controller and brake chopper directly to the mounting plate, at the inverter and the brake chopper with a surface as large as possible. • Screen the control cables: <ul style="list-style-type: none"> - Connect both screen ends of the digital control cables. - Connect one screen end of the analog control cables. - Always connect the screens to the screen connection at the controller over the shortest possible distance. • Application of the controllers 821X/822X/824X in residential areas: <ul style="list-style-type: none"> - Use an additional screen damping ≥ 10 dB to limit the radio interference. This is usually achieved by installation in enclosed and grounded control cabinets made of metal.
Grounding	<ul style="list-style-type: none"> • Ground all metallically conductive components (controller, mains filter, motor filter, mains choke) using suitable cables connected to a central point (PE bar). • Maintain the minimum cross-sections prescribed in the safety regulations: <ul style="list-style-type: none"> - For EMC, not the cable cross-section is important, but the surface and the contact with a cross-section as large as possible, i.e. large surface.

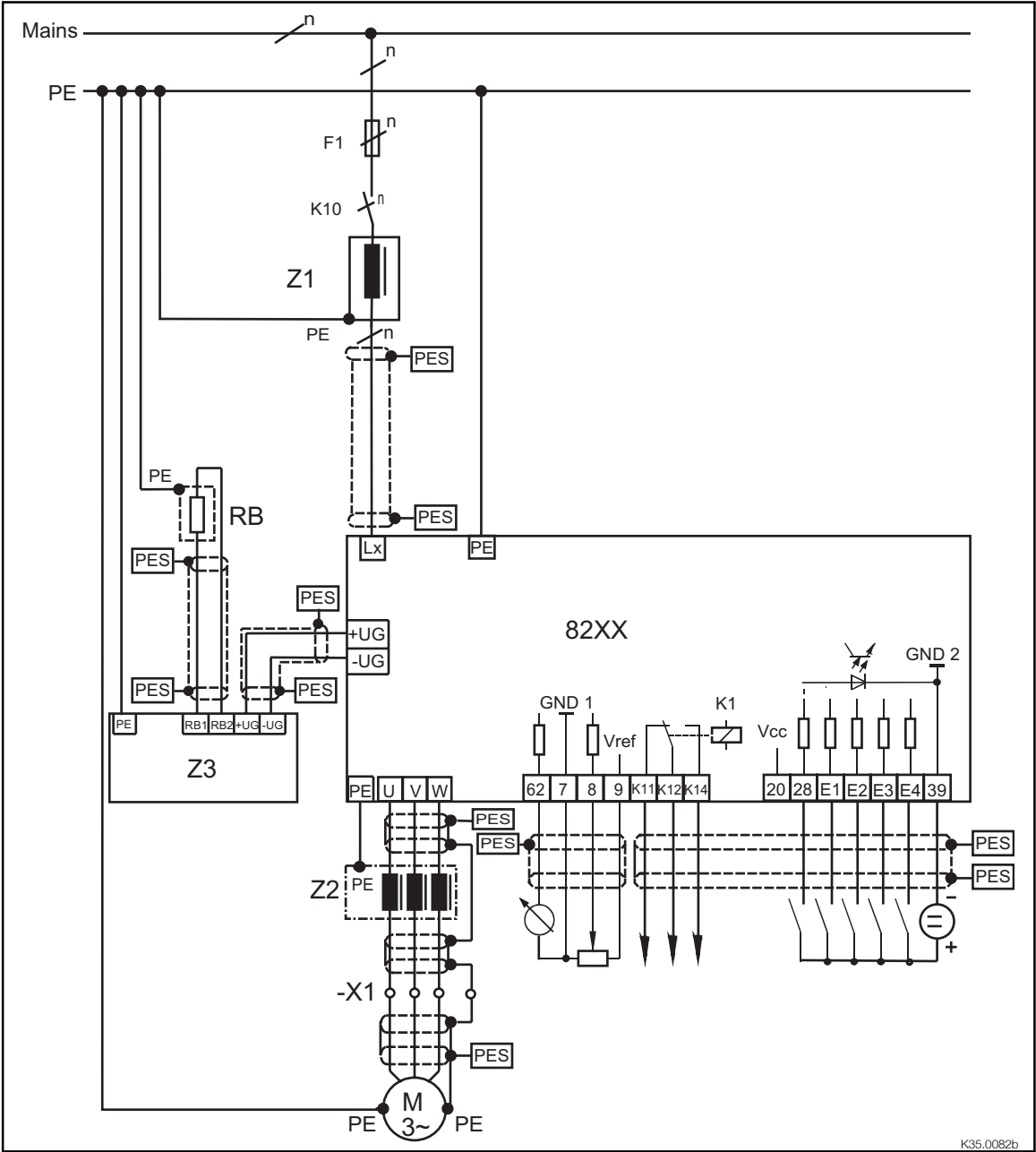
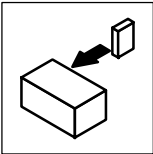
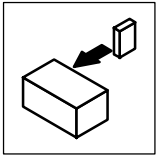
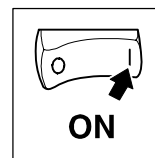

FIG 4-12 Example for an installation in accordance with the EMC regulations:

- F1 Fuse
- K10 Mains contactor
- Z1 Mains filter "A" or "B", see Accessories
- Z2 Motor filter/sine filter, see Accessories
- Z3 Brake module/brake chopper, see Accessories
- X1 Terminal strip in control cabinet
- RB Brake resistor
- PES HF screen because auf PE connection with a surface as large as possible (see chapter "Screening")
- n Number of phases



Installation



5 Commissioning

The controllers are factory-set to drive a corresponding four-pole standard asynchronous motor. Further settings are not necessary.

- 230/400 V, 50 Hz
- 265/460 V, 60 Hz
- 280/480 V, 60 Hz

Only a few settings via the 8201 BB operating module or a fieldbus module are necessary to adapt your drive to your application. The steps required are summarized in chapter 5.3 and in chapter 5.4.

5.1 Before you switch on

Prior to initial switch-on of the controller, check the wiring for completeness, short-circuit, and earth fault:

- Power connection:
 - Via L1, L2 and L3
 - Alternatively via terminals +UG, -UG (DC-group drive)
- Control terminals:
 - Reference potential for the control terminals is terminal 39.
 - Controller enable: terminal 28
 - Selection of direction of rotation: terminal E3 or E4
 - External setpoint selection: terminals 7, 8
 - Check jumper position! Factory setting: 0 - 10 V (see the table in chapter 4.2.3.2).
 - During operation with an internal voltage supply via terminal 20, bridge the terminals 7 and 39.
- In case of condensation connect the controller to mains voltage only after the visible humidity has evaporated.

Maintain the switch-on sequence!

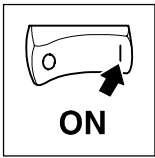

Commissioning

5.2 Short set-up (factory setting)

5.2.1 Switch-on sequence

Step	
1. Switch on mains voltage	
2. Select the direction of rotation.	<ul style="list-style-type: none"> • CW rotation: <ul style="list-style-type: none"> - Apply a LOW signal to terminal E4 (0...+3V). • CCW rotation: <ul style="list-style-type: none"> - Apply a HIGH signal to terminal E4 (+12...+30V).
3. Select the setpoint.	Apply a voltage 0...+10 V to terminal 8.
4. Enable the controller.	Apply a HIGH signal (+12...+30V) to terminal 28.
5. The drive is now operating according to factory setting.	

5.2.2 Factory setting of the most important drive parameters

Setting	Code	Factory setting	Adaption to the application
Operating mode	C001	-0- Setpoint selection via terminal 8 Control via terminals Parameter setting via 8201BB	See code table, chapter 7.2
Terminal configuration	C007	-0- E4 E3 E2 E1 CW/CCWDC brakeJOG1/2/3	See code table, chapter 7.2
Machine data			Chapter 5.3 ff.
Speed range	Min. field frequency	C010 0.00 Hz	Chapter 5.3.1
	Max. Field frequency	C011 50.00 Hz	
Acceleration and deceleration times	Acceleration time	C012 5.00 s	Chapter 5.3.2
	Deceleration time	C013 5.00 s	
Current limit values	Motor mode	C022 150 %	Chapter 5.3.3
	Generator mode	C023 80 %	
Drive performance			Chapter 5.4 ff.
Current, torque, power characteristic	Operating mode	C014 -4- Motor-current control	Motor-current control chapter 5.4.2.2 V/f characteristic control <ul style="list-style-type: none"> • with constant V_{min} boost, see chapter 5.4.2.1
	V/f rated frequency	C015 50.00 Hz	
	V_{min} setting	C016 0,00 %	
	Slip compensation	C021 0,0 %	

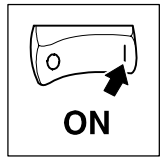

5.3 Adapt machine data

5.3.1 Determine speed range (f_{dmin} , f_{dmax})

Code	Name	Possible settings				IMPORTANT
		Lenze	Selection		Info	
C010	Minimum field frequency	0.00	0.00	{0.02Hz}	480.00	
C011	Maximum field frequency	50.00	7.50	{0.02Hz}	480.00	

Function

The speed range required for the application can be selected here by determining the field frequencies f_{dmin} and f_{dmax} :

- f_{dmin} corresponds to the speed at 0 % speed setpoint selection.
- f_{dmax} corresponds to the speed at 100 % speed setpoint selection.

Adjustment

Relation between field frequency and synchronous motor speed:

$$n_{rsyn} = \frac{f_{dmax} \cdot 60}{p}$$

n_{rsyn} synchronous motor speed [min^{-1}]

f_{dmax} Max. field frequency [Hz]

p Number of pole pairs

Example: 4 pole asynchronous motor:

$p = 2$, $f_{dmax} = 50 \text{ Hz}$

$$n_{rsyn} = \frac{50 \cdot 60}{2} = 1500 \text{ min}^{-1}$$

Important

- With the setting of $f_{dmin} > f_{dmax}$ the field frequency is limited to f_{dmax} .
- When selecting the setpoint by means of JOG values, f_{dmax} acts as limitation.
- f_{dmax} is an internal standardization variable:
 - Use the LECOM interface only for important modifications, when the controller is inhibited.
- Observe the maximum speed of the motor!
- f_{dmin} is only effective under the following conditions:
 - With analog setpoint selection.
 - With the motor potentiometer function "DOWN".

Special features

- With field frequencies $f_d > 300\text{Hz}$:
 - Avoid chopper frequencies $< 8 \text{ kHz}$.
- With C500 and C501, you can relate the display value of f_{dmin} and f_{dmax} to a process value.

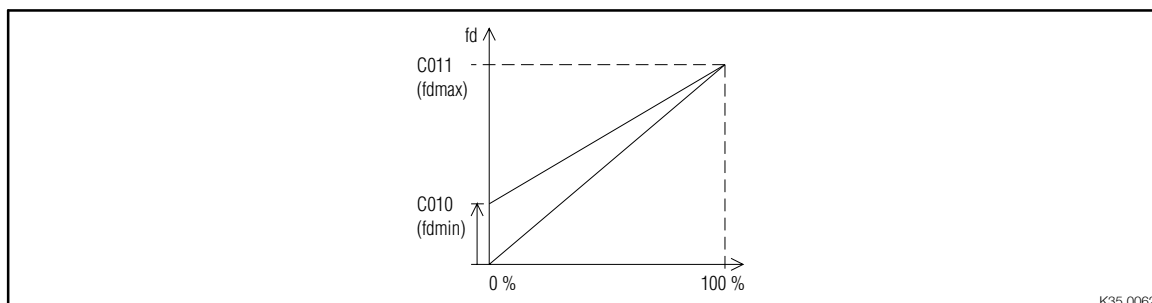

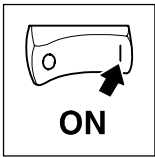

Commissioning

5.3.2 Adjustment of acceleration and deceleration times (T_{ir} , T_{if})

Code	Name	Possible settings				
		Lenze	Selection		Info	
C012	Acceleration time	5.00	0.00	{0.02s}	1300.00	T_{ir}
C013	Deceleration time	5.00	0.00	{0.02s}	1300.00	T_{if}

Function

The acceleration and deceleration times determine the time required by the drive to follow a setpoint change.

Adjustment

- The acceleration and deceleration times refer to a change of the field frequency from 0 Hz to the max. field frequency set under C011.
- Calculate the times T_{ir} and T_{if} , which must be set under C012 and C013.
 - t_{ir} and t_{if} are the times required for the change between f_{d1} and f_{d2} :

$$T_{ir} = t_{ir} \cdot \frac{f_{dmax}}{f_{d2} - f_{d1}} \qquad T_{if} = t_{if} \cdot \frac{f_{dmax}}{f_{d2} - f_{d1}}$$

Important

Under unfavourable operating conditions, too short acceleration and deceleration times can lead to the deactivation of the controller under overload with the indication of TRIP OC5. In these events, the acceleration and deceleration times should be set short enough so that the drive can follow the speed profile without reaching I_{max} of the controller.

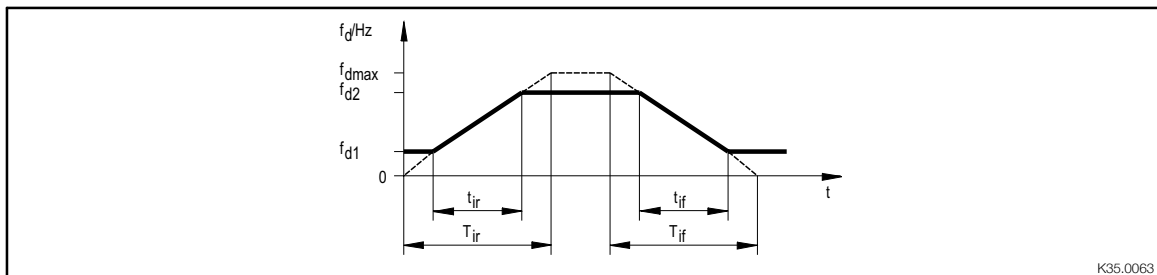

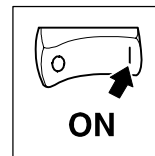

5.3.3 Setting of the current limit (I_{max})

Code	Name	Possible settings				IMPORTANT
		Lenze	Selection		Info	
C022	I_{max} limit motor mode	150	30	{1 %}	150	
C023	I_{max} limit generator mode	80	30	{1 %}	150	

Function The controllers are equipped with a current-limit control which determines the dynamic response under load. The measured load is compared with the limit values set under C022 for motor load and under C023 for generator load. If the current-limit values are exceeded, the controller will change its dynamic response.

Adjustment The acceleration and deceleration time should be set short enough so that the drive can follow the speed profile without reaching I_{max} of the controller.

Drive characteristic when reaching the limit value

- During acceleration:
 - Expansion of the acceleration ramp.
- During deceleration:
 - Expansion of the deceleration ramp.
- When the load increases at constant speed:
 - When the motor-current limit value is reached:
 - Reduction of the field frequency to 0.
 - When the generator-current limit value is reached:
 - Increase the field frequency to the maximum frequency (C011).
 - Stop the field-frequency change if the load falls below the limit value.

Important

- In the generator mode the current can only be controlled correctly when you connect a brake unit or in group drive with energy exchange.
- For operation with chopper frequencies > 8 kHz, the current limit values should be set to the currents " I_{max} for 60 s" indicated in the rated data (see chapter 3.3). (Derating with higher chopper frequencies)

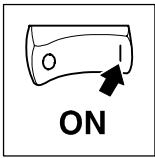

Commissioning

5.4 Optimisation of the operating characteristic of the drive

By means of the following settings you can influence the current, torque and power characteristic or the connected motor.

You can choose between the control modes "motor-current control" and "V/f-characteristic control". In chapter 5.4.1 you will find some more information to help you with the selection.

5.4.1 Select the control mode

Code	Name	Possible settings		
		Lenze	Selection	Info
C014 ↓	Operating mode	-4-	-2- Linear characteristic $V \sim f_d$ with constant V_{min} boost. -3- Square characteristic $V \sim f_d^2$ with constant V_{min} boost -4- Motor-current control	Control modes of the voltage characteristic

Function

- Under C014 you can set the control mode and the voltage characteristic.
- The V/f-characteristic control with auto boost enables a low-loss operation of single drives with standard three-phase AC motors with load-dependent V_{min} boost.
- The motor-current control enables a "Sensorless Speed Control". Compared with the V/f characteristic control, the drive can operate with a considerable higher torque and consumes less current during idle running.

C014 = -2-
Linear characteristic

C014 = -3-
Square-law characteristic (e. g. for pumps, fans)

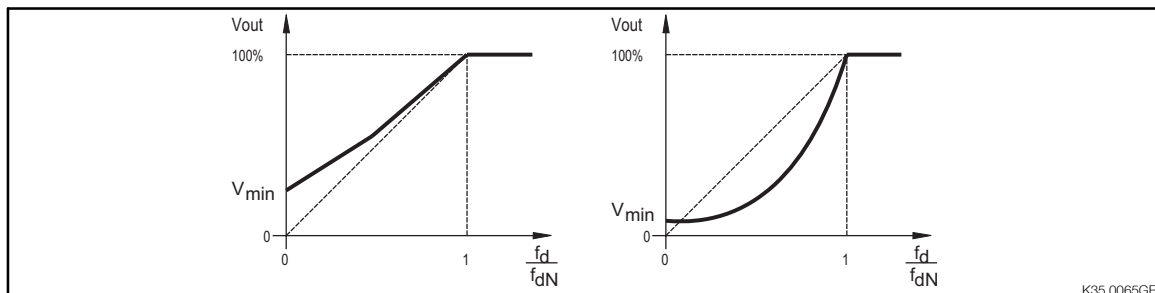

K35.0065GB

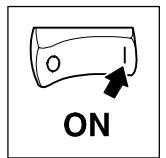

Help for decision	Motor cable			
	screened ≤ 50 m unscreened ≤ 100 m		screened > 50 m unscreened > 100 m	
	C014			
Single drives	recommended	alternatively	recommended	alternatively
With constant load	-4-	-2-	-2-	-
With changing loads	-4-	-2-	-2-	-
With heavy start conditions	-4-	-2-	-2-	-
High-dynamic positioning and feed drives	-2-	-	-2-	-
Lifts and hoists	-4-	-2-/-4-	-2-	-
Pumps and fan drives	-3-	-2-	-3-	-2-
Three-phase reluctance motors	-2-	-	-2-	-
Three-phase sliding rotor motors	-2-	-	-2-	-
Three phase motors with assigned frequency-voltage characteristic	-2-	-	-2-	-
Group drives (depending on the resulting motor-cable length)	$I_{res} = \sqrt{i} \cdot (I_1 + I_2 + \dots + I_n)$			
same motors and loads	-4-	-2-	-2-	-
different motors and/or changing loads	-2-	-	-2-	-

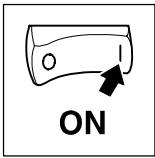

Commissioning

5.4.2 Optimisation of operating modes

5.4.2.1 Optimisation of V/f characteristic control with constant V_{min} boost

Codes required

Code	Name	Possible settings			IMPORTANT
		Lenze	Selection	Info	
C015	V/f rated frequency	50.00	7.50 {0.02Hz}	960.00	
C016	V_{min} setting	0.00	0.00 {0.02 %}	40.00	
C021	Slip compensation	0.0	-50.0 {0.1 %}	50.0	

Adjustment

- If necessary, select V/f characteristic (C014).
- Select V/f-rated frequency (C015).

- The V/f-rated frequency determines the slope of the V/f characteristic and has considerable influence on the current, torque and power performance of the motor.
- An internal mains voltage compensation compensates deviations in the mains during operation. They therefore do not have to be considered for the setting of C015.

Adjustment

Calculate the frequency to be set under C105:

$$C015[\text{Hz}] = \frac{400\text{V}}{V_{\text{rated motor}}[\text{V}]} \cdot \text{Rated motor frequency} [\text{Hz}]$$

C014 = -2-
Linear characteristic

C014 = -3-
Square-law characteristic (e. g. for pumps, fans)

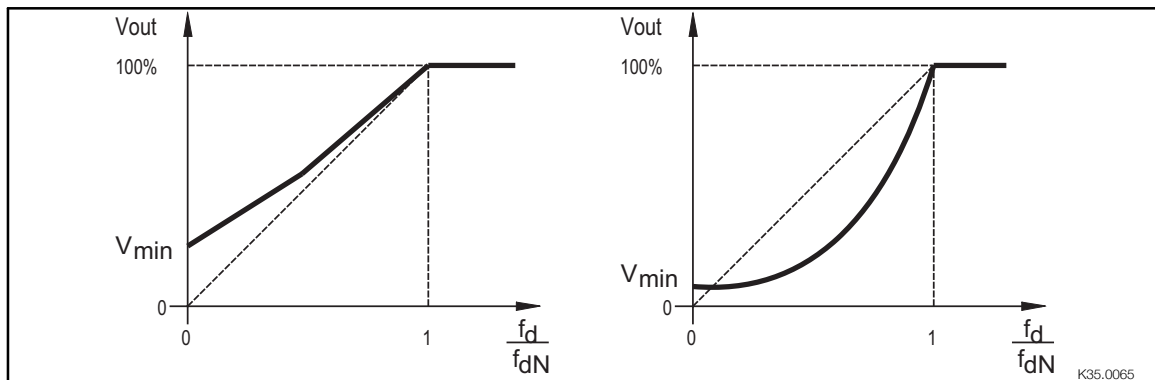

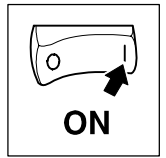

3. Set the V_{min} boost (C016).

- **Load independent** boost of the motor voltage for field frequencies below the rated V/f frequency. You can thus optimize the torque performance of the inverter drive.
- It is absolutely necessary to adapt the asynchronous motor used, since otherwise, the motor can be destroyed by overtemperature:

Adjustment

Please note the thermal characteristic of the connected motor under small field frequencies:

- Usually, standard asynchronous motors with insulation class B can be operated for a short time with rated current and frequencies between $0\text{Hz} \leq f_d \leq 25\text{Hz}$.
- Please ask the motor manufacturer for the exact setting values for the motor current.

A Operate the motor when no load is applied with a slip frequency of $f_d \approx$:

- $P_{Mot} \leq 7,5\text{ kW}$: $f_d \approx 5\text{ Hz}$
- $P_{Mot} > 7,5\text{ kW}$: $f_d \approx 2\text{ Hz}$

B Increase V_{min} until you reach the following motor current:

- **Motor in short-term operation** at $0\text{Hz} \leq f_d \leq 25\text{Hz}$:
with self-ventilated motors: $I_{motor} \leq 0,8 \cdot I_{rated\ motor}$
with forced ventilated motors: $I_{motor} \leq I_{rated\ motor}$
- **Motor in permanent operation** at $0\text{Hz} \leq f_d \leq 25\text{Hz}$:
with self-ventilated motors: $I_{motor} \leq 0,8 \cdot I_{rated\ motor}$
with forced ventilated motors: $I_{motor} \leq I_{rated\ motor}$

4. Set slip compensation (C021).

Rough setting by means of the motor data:

$$s = \frac{n_{rsyn} - n_r}{n_{rsyn}} \cdot 100\%$$

$$n_{rsyn} = \frac{f_{dr} \cdot 60}{p}$$

s	Slip constant (C021)
n_{rsyn}	synchronous motor speed [min^{-1}]
n_r	rated speed to motor nameplate [min^{-1}]
f_{dr}	rated frequency to motor nameplate [Hz]
p	Number of pole pairs

Precise setting:

Change C021 under constant load until the speed is near the synchronous speed.

If C021 is set to too high values, the drive may become unstable (overcompensation).

Important

The change from V/f-characteristic control to motor-current control should only be made when the controller is inhibited.

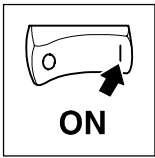

Commissioning

5.4.2.2 Optimisation of motor-current control

Codes required

Code	Name	Possible settings			IMPORTANT
		Lenze	Selection	Info	
C015	V/f rated frequency	50.00	7.50 {0.02Hz} 960.00		
C021	Slip compensation	0	-50.0 {0.1 %} 50.0		
C088	Rated motor current	*	0.0 ... 2.0 · rated output current	* depends on the unit	Input only necessary when motors not adapted.
C091	Motor cos φ	*	0.4 {0.1} 1.0		

Setting sequence

- Drives with matching 4 pole standard motors 230/400 V in star connection do not need to be adapted. After having started the drive, the controller itself detects all further motor data.
- The following drives can be optimized by entering the nameplate data "rated motor current" and "cos φ" under C088 or C091:
 - Motor one power class smaller than the motor assigned to the controller.
 - Motor one or two power classes smaller than the motor assigned to the controller.
 - Drives with 2, 6, 8, 10 and 12 pole standard motors.
 - Drives with special motors.
- With the slip compensation C021, you can optimize the "sensorless speed control" for your application.

1. If necessary, select C014 = -4-

(factory setting)

2. Select V/f-rated frequency (C015).

Motor voltage	Motor connection	C015
220/380 V	Y	52,6 Hz
230/400 V, 265/460 V, 280/480 V	Y	50 Hz
220/380 V, 230/400 V, 265/460 V, 280/480 V	Δ	87 Hz
380/660 V	Δ	52,6 Hz
400/690 V	Δ	50 Hz

3. If necessary, enter the motor data of unadapted motors (C088, C091).

4. Set slip compensation (C021):

Rough setting by means of the motor data:

$$s = \frac{n_{rsyn} - n_r}{n_{rsyn}} \cdot 100\%$$

$$n_{rsyn} = \frac{f_{dr} \cdot 60}{p}$$

- s Slip constant (C021)
- n_{rsyn} synchronous motor speed [min^{-1}]
- n_r rated speed to motor nameplate [min^{-1}]
- f_{dr} rated frequency to motor nameplate [Hz]
- p Number of pole pairs

Precise setting:

Change C021 under constant load until the speed is near the synchronous speed. If C021 is set to too high values, the drive may become instable (overcompensation).

Important

- The change from V/f-characteristic control to motor-current control should only be carried out when the controller is inhibited.
- The idle current of the motor (magnetizing current) must not exceed the rated current of the controller.
- With very small friction values it is possible that an angle offset of up to 180° occurs when enabling the controller.

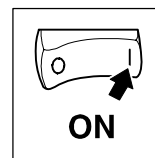

5.5 Operation with the PID-controller

The following controls can be implemented with the internal process controller:

- Pressure
- Temperature
- Flow
- Humidity
- Speed
- Dancer-position.

Settings

Configuration	Set C005 -6- or -7- for controlled operation with a PID controller.
Setpoint	The setpoint can be set via terminal 8 or terminal E1. The terminal not used for setpoint selection is used for the feedback.
Terminal E1	<ul style="list-style-type: none"> ● If you use the "analog plug-in module 8279" terminal E1 will be used as 2nd analog input (0 ... 10 V / 0/4 ... 20 mA). ● If you do not use the "analog plug-in module 8279", terminal E1 can be used as digital input. Pulse frequency 0 ... 10 kHz with level: 0 ... 3V = LOW 12... 30V = HIGH

The codes C070 to C072 are especially for parameter setting of the PID controller (see Code table).

In addition, the influence of the PID controller can be set under C074. Under C238 you can select whether you want a setpoint precontrol or not. This is very advantageous for applications in which the setpoint signal is directly proportional to the drive speed. Thus it is possible to limit the influence of the PID controller, such that only the maximum expectable slip of the machine will be compensated.

The actual value of the PID controller is displayed under C051. The PID controller setpoint is displayed in C046 or C049.

The control range can be limited by adjusting the analog inputs (C026, C027 for terminal 8; C426, C427 for term. E1 with plug-in module 8279).

This can be used, for instance in pressure controls, to determine the pressure setpoint.

The I-component of the controller can be reset when reading the Q_{min} threshold (C017) to suppress the initial conditions because of the missing actual value.

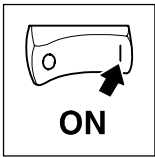

Commissioning

5.5.1 Standardisation of process value

821X/822X setting range/824X:

Code	Name	Possible settings			IMPORTANT
		Lenze	Selection	Info	
C500*	Display factor application datum numerator	2000	1 {1} 25000		
C501*	Display factor for process variable denominator	10	1 {1} 25000		

Function

Adaption of the field-frequency related parameters C010, C011, C017, C019, C037, C038, C039, C050, C051 and C181 to a process value to be controlled, e.g. pressure, temperature, flow rate, humidity or speed. By this, an absolute or relative display or selection of a process value can be implemented.

Adjustment

The display value CXXX is calculated from:

$$CXXX = \frac{C011}{200} \cdot \frac{C500}{C501}$$

Example

Relative or absolute selection and display of a speed setpoint
 $P_{soll} = 5 \text{ bar}$, $f_{dmax} = 50 \text{ Hz}$:

a) Relative standardisation in %

$$100,0 (\%) = \frac{50}{200} \cdot \frac{4000}{10}$$

(e. g. C500=4000; C501=10)

b) Absolute standardisation in physical units

$$5,00(\text{bar}) = \frac{50}{200} \cdot \frac{200}{10}$$

(e. g. C500=200; C501=10)

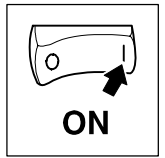

5.6 Application examples

5.6.1 Air conditioning

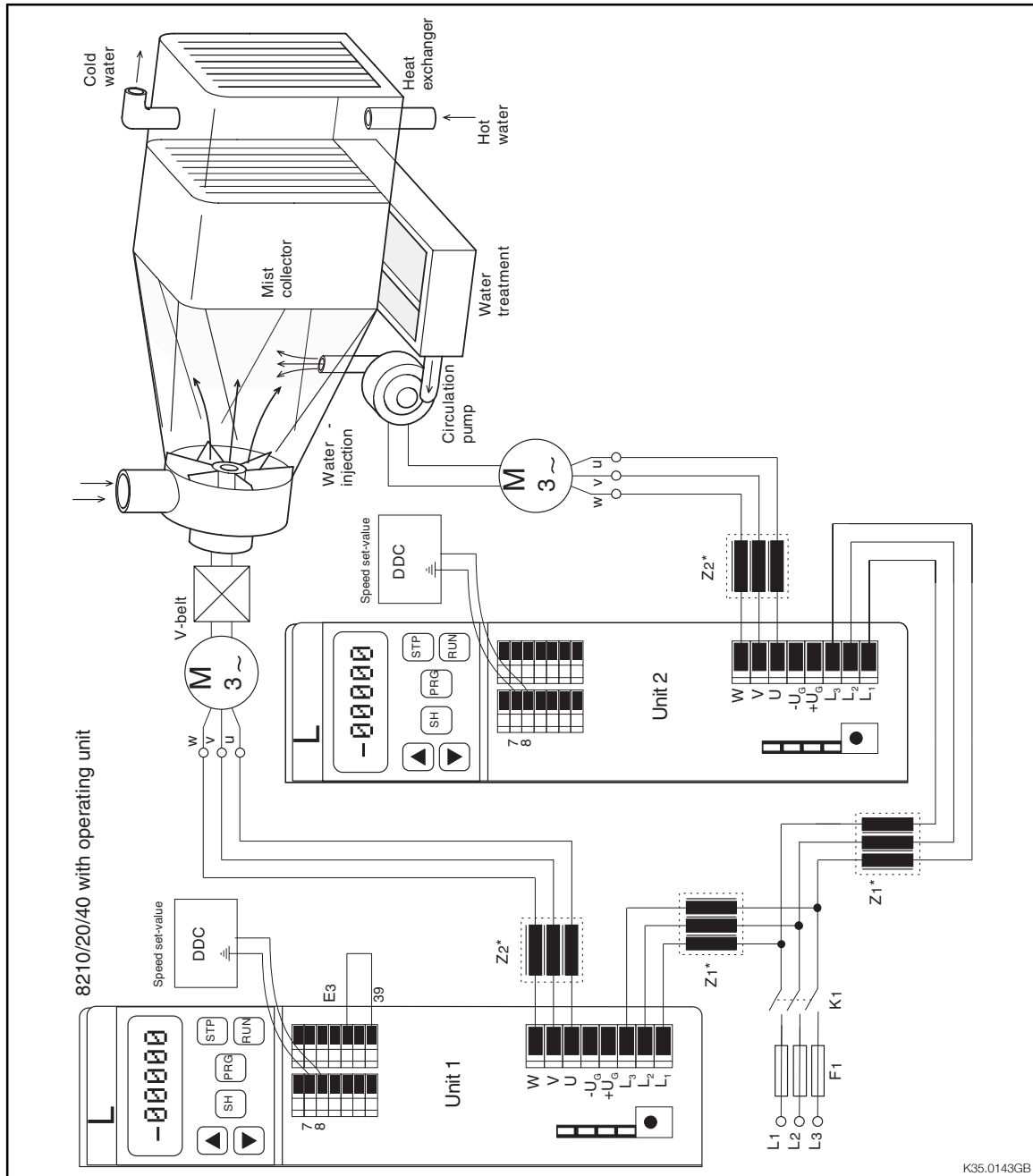
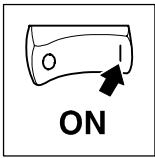

FIG 5-1 Application example of an air conditioning system

- * Z1 Mains filter required for radio interference level A or B.
- * Z2 Motor filter required for motor cables: screened as from 50 m, unscreened as from 100 m.
Sine filter required for motor cables: screened as from 100 m, unscreened as from 200 m.

Screen all signal and motor cables. Please observe the corresponding installation instruction in chapter 4.2 and 4.3.



Commissioning

Task (FIG 5-1):

The air condition of a department store is to be controlled according to the number of persons present. The fans must circulate an amount of air that corresponds to the number of people (data, for instance, provided by a person counting unit).

Functions used

- Belt monitoring
- Mains failure detection
 - Controlled deceleration and stopping of the drive after mains failure
- Flying restart circuit on coasting motor
- Removal of mechanical resonances
- Smooth start/stop with S ramps

Code settings - unit 1:

Code	Name	Possible settings (the parameters selected must be adapted to the machine data)	
		Lenze	Selection
C001 C2001	Operating mode	-0-	-0- Setpoint selection via term. 8 (jumper setting see chapter 4.2.3.2) Control via term. parameter setting with 8201BB
C005 C2005	Configuration	-0-	-0- Operation with open-loop control via terminal 8
C008 C2008	Function relay K1	-1-	-14- Apparent motor current (C054) < Current threshold C156 and acceleration finished (Belt monitoring)
C014 C2014	Operating mode	-0-	-3- Square characteristic $V \sim f_d^2$ with constant V_{min} boost
C142 C2142	Start condition	-1-	-3- Automatic start, if term. 28 HIGH, flying-restart circuit active
C156	Current threshold	0	50 %
C182	$t_{integration}$ RFG S shape	0.00	0.50 s Smooth start / stop
C625	Locked frequency 1	480.00	30.00Hz Removal of mechanical resonances
C628	Bandwidth of skip frequencies, f_{skip}	0.00	10.00 %
C988	DC-bus voltage threshold for DC-bus voltage control	0	81 % Controlled deceleration and stopping after mains failure by changing the parameter set

Motor deceleration after mains failure

Parameter set changeover by controlling the DC bus

PAR 1	PAR 2 (Code = C2XXX)
C007 = 2 C105 = 0.5 s	C2007 = 0 C2105 = 5.00 s

Note:

Terminal 3 must always have LOW level (PAR2: Normal operation; PAR1: QSP)

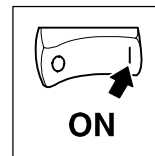

Code settings - unit 2:

Code	Name	Possible settings		
		Lenze	Selection	Info
C001	Operating mode	-0-	-0-	Setpoint selection via term. 8. Control via terminals. Parameter setting via 8201BB
C005	Configuration	-0-	-0-	Operation with open-loop control via terminal 8
C014	Operating mode	-0-	-3-	Square characteristic $V \sim f_d^2$ with constant V_{\min} boost

According to the information given in both tables (code setting for unit 1 and 2):

1. All other parameters are based on the factory setting.
2. Set the rated motor data (depends on the motor used) under C088 (rated motor current) and C091 (motor cos φ).

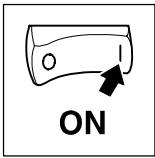

Commissioning

5.6.2 Pump application with pressure control

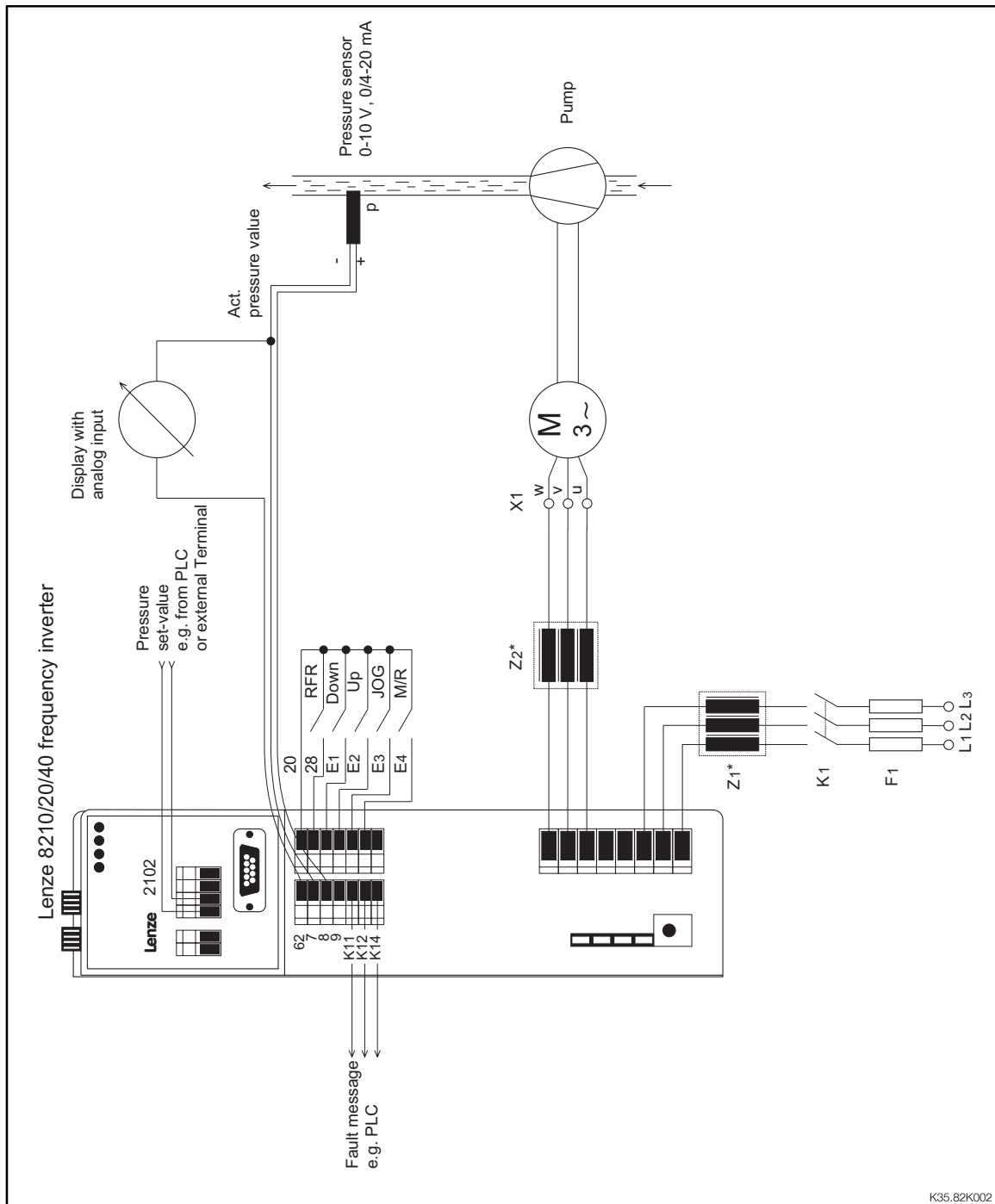
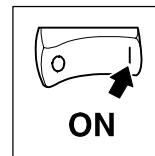

FIG 5-2 Application of a pump with pressure control

* Z1 Mains filter required for radio interference level A or B.
Mains choke see chapter 3 Rated Data

* Z2 Motor filter required for motor cables: screened as from 50 m, unscreened as from 100 m.
Sine filter required for motor cables: screened as from 100 m, unscreened as from 200 m.

Screen all signal and motor cables. Please observe the corresponding installation instruction in chapter 4.2 and 4.3.



Task (FIG 5-2):

A centrifugal pump is used to ensure constant pressure in a pipeline system (e.g. for water supply of residential and industrial premises).

The application does not only require remote control from a central operating panel but also setting possibilities at site. The pressure is to be reduced to a fixed value during times when only few water is required. By monitoring the actual pressure it is also possible to detect burst pipes.

Functions used

- Internal PID controller for pressure control.
 - Regular control, setpoint selection via fieldbus with feedback via analog channel terminal 8.
- Networking via fieldbus (e.g. plug-on module 2102).
- Manual / Remote changeover (M-/-R).
 - Change between setpoint selection via fieldbus and manual momentary-contact switch (terminal E1 = down, terminal E2 = up).
- Selection of a process set-value (e.g. pressure set-value) via JOG value of the inverter.
- Electrical controller inhibit.

Code settings:

Code	Name	Possible settings		IMPORTANT
		Lenze	Selection	
C001	Operating mode	-0-	-3- Setpoint selection (control, parameter setting) via LECOM	
C005	Configuration	-0-	-7- Operation with closed-loop control, with analog feedback via terminal 8	
C007	Terminal configuration	-0-	-26- Motor potentiometer (UP/DOWN), JOG1, M/R	
C037	JOG value 1	20.00	16.67Hz Fixed reduction to 1/3 of the rated pressure.	
C051	Actual PID controller value			Only display of act. pressure
C070	Gain PID controller	1.00	1.00	Adapt to process
C071	Integral action time PID controller	100	100 ms	Adapt to process
C072	Differential component PID controller	0.0	0.0	Adapt to process
C074	Influence PID controller	0.0	100%	
C238	Frequency precontrol	-1-	-0- No precontrol	

All other parameters are based on the factory setting.

Set the rated motor data (depends on the motor used) under C088 (rated motor current) and C091 (motor cos φ).

The pressure setpoint cannot only be selected via a fieldbus but also via the operating unit 8201BB (installation up to 10m distance possible) or an analog input signal (with module 8279).

For standardisation of the process value see chapter 5.5.1.

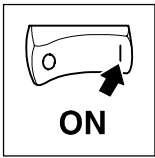

Commissioning

5.6.3 Pump application with level control

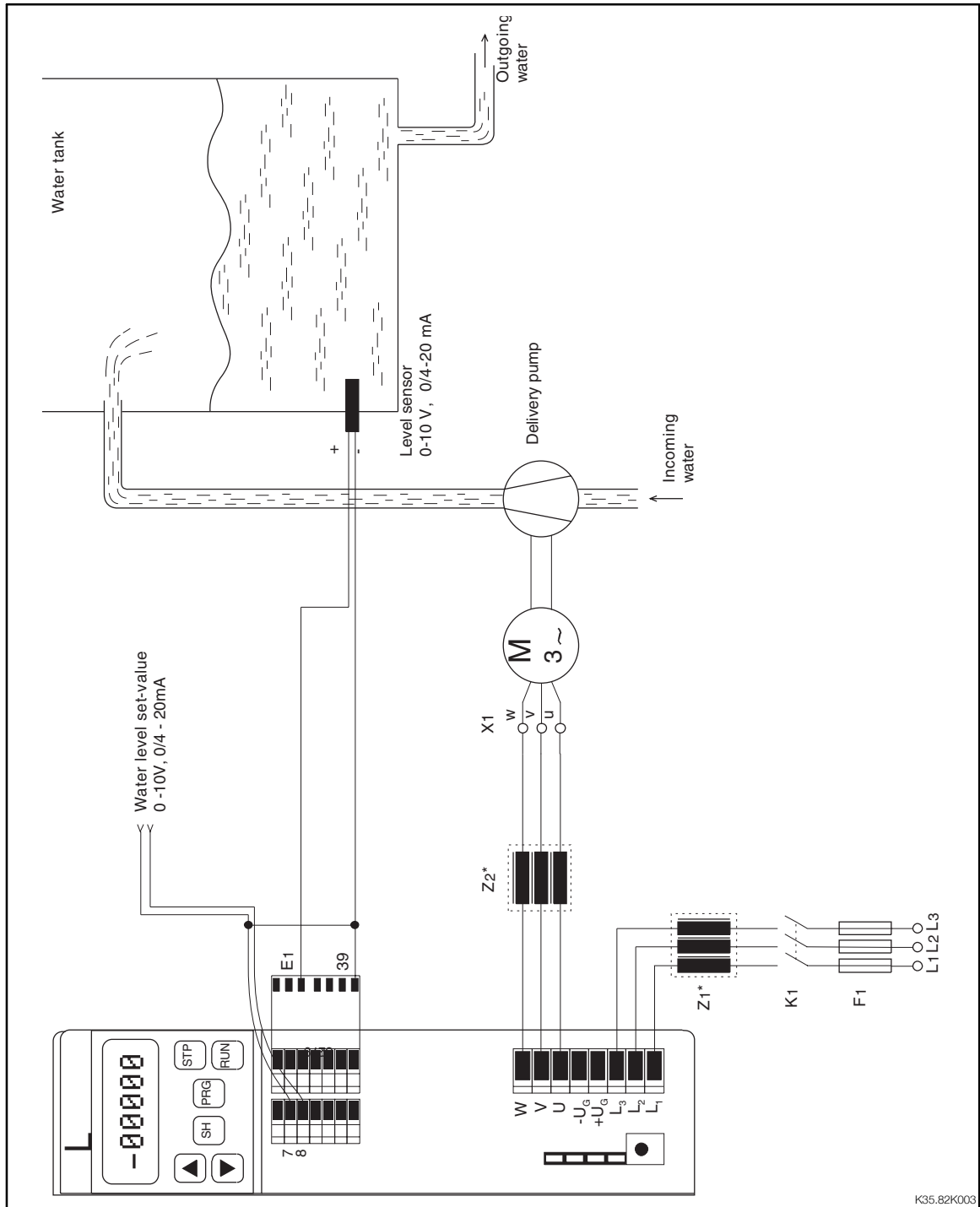
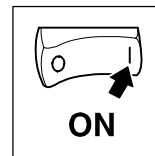

FIG 5-3 Application of a pump with level control

* Z1 Mains filter required for radio interference level A or B.

* Z2 Motor filter required for motor cables: screened as from 50 m, unscreened as from 100 m.
Sine filter required for motor cables: screened as from 100 m, unscreened as from 200 m.

Screen all signal and motor cables. Please observe the corresponding installation instructions in chapter 4.2 und 4.3.



Task (FIG 5-3):

In a tank the water is to be held at a constant level. The speed of the pump must be controlled depending on the amount of water delivered.

Functions used

- Internal PID controller for level control.
 - Normal control, analog setpoint selection via terminal 8 with feedback via analog input E1 with plug-in module 8279.

Code settings:

Code	Name	Possible settings		IMPORTANT
		Lenze	Selection	
C005	Configuration	-0-	-6- Operation with closed-loop control; setpoint via terminal 8 with digital frequency feedback via terminal E1	
C070	Gain PID controller	1.00	1.00	Adapt to process
C071	Integral action time PID controller	100	100 ms	Adapt to process
C072	Differential component PID controller	0.0	0.0	Adapt to process
C074	Influence PID controller	0.0	100%	
C238	Frequency precontrol	-1-	-0- No precontrol	
C239	Frequency setting range	-0-	-1- Unipolar	Direction of rotation cannot be changed via process controller

All other parameters are based on the factory setting.

Set the rated motor data (depends on the motor used) under C088 (rated motor current) and C091 (motor $\cos \varphi$).

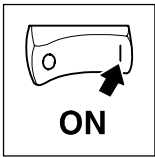

Commissioning

5.7 Signal-flow charts

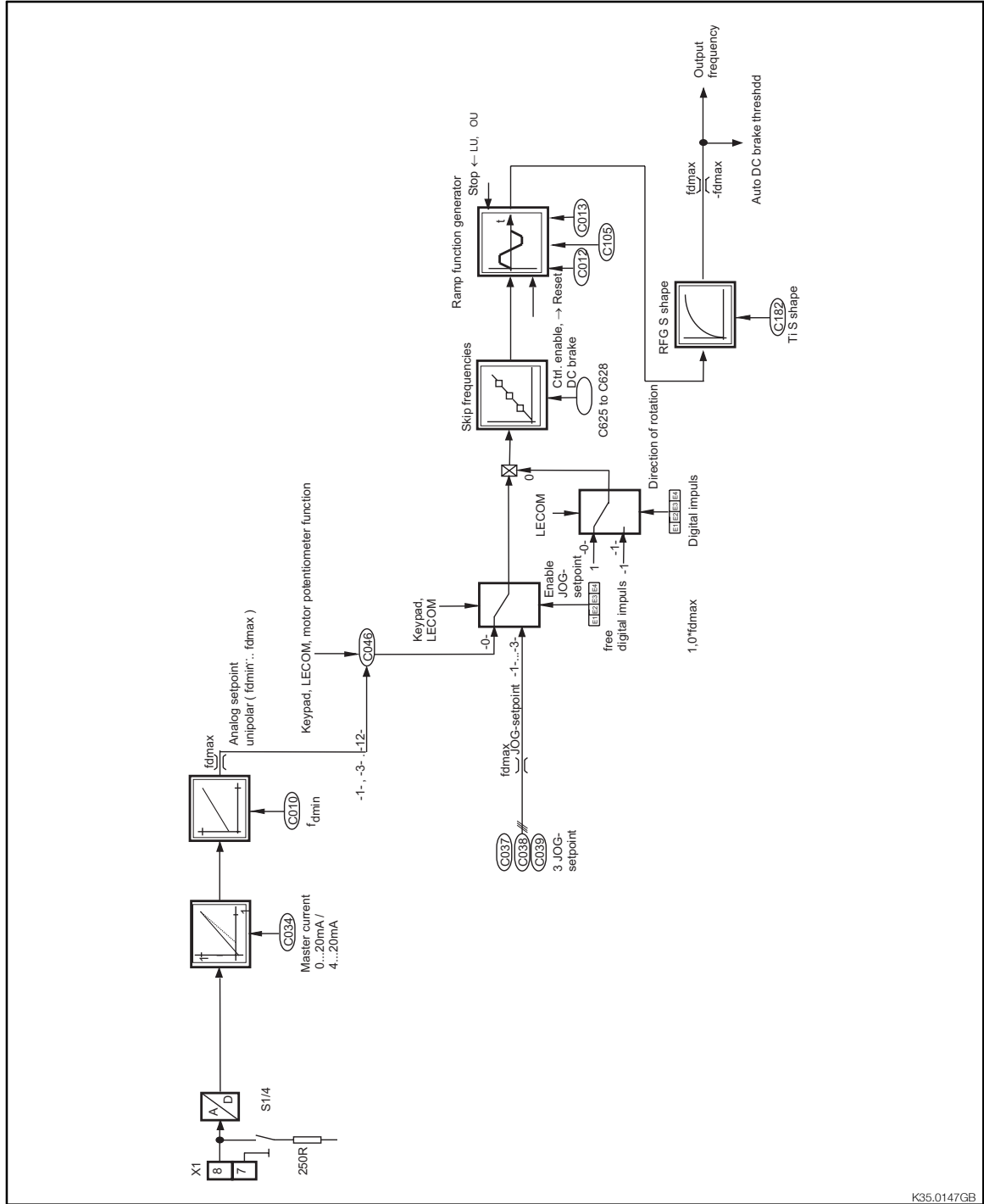

FIG 5-4 Process and speed controller for C005 = 0

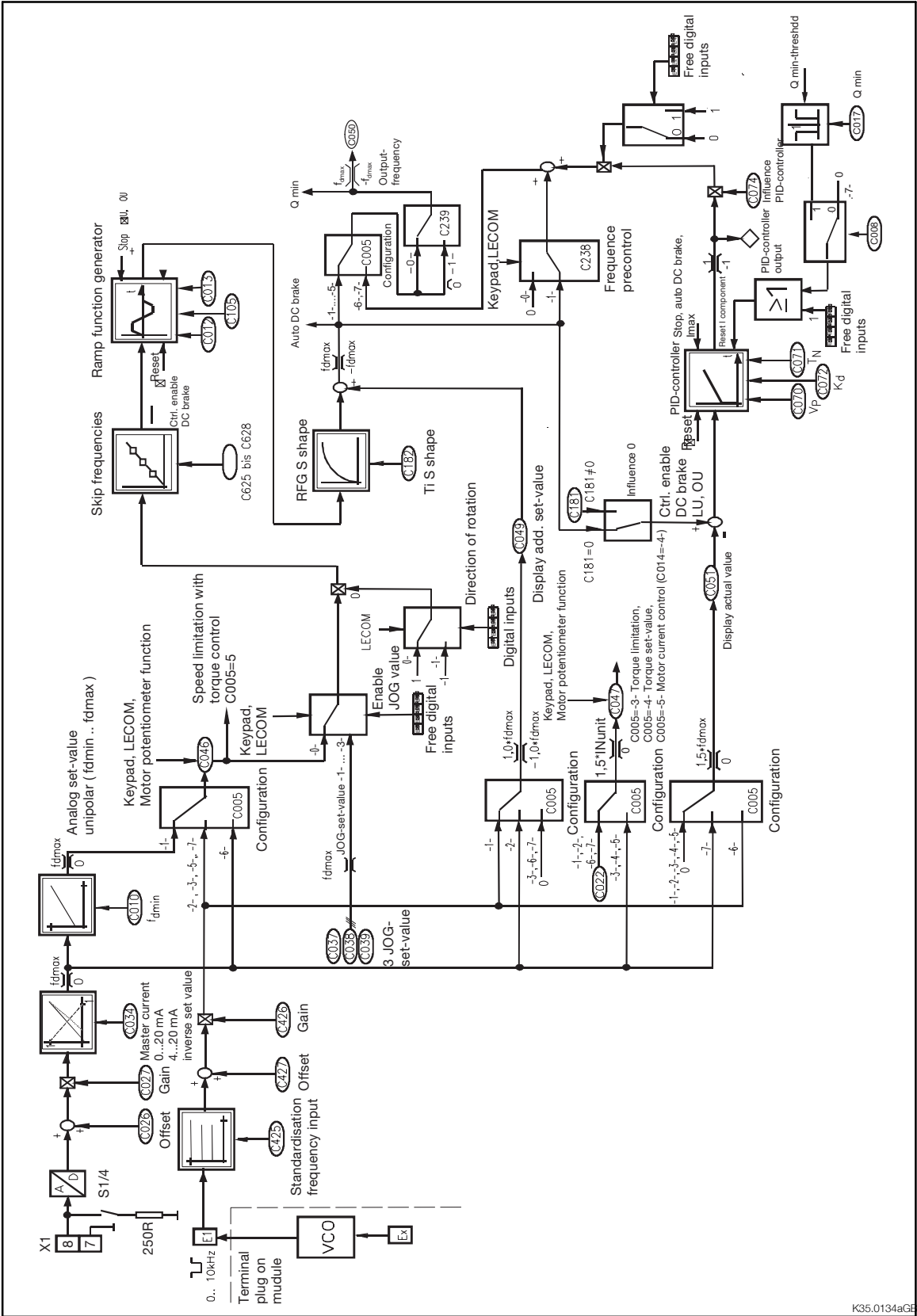
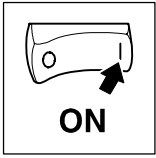
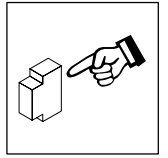

FIG 5-5 Process and speed controller for C005 = 1 ... 7



Commissioning



6 During operation

- Replace defective fuses with the prescribed type only when no voltage is applied.
There are no fuses in the controller.
- Cyclic mains switching:
 - Do not switch on the controller more than every 3 minutes, otherwise the internal initial-current limitation can be overloaded.
- Switching on the motor side:
 - Permissible for emergency switch-off.
 - Monitoring messages can be activated when switching the motor when the controller is enabled.
- Depending on the controller settings, the connected motor can be overheated:
 - For instance, longer DC-braking operations.
 - Longer operation of self-ventilated motors at low speed.
- The controllers generate an output frequency of up to 480 Hz when setting it correspondingly:
 - If an inappropriate motor is connected, a hazardous overspeed may occur.
- If you use the function CW/CCW (selection of the direction of rotation) with the configuration C007 = -0- to -13-:
 - The drive can reverse the direction of rotation in the event of a control-voltage failure or a cable break.
- If you use the function "Flying-restart circuit" (C142 = -2-, -3-) with machines with low inertia torque and friction:
 - The motor can start for a short time or reverse the direction of rotation for a short time after enabling the controller when the motor is in standstill.
- The controllers 822X/824X have a temperature-dependent fan circuit:
 - The fans are only activated when the heat sink temperature, which is a fixed factory setting, is exceeded.

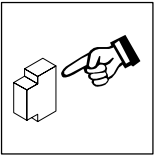

During operation

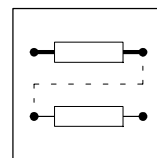

7 Configuration

7.1 Basics

- The configuration of the controller is used to adapt the drive to your applications.
- For this, you have the following functions available:
 - Operating functions
 - Control function
 - Display functions
 - Monitoring functions
- The possible function settings are organized in codes:
 - Codes are numerically sorted, starting from the code with the smallest number to the one with the highest number. All codes start with a "C".
 - They are listed in the code table.
 - Each code provides parameters which can be used to adjust and optimize your drive.
- The configuration of the controller can be entered by means of the keypad of the 8201BB operating module or by means of a fieldbus via the serial interface.
 - The operating module and fieldbus modules are available as accessories.
- The changing of parameters by means of the operating module or fieldbus modules is described
 - in the Operating Instructions of the modules.
 - in the Manual.
- All functions of the controller are described shortly in the code table.



Note!

The functions are described in detail in the Manual.

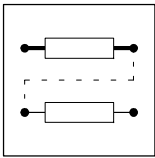

Configuration

7.2 Code table

How to read the code table:

Column	Abbreviation	Meaning
Code	C013	Code C013 <ul style="list-style-type: none"> The parameter of the code can be different in PAR1 and PAR2. The parameter value is accepted immediately (ONLINE).
	C009*	<ul style="list-style-type: none"> The parameter value of the code is always the same in PAR1 and PAR2, but is always displayed in PAR1.
	C001 ↵	<ul style="list-style-type: none"> The parameter value of the code will be accepted after pressing SH+PRG.
	[C002]	<ul style="list-style-type: none"> The parameter value of the code will be accepted after pressing SH+PRG but only if the controller is inhibited.
Name	820X	Name of the code. Unit-specific setting possibilities (here for 820X). Without unit designation the code is valid for all unit types.
Lenze		Factory setting of the code
	*	The column "Important" contains further information
Selection	1 {1 %} 99	Min. value {Steps/Unit} Max. Value
Info	-	Meaning of the code
IMPORTANT	-	Additional, important explanation of the code

Code	Name	Possible settings			IMPORTANT
		Lenze	Selection	Info	
C001 ↵	Operating mode	-0-	-0- Setpoint selection via term. 8 Control via terminals Parameter setting via 8201BB -1- Setpoint selection via 8201BB or via LECOM Control via terminals Parameter setting via 8201BB -2- Setpoint selection via term. 8 Control via terminals Parameter setting via LECOM -3- Setpoint selection via LECOM Control via LECOM Parameter setting via LECOM		
[C002]*	Parameter set	-0-	-0- Function executed -1- Overwrite PAR1 with factory setting -2- Overwrite PAR2 with factory setting -3- Overwrite PAR1 and PAR2 with the data of the operating module -4- Overwrite PAR1 with the data of the operating module -5- Overwrite PAR2 with the data of the operating module -6- Transmit PAR1 and PAR2 to the operating module -7- Overwrite PAR1, PAR2 and the unit-dependent data (C016, C036, C088, C091) with the data of the operating module.		

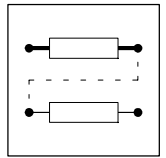

Code	Name	Possible settings			IMPORTANT		
		Lenze	Selection	Info			
C003 ↙	Save parameter set	-1-	-0- -1-	Data will not be saved on EEPROM; all data will be lost when switching off the mains Data will be saved on EEPROM; setting when switching on the mains	-0- only valid for C010, C011, C012, C013, C037, C038, C105, C181 and C182		
C004 ↙	Switch-on display	-0-	-0- -1- -2-	Field frequency f_d Unit load Motor current			
C005 ↙	Configuration	-0-	-0- -1- -2- -3- -4- -5- -6- -7-	Operation with open-loop control via terminal 8 Operation with open-loop control via terminal 8 with setpoint summation via frequency input E1 Operation with open-loop control via frequency input E1 with setpoint summation via terminal 8 Operation with open-loop control via frequency input E1 with torque limitation via terminal 8 Torque selection via terminal 8 with speed limitation via f_{dmax} (C011) Torque selection via terminal 8 with speed limitation via frequency input E1 Operation with closed-loop control; setpoint via terminal 8 with digital frequency feedback via terminal E1 Operation with closed-loop control, setpoint via frequency input E1 with analog feedback via terminal 8	Selections -4- and -5- are only permitted for motor-current control (C014 = 4) and with activated flying restart circuit (C142 = 2, 3).		
C007 ↙	Terminal configuration	-0-	E4 -0- -1- -2- -3- -4- -5- -6- -7- -8- -9- -10-	E3 DC brake PAR QSP PAR DC brake PAR DC brake PAR QSP QSP Trip set UP	E2 JOG1/2/3 JOG1/2/3 JOG1/2/3 DC brake PAR Trip set Trip set PAR PAR Trip set Trip set UP	E1 JOG1 JOG1 JOG1 JOG1 JOG1 JOG1 JOG1 JOG1 JOG1 DOWN	<ul style="list-style-type: none"> • CW = CW rotation • CCW = CCW rotation • DC brake = DC injection brake • PAR = Change of parameter sets • JOG = JOG frequency • QSP = Quick stop

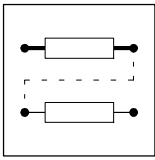

Configuration

Code	Name	Possible settings				Info	IMPORTANT
		Lenze	Selection				
C007 ↵ (continued)	Terminal configuration	-0-	E4	E3	E2	E1	
			-11- CW/CCW	DC brake	UP	DOWN	<ul style="list-style-type: none"> • Trip-Set = External fault • UP/DOWN = Motor potentiometer functions • M/R = Manual/Remote changeover • I-OFF = Reset I-component of the PID controller • D/F = Digital frequency input 0 - 10 kHz • INFL_0 = Set influence of the PID controller to 0 <p>When changing between the parameter sets via terminal, the corresponding terminal must be assigned with PAR in both parameter sets.</p>
			-12- CW/CCW	PAR	UP	DOWN	
			-13- CW/CCW	QSP	UP	DOWN	
			-14- CCW/QSP	CW/QSP	DC brake	JOG1	
			-15- CCW/QSP	CW/QSP	PAR	JOG1	
			-16- CCW/QSP	CW/QSP	JOG1/2/3		
			-17- CCW/QSP	CW/QSP	PAR	DC brake	
			-18- CCW/QSP	CW/QSP	PAR	Trip set	
			-19- CCW/QSP	CW/QSP	DC brake	Trip set	
			-20- CCW/QSP	CW/QSP	Trip set	JOG1	
			-21- CCW/QSP	CW/QSP	UP	DOWN	
			-22- CCW/QSP	CW/QSP	UP	JOG1	
			-23- M/R	CW/CCW	UP	DOWN	
			-24- M/R	PAR	UP	DOWN	
			-25- M/R	DC brake	UP	DOWN	
			-26- M/R	JOG1	UP	DOWN	
			-27- M/R	Trip set	UP	DOWN	
			-28- JOG1/2/3		I-OFF	D/F	
			-29- JOG1	DC brake	I-OFF	D/F	
			-30- JOG1	QSP	I-OFF	D/F	
			-31- DC brake	QSP	I-OFF	D/F	
			-32- Trip set	QSP	I-OFF	D/F	
			-33- QSP	PAR	I-OFF	D/F	
			-34- CW/QSP	CCW/QSP	I-OFF	D/F	
			-35- JOG1/2/3		PAR	D/F	
			-36- DC brake	QSP	PAR	D/F	
			-37- JOG1	QSP	PAR	D/F	
			-38- JOG1	PAR	Trip set	D/F	
			-39- JOG1/2/3		Trip set	D/F	
			-40- JOG1	QSP	Trip set	D/F	
			-41- JOG1	DC brake	Trip set	D/F	
			-42- QSP	DC brake	Trip set	D/F	
			-43- CW/CCW	QSP	Trip set	D/F	
			-44- UP	DOWN	PAR	D/F	
			-45- CW/CCW	QSP	PAR	D/F	
			-46- M/R	PAR	QSP	JOG1	
			-47- CW/QSP	CCW/QSP	M/R	JOG1	
			-48- INFL_0	DC brake	I-OFF	D/F	
			-49- INFL_0	JOG1	QSP	D/F	
			-50- INFL_0	JOG1	I-OFF	D/F	
			-51- DC brake	PAR	I-OFF	D/F	

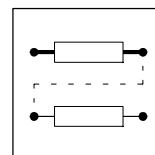

Code	Name	Possible settings			IMPORTANT	
		Lenze	Selection	Info		
C008 _↓	Function relay K1	-1-	-0-	Ready for operation		
			-1-	TRIP fault message		
			-2-	Motor is running		
			-3-	Motor is running / CW rotation		
			-4-	Motor is running / CCW rotation		
-5-	Field frequency $f_d = 0$					
-6-	f_{dset} reached					
-7-	Q_{min} reached					
-8-	I_{max} reached					
-9-	Overtemperature ($\Theta_{max} - 10 \text{ }^\circ\text{C}$)					
-10-	TRIP or Q_{min} or IMP					
822X/824X		-11-	PTC warning			
		-12-	Apparent motor current (C054) < threshold C156			
		-13-	Apparent motor current (C054) < threshold C156 and $f_d > Q_{min}$ threshold (C017)			
		-14-	Apparent motor current (C054) < threshold C156 and input of ramp function generator = output of ramp function generator			
822X/824X		-15-	Warning motor phase failure			
		-16-	f_d (C050) < f_{dmin} (C010)			
C009*	Device address	1	1	{1} 99		Only for LECOM applications
C010	Minimum field frequency	0.00	0.00	{0.02Hz} 480.00		
C011	Maximum field frequency	50.00	7.50	{0.02Hz} 480.00		
C012	Acceleration time	5.00	0.00	{0.02s} 1300.00		
C013	Deceleration time	5.00	0.00	{0.02s} 1300.00		
C014 _↓	Operating mode		-2-	Linear characteristic $V \sim f_d$ with constant V_{min} boost		
			-3-	Square characteristic $V \sim f_d^2$ with constant V_{min} boost		
			-4-	Motor-current control		
C015	V/f rated frequency	50.00	7.50	{0.02Hz} 960.00		
C016	V_{min} setting	0.00	0.00	{0.2 %} 40.0		depends on the unit
C017	Threshold Q_{min}	0.00	0.00	{0.02Hz} 480.00		
C018 _↓	Chopper frequency	-1-	-0-	4kHz reduced power loss		
			-1-	8kHz, reduced power loss		
			-2-	12kHz reduced power loss		
			-3-	16kHz reduced power loss		
			-4-	4kHz reduced noise emission		
			-5-	8kHz reduced noise emission		
			-6-	12 kHz reduced noise emission		
			-7-	16 kHz reduced noise emission		
C019	Threshold auto DC brake	0.10	0.00	{0.02Hz} 5.00		
C021	Slip compensation	0,0	-50.0	{0.1 %} 50.0		* when C014 = 2, 3
		0,0	0.0	{0.1 %} 20.0		* when C014 = 4 * depends on the unit
C022	I_{max} limit motor mode	150	30	{1 %} 150		

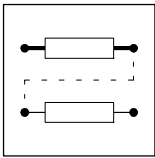

Configuration

Code	Name	Possible settings				IMPORTANT
		Lenze	Selection		Info	
C023	I_{\max} limit generator mode	80	30	{1 %}	150	The current-limit controller for operation in generator mode is not active at 30 %.
C026*	Offset adjustment analog input	0.00	-10.00	{0.01 V}	10.00	
C027*	Scaling factor of analog input	100.0	-200.0	{0.1 %}	200.0	
C034	Master current	-0-	-0- -1-	0 to 20mA / 0 to 5V / 0 to 10V 4 to 20mA		
C035*	Selection DC brake	-0-	-0- -1-	Selection of brake voltage under C036 Selection of brake current under C036		
C036	Voltage for DC brake	*	0	{0.02 %}	150	* depends on the unit
C037	JOG value 1	20.00	-480.00	{0.02Hz}	480.00	
C038	JOG value 2	30.00	-480.00	{0.02Hz}	480.00	
C039	JOG value 3	40.00	-480.00	{0.02Hz}	480.00	
C040	Controller enable	*	-0- -1-	Controller inhibited Controller enabled		* see Operating Instructions 2102
C043	TRIP reset	*	-0- -1-	No current fault Current fault		* see Operating Instructions 2102
C046	Frequency setpoint	*	-480.00	{0.02 %}	480.00	* see Operating Instructions 2102
C047*	Torque setpoint I_{\max} limit value					Only display • C005 = 4, 5 - Torque setpoint • C005 = 1, 2, 3, 6, 7 - I_{\max} limit value (C022)
C049*	Additional setpoint					Only display • Only when C005 = 1, 2
C050*	Output frequency					Only display
C051*	Actual PID controller value					Only display
C052*	Motor voltage					Only display
C053*	DC-bus voltage					Only display
C054*	Motor current					Only display
C056*	Unit load					Only display
C061*	Heat sink temperature					Only display
C070	Gain PID controller	1.00	0.00	{0.01}	300.00	0.0 = P-component inactive
C071	Integral action time PID controller	100	10ms		9999s	9999s = I-component inactive
C072	Differential component PID controller	0.0	0.0	{0.1}	5.0	0.0 = D-component inactive
C074	Influence PID controller	0.0	0.0	{0.1 %}	100.0	

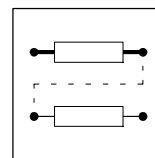

Code	Name	Possible settings				IMPORTANT
		Lenze	Selection		Info	
C077*	Gain I_{\max} controller	0.25	0.00	{0.01}	1.00	
C078*	Integral action time I_{\max} controller	65	12	{1 ms}	9990	
C079	Oscillation damping					* depends on the unit
	822X/824X	5	0	{1}	80	
C088	Rated motor current	*	0	{1 A}	480	* depends on the unit
C091	Motor cos φ	*	0.0 ... 2.0 · rated output current			* depends on the unit
			0.4	{0.1}	1.0	
C093*	Type					Only display
		821X	821X			
		822X	822X			
		824X	824X			
C099*	Software version		82 3x	(Software 3x)		Only display
C105	Deceleration time QSP	5.00	0.00	{0.02s}	1300.00	
C106	Holding time for autom. DC injection brake	0.02	0.00	{0.01s}	999.00	
C108*	Gain (C111)	128	0	{1}	255	

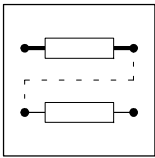

Configuration

Code	Name	Possible settings				IMPORTANT		
		Lenze	Selection				Info	
C111	Monitor signal	-0-	-0-	Field frequency			Selection -9- ... -25- corresponds to the relay output functions C008 and C117: • LOW = 0 V • HIGH = 10 V	
			-1-	Unit load				
			-2-	Motor current				
			-3-	DC-bus voltage				
			-4-	Motor power				
			-5-	Motor voltage				
			-6-	Analog output 1/f _d (1/C050)				
			-7-	Field frequency of f _{dmin} (C010) ... f _{dmax} (C011)				
			-8-	Actual PID controller value				
				-9-	Ready for operation			
		-10-	TRIP fault message					
		-11-	Motor is running					
		-12-	Motor is running / CW rotation					
		-13-	Motor is running / CCW rotation					
		-14-	Field frequency f _d = 0					
		-15-	f _{dsoll} reached					
		-16-	Q _{min} reached					
		-17-	I _{max} reached					
		-18-	Overtemperature (θ _{max} -10°)					
		-19-	Setting of TRIP, Q _{min} or Imp					
	822X/824X		-20-	PTC warning				
			-21-	Apparent motor current (C054) < current threshold (C156)				
			-22-	Apparent motor current (C054) < current threshold (C156) and f _d > Q _{min} threshold				
			-23-	Apparent motor current (C054) < threshold (C156) and input of ramp function generator = output of ramp function generator				
	822X/824X		-24-	Warning motor phase failure				
			-25-	f _d (C050) < f _{dmin} (C010)				
C114	Signal level digital inputs	-0-	E4	E3	E2	E1	0: Ex is not inverted 1: Ex is inverted	
			-0-	0	0	0		0
			-1-	0	0	0		1
			-2-	0	0	1		0
			-3-	0	0	1		1
			-4-	0	1	0		0
			-5-	0	1	0		1
			-6-	0	1	1		0
			-7-	0	1	1		1
			-8-	1	0	0		0
			-9-	1	0	0		1
			-10-	1	0	1		0
			-11-	1	0	1		1
			-12-	1	1	0		0
			-13-	1	1	0		1
			-14-	1	1	1		0
-15-	1	1	1	1				

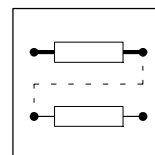

Code	Name	Possible settings					IMPORTANT		
		Lenze	Selection					Info	
C115 _↙	Priority mask digital inputs	-0-	E4	E3	E2	E1	0: Function Ex depends on C001 1: Function Ex is independent of C001 • Ctrl. inhibit and TRIP reset always have first priority. • With -0- also TRIP set and QSP have priority.		
			-0-	0	0	0		0	
			-1-	0	0	0		1	
			-2-	0	0	1		0	
			-3-	0	0	1		1	
			-4-	0	1	0		0	
			-5-	0	1	0		1	
			-6-	0	1	1		0	
			-7-	0	1	1		1	
			-8-	1	0	0		0	
			-9-	1	0	0		1	
			-10-	1	0	1		0	
			-11-	1	0	1		1	
			-12-	1	1	0		0	
			-13-	1	1	0		1	
			-14-	1	1	1		0	
-15-	1	1	1	1					
C117 _↙	Function relay K2	-0-	-0-	Ready for operation					
			-1-	TRIP fault message					
			-2-	Motor is running					
			-3-	Motor is running / CW rotation					
			-4-	Motor is running / CCW rotation					
			-5-	Field frequency $f_d = 0$					
			-6-	f_{dset} reached					
			-7-	Q_{min} reached					
			-8-	I_{max} reached					
			-9-	Overtemperature ($\vartheta_{max} - 10\text{ °C}$)					
			-10-	TRIP or Q_{min} or IMP					
				822X/824X	-11-	PTC warning			
					-12-	Apparent motor current (C054) < threshold C156			
					-13-	Apparent motor current (C054) < threshold C156 and $f_d > Q_{min}$ threshold (C017)			
					-14-	Apparent motor current (C054) < threshold C156 and input of ramp function generator = output of ramp function generator			
				822X/824X	-15-	Warning motor phase failure			
		-16-	f_d (C050) < f_{dmin} (C010)						
C119 _↙	Function PTC 822X/824X	-0-	-0-	PTC input not active					
			-1-	PTC input active, TRIP and pulse inhibit will be set					
			-2-	PTC input active, warning					
C120	$I^2 \cdot t$ switch off 822X/824X	0	0	{1 %}	100				
C125 _↙ *	LECOM baud rate	-0-	-0-	9600 baud			Only for LECOM applications		
			-1-	4800 baud					
			-2-	2400 baud					
			-3-	1200 baud					
			-4-	19200 baud					

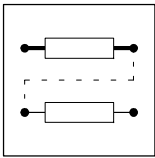

Configuration

Code	Name	Possible settings			IMPORTANT
		Lenze	Selection	Info	
C126*	Selection of communication errors	-0-	-0- -1-	No TRIP when stopping the communication in the process channel TRIP (-CEO-) when stopping the communication in the process channel	Only for bus operation
C127	Selection Setpoint selection	-0-	-0- -1-	Absolute setpoint selection in Hz via C046 or process channel Standardized setpoint selection via C141 (0 ... 100 %) or process channel ($\pm 16384 = f_{dmax}$ (C011))	Only for bus operation
C135*	Control word				see Operating Instructions 2102
C141*	Standardized setpoint		-100.00 {0.01 %} 100.00		Only for bus operation Only when C127 = 1 active
C142↓	Start condition	-1-	-0- -1- -2- -3-	Automatic start inhibited, flying-restart circuit not active Automatic start, if term. 28 HIGH, flying-restart circuit not active Automatic start inhibited, flying-restart circuit active Automatic start, if term. 28 HIGH, flying-restart circuit active	
C144↓	Chopper-frequency reduction	-1-	-0- -1-	No chopper-frequency lowering Automatic chopper-frequency lowering when $\vartheta_{max} - 10$ °C	
C150*	Status word				see Operating Instructions 2102
C156*	Current threshold	0	0 {1 %} 150		
C161*	Current fault				Only display
C162*	Last fault				Only display
C163*	Last but one fault				Only display
C164*	Last but two fault				Only display
C170↓	TRIP-reset selection		-0- -1-	TRIP-reset by pressing the STP key or LOW signal at ctrl. enable Auto-TRIP reset	
C171	Delay for Auto-TRIP-Reset	0.00	0.00 {0.01s} 60.00		
C178*	Operating time				Only display
C179*	Mains switch-on time				Only display
C181*	Setpoint PID controller	0.00	-480.00 {0.02 Hz} 480.00		Only when C181 \neq 0 active
C182*	Integration time ramp function generator S-shape	0.00	0.00 {0.01 s} 50.00		<ul style="list-style-type: none"> • C182 = 0.00 - Linear ramp function generator • C182 > 0.00 - Ramp function generator S shape with T_i time = C182
C196* ↓	Input condition autom. DC injection brake	-0-	-0- -1-	DC brake active at C050 < C019 DC brake active at C050 < C019 and setpoint < C019	

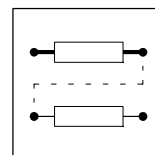

Code	Name	Possible settings			IMPORTANT
		Lenze	Selection	Info	
C200	Software EKZ				
C238	Frequency precontrol	-1-	-0- No precontrol -1- With setpoint precontrol		
C239	Frequency setting range	-0-	-0- Bipolar -1- Unipolar		
C304	Password1				Should only be changed by the Lenze Service!
C305	Password2				
C306	Contents of the address				
C307	Address				
C377*	Gain Zk-voltage detection 822X/824X				
C395	LWORD process input data				Only for bus operation
C396	LWORD process output data				Only for bus operation
C425	Adjustment of digital frequency	-2-	Dig.- Reso- Scann- Max.- freq. lution ing freq. -0- 100 Hz 1/200 1 s 300 Hz -1- 1 kHz 1/200 100 ms 3 kHz -2- 10 kHz 1/200 10 ms 10 kHz -3- 10 kHz 1/1000 50 ms 10 kHz -4- 10 kHz 1/10000 500 ms 10 kHz		When using the analog input module 8279 for the frequency input E1: • Set C425 to 2, 3 or 4
C426*	Gain adjustment frequency input E1	100	-200.0 {0.1 %} 200.0		
C427*	Offset adjustment frequency input E1	0.0	-12.5 {0.1 %} 12.5		
C500*	Display factor application datum numerator	2000	1 {1} 25000		
C501*	Display factor for process variable denominator	10	1 {1} 25000		
C597*	Activation of motor-phase failure detection 822X/824X	-0-	-0- Inactive -1- TRIP -2- Warning		
C599*	Current limit value motor-phase failure detection 822X/824X	5	1 {1 %} 50		
C625*	Frequency 1	480.00	0.00 {0.02 Hz} 480.00		
C626*	Frequency 2	480.00	0.00 {0.02 Hz} 480.00		
C627*	Frequency 3	480.00	0.00 {0.02 Hz} 480.00		

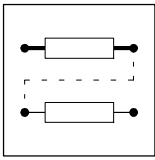

Configuration

Code	Name	Possible settings			Info	IMPORTANT
		Lenze	Selection			
C628*	Bandwidth of frequencies	0.00	0.00	{0.01 %}	100.00	
C988*	DC-bus voltage threshold for DC-bus voltage control	0	0	{1 %}	200	<ul style="list-style-type: none"> • C988 = 0% <ul style="list-style-type: none"> - No parameter set changeover via DC-bus voltage • C988 = 1 ... 200% <ul style="list-style-type: none"> - Parameter set changeover via DC-bus voltage active <p>Parameter set changeover via terminal or LECOM is not possible when C988 > 0!</p>



8 Troubleshooting and fault elimination

You can recognize immediately whether a fault has occurred by display elements or status information (chapter 8.1).

The faults can be analysed by using the history buffer (chapter 8.2) and the list in chapter 8.3. This list helps you to eliminate the faults.

8.1 Troubleshooting

8.1.1 Display at the controller

During operation without operating module two LED at the unit front indicate the operating status.

LED		Operating status
green	red	
on	off	Controller enabled
on	on	Mains switched on, automatic start inhibited (AS_LC)
blinking	off	Controller inhibited
off	blinking every second	Fault message, check under C161
off	blinking every 0.4 seconds	Undervoltage switch-off
off	off	Programming mode

8.1.2 Display at the operating module

Status indications in the display indicate the controller status.

Display	Meaning
OV	Overvoltage
UV	Undervoltage
IMAX	Set current limit exceeded
TEMP	Heat sink temperature near switch-off



Troubleshooting and fault elimination

8.1.3 Maloperation of the drive

Maloperation	Possible causes
Motor does not rotate	<ul style="list-style-type: none"> • DC-bus voltage too low (Red LED is blinking every 0.4 seconds; message LU is displayed) • Controller inhibited (green LED is blinking, display of the operating module: OFF, STOP or AS_LC) • Setpoint = 0 • DC braking active • Quick-stop function active • JOG setpoint activated and JOG frequency = 0 • Fault message is displayed (see chapter 8.3) • Mechanical motor brake is not released
Motor does not rotate smoothly	<ul style="list-style-type: none"> • Defective motor cable • Maximum current C022 and C023 too low • Motor underexcited or overexcited (check parameter setting)
Current consumption of motor too high	<ul style="list-style-type: none"> • Setting of C016 too high • Setting of C015 too low • C088 and C091 are not adapted to the motor data.

8.2 Fault analysis using the history buffer

The history buffer is used to trace faults. The fault messages are stored in the history buffer in the order of their occurrence.

The memory locations can be retrieved via the codes.

Structure of the history buffer			
Code	C0168	Entry	Note
C161	Memory location 1	Active fault	If the fault is no longer active or has been acknowledged: <ul style="list-style-type: none"> • The contents of the memory locations 1-3 will be saved in a "higher" location. • The contents of the memory location 4 will be eliminated from the history buffer and cannot be read any longer. • Memory location 1 will be deleted (= no active fault).
C162	Memory location 2	Last fault	
C163	Memory location 3	Last but one fault	
C164	Memory location 4	Last but two fault	



8.3 Fault indications

Display	Fault	Cause	Remedy
---	No fault	-	-
EEr	External fault (TRIP-Set)	A digital input assigned to the TRIP-Set function has been activated	Check external encoder
H05	Internal fault		Contact Lenze
LP1	Motor phase failure	<ul style="list-style-type: none"> • Failure of one or several motor phases • Motor current too low 	Check motor cables, check V_{\min} setting, connect motor with corresponding power or adapt motor under C599.
LU	Undervoltage	DC-bus voltage too low	<ul style="list-style-type: none"> • Check mains voltage • Check supply module
OC1	Short circuit	Short circuit	Find out cause of short circuit; check cable
		Excessive capacitive charging current of the motor cable	Use motor cable which is shorter or of lower capacitance
OC2	Earth fault	Grounded motor phase	Check motor; check cable
		Excessive capacitive charging current of the motor cable	Use motor cable which is shorter or of lower capacitance
OC3	Overload inverter during acceleration or short circuit	Acceleration time too short (C012)	<ul style="list-style-type: none"> • Increase acceleration time • Check drive selection
		Defective motor cable	Check wiring
		Interturn fault in the motor	Check motor
OC4	Overload controller during deceleration	Deceleration time too short (C013)	<ul style="list-style-type: none"> • Increase deceleration time • Check the selection of the brake resistor or connect the brake chopper
OC5	I x t overload	Frequent and too long acceleration processes with overcurrent	Check drive dimensioning
OC6	Overload motor	Motor is thermally overloaded, for instance, because of <ul style="list-style-type: none"> • impermissible continuous current • frequent or too long acceleration processes 	<ul style="list-style-type: none"> • Check drive selection • Check the setting under C120
OH	Heat sink temperature is higher than the value set in the controller	Ambient temperature $T_{\text{amb}} > +40\text{ °C}$ or $+50\text{ °C}$	<ul style="list-style-type: none"> • Allow controller to cool and ensure ventilation • Check the ambient temperature in the control cabinet
		Heat sink very dirty	Clean heat sink
		Incorrect mounting position	Change mounting position
OH3	PTC monitoring (TRIP)	Motor too hot because of excessive current or frequent and too long acceleration	Check drive dimensioning
		PTC not connected	Connect PTC or switch-off monitoring (C0585=3)
OH4	Overtemperature unit	Inside unit too hot	<ul style="list-style-type: none"> • Reduce controller load • Improve cooling • Check fan in the controller
OH51	PTC monitoring (Warning)	Motor too hot because of excessive current or frequent and too long acceleration	Check drive dimensioning
		PTC not connected	Connect PTC or switch-off monitoring (C0585=3)



Troubleshooting and fault elimination

Display	Fault	Cause	Remedy
OV	Overvoltage	Mains voltage too high	Check voltage supply
		Feedback operation Braking operation	<ul style="list-style-type: none"> • Increase deceleration times. • For operation with brake choppers: <ul style="list-style-type: none"> - Check the selection and connection of the brake resistor - Increase the deceleration times
		Earth leakage on the motor side	Check motor cable and motor for earth fault (disconnect motor from inverter)
Pr	Faulty parameter transfer via the operating module	PAR1 and PAR2 are defective.	It is absolutely necessary to repeat the data transfer or load the factory setting before enabling the controller.
Pr1	Faulty PAR1 transfer via the operating module	PAR1 is defective.	
Pr2	Faulty PAR2 transfer via the operating module	PAR2 is defective.	
rSt	Faulty auto-TRIP reset	More than 8 fault messages in 10 minutes	Depends on the fault message



8.4 Reset of fault indications

TRIP

After eliminating the fault, the pulse inhibit will only be reset after the acknowledgement of TRIP.



Note!

If the TRIP source is still active, the TRIP cannot be reset.

Code	Name	Possible settings			IMPORTANT
		Lenze	Selection	Info	
C170 ↓	TRIP-reset selection		-0- TRIP-reset by pressing the STP key or a LOW signal at ctrl. enable -1- Auto-TRIP reset		
C171	Delay for Auto-TRIP-Reset	0.00	0.00 {0.01s} 60.00		

Function

You can select whether the fault is to be reset automatically or manually.

Activation

C170 = -0-:

- Manual TRIP-reset
- STP key
- LOW signal at terminal 28

C170 = -1-:

Auto-TRIP reset resets all faults after the time set under C171.

Important

- Mains switching always resets TRIP.
- With more than 8 Auto-TRIP resets within 10 minutes, the controller sets TRIP and indicates rST.



Troubleshooting and fault elimination

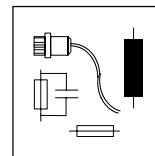

9 Accessories (Overview)

9.1 Accessories for all types

Name	Order number
8201BB operating module	EMZ8201BB
Diagnosis terminal (2.5 m cable)	EMZ8272BB-V001
Diagnosis terminal (5.0 m cable)	EMZ8272BB-V002
Diagnosis terminal (10 m cable)	EMZ8272BB-V003
Digital display	EPD203
Setpoint potentiometer	ERP0001k0001W
Rotary button for potentiometer	ERZ0001
Scale for potentiometer	ERZ0002
RS232/485 fieldbus module	EMF2102IB-V001
RS485 fieldbus module	EMF2102IB-V002
Level converter for RS485	EMF2101IB
PC system cable RS232/485	EWL0020
Optical fibre fieldbus module	EMF2102IB-V003
Optical fibre adaptor for PLC 0...40m	EMF2125IB
Supply unit for optical fibre adaptor 2125	EJ0013
InterBus-S module	EMF2111IB
PROFIBUS module	EMF2131IB
System bus module (CAN)	EMF2171IB
System bus module (CAN) with addressing	EMF2172IB
PTC module	EMZ8274IB
I/O module	EMZ8275IB
Monitor module	EMZ8276IB
Bipolar setpoint module	EMZ8278IB
Analog module	EMZ8279IB

9.2 Software

Name	Order number
PC program for Global Drive controllers	ESP-GDC 1

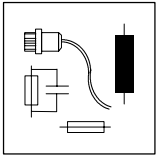

Accessories

9.3 Type-specific accessories

9.3.1 Types 822X

Name	Order number			
	8221	8222	8223	8224
Mains filter type A	EZN3A0110A030	EZN3A0080A042	EZN3A0060H054	
Mains filter type B	EZN3B0110A030	EZN3B0080A042	EZN3B0060H054	
Mains choke	ELN3-088H035	ELN3-0075H045	ELN3-0055H055	ELN3-0038H085
Motor filter	ELM3-004H055	ELM3-004H055	on request	on request
Sine filter	on request	on request	on request	on request
Brake module	EMB9351-E	EMB9351-E	EMB9351-E	EMB9351-E
Brake chopper	EMB9352-E	EMB9352-E	EMB9352-E	EMB9352-E (2 x)
Brake resistor	ERBD033R02k0	ERBD022R03k0	ERBD018R03k0	ERBD022R03k0 (2 x)
Thermal separation ("Push-through technique")	EJ0011	EJ0011	EJ0011	EJ0011
DC-bus fuse	EFSCC0500AYJ	EFSCC0800AYJ	EFSCC1000AYJ	EFSCC0800AYJ (2 x)
Fuse holder	EFH20004	EFH20004	EFH20004	EFH20004 (2 x)

Name	Order number		
	8225	8226	8227
Mains filter type A			
Mains filter type B			
Mains choke	ELN3-0027H105	ELN3-0022H130	ELN3-0017H170
Motor filter	on request	on request	on request
Sine filter	on request	on request	on request
Brake module	EMB9351-E	EMB9351-E	EMB9351-E
Brake chopper	EMB9352-E (2 x)	EMB9352-E (3 x)	EMB9352-E (3 x)
Brake resistor	ERBD018R03k0 (2 x)	ERBD022R03k0 (3 x)	ERBD018R03k0 (3 x)
Thermal separation ("Push-through technique")			
DC-bus fuse	EFSCC1000AYJ (2 x)	EFSCC0800AYJ (3 x)	EFSCC1000AYJ (3 x)
Fuse holder	EFH20004 (2 x)	EFH20004 (3 x)	EFH20004 (3 x)

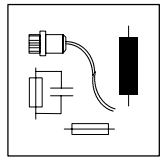

9.3.2 Types 824X

Name	Order number			
	8241	8242	8243	8244
E.l.c.b.	EFA3B06A	EFA3B06A	EFA3B10A	EFA3B10A
Fuse	EFSM-0060AWE	EFSM-0060AWE	EFSM-0100AWE	EFSM-0100AWE
Fuse holder	EFH10001	EFH10001	EFH10001	EFH10001
Mains filter type A	EZN3A2400H002	EZN3A1500H003	EZN3A0900H004	EZN3A0500H007
Mains filter type B	EZN3B2400H002	EZN3B1500H003	EZN3B0900H004	EZN3B0500H007
Motor filter	ELM3-030H004	ELM3-030H004	ELM3-014H010	ELM3-014H010
Sine filter	EZS3-002A001	EZS3-004A001	EZS3-006A001	EZS3-010A001
Brake module	EMB9351-E	EMB9351-E	EMB9351-E	EMB9351-E
Brake chopper	EMB9352-E	EMB9352-E	EMB9352-E	EMB9352-E
Brake resistor	ERBD180R300W	ERBD180R300W	ERBD082R600W	ERBD068R800W
Thermal separation ("Push-through technique")	EJ0036	EJ0036	EJ0037	EJ0037
DC-bus fuse	EFSCC0060AYJ	EFSCC0060AYJ	EFSCC0080AYJ	EFSCC0120AYJ
Fuse holder	EFH20004	EFH20004	EFH20004	EFH20004

Name	Order number	
	8245	8246
E.l.c.b.	EFA3B13A	EFA3B20A
Fuse	EFSM-0160AWE	EFSM-0200AWE
Fuse holder	EFH10001	EFH10001
Mains filter type A	EZN3A0300H013	EZN3B0300H013
Mains filter type B	EZN3B0300H013	ELN3-0160H012
Motor filter	ELM3-014H010	EZN3A0150H024
Sine filter	EZS3-009A002	EZN3B0150H024
Brake module	EMB9351-E	EMB9351-E
Brake chopper	EMB9352-E	EMB9352-E
Brake resistor	ERBD047R01k2	ERBD047R01k2
Thermal separation ("Push-through technique")	EJ0038	EJ0038
DC-bus fuse	EFSCC0200AYJ	EFSCC0400AYJ
Fuse holder	EFH20004	EFH20004

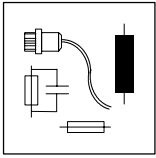

Accessories

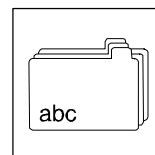

10 Index

A

- Acceleration times, 5-4
- Adapt the motor, 5-6
- Analog plug-in module
 - Assembly, 4-3
 - Features, 3-13
 - Technical data, 3-13
- Application, as directed, 1-2
- Application conditions, 2-1
- Application examples, 5-13
 - Air conditioning, 5-13
 - Pump application with level control, 5-18
 - Pump application with pressure control, 5-16
- Applications as directed, 1-2
- Approvals, 2-1
- Assembly
 - Analog plug-in module, 4-3
 - With fixing brackets
 - Types 822X, 4-2
 - Types 824X, 4-2
- Auto-TRIP reset, 8-5

C

- Cable cross-sections, Single drives, 3-11
 - 120 % overload, 3-11
 - 150 % overload, 3-12
- Code table, 7-2
 - Information on the, 7-2
- Commissioning, 5-1
- Configuration, 7-1
 - Acceleration and deceleration times, 5-4
 - Basic information, 7-1
 - Code table, 7-2
 - Current-limit values, 5-5
 - Maximum field frequency, 5-3
 - Minimum field frequency, 5-3
- Connection
 - Analog plug-in module, 4-13
 - Control, Connection diagram, 4-12
 - Control cables, 4-10
 - Mains, 4-5
 - Motor, 4-6
 - Power, Circuit diagram, 4-9
 - Temperature monitoring, 4-11
- Connection diagram
 - Analog plug-in module, 4-13
 - Control connections, 4-12
 - Power connection, 4-9
- Connections, Power, 4-5
- Control cables, 4-10
- Control connections, 4-10
- Control mode, permissible, 5-6
- Control terminals, 4-11
 - Protection against polarity reversal, 4-11
 - Survey, 4-11
 - Terminal assignment, 4-11
- Controller, 1-1
 - Application as directed, 1-2
 - Labelling, 1-2
- Current-limit values, 5-5

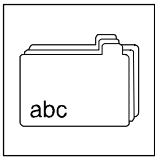

Index

D

- Deceleration times, 5-4
- Definitions of terminology used, 1-1
- Degree of pollution, 2-1
- Derating, 5-5
- Dimensions
 - 822X with fixing brackets, 4-2
 - 824X with fixing brackets, 4-2
 - Analog plug-in module, 3-14
 - Controller, 3-14
- Display
 - LED-, 8-1
 - Operating status, 8-1
- Drive parameters, Factory setting, 5-2
- Drive system, 1-1

E

- Electrical installation, 4-4
 - Important notes, 4-4
- EMC
 - Assembly, 4-14
 - CE-typical drive system, Installation, 4-14
 - Filters, 4-14
 - Grounding, 4-14
 - Installation, 4-14
 - Screening, 4-14
- Enclosure, 2-1

F

- Factory setting
 - Important drive parameters, 5-2
 - Short set-up, 5-2
 - Switch-on sequence, 5-2
- Fans, Application of 82XX, 3-2
- Fault analysis, 8-2
- Fault messages, 8-3
 - Reset, 8-5
- Field frequency
 - Maximum, 5-3
 - Minimum, 5-3
- Frequency inverter. See Controller
- Fuses
 - in UL-approved systems, 3-11
 - Single drives, 3-11
 - 120 % overload, 3-11
 - 150 % overload, 3-12

G

- General data, 2-1

H

- History buffer, 8-2
 - Structure, 8-2
- Humidity class, 2-1

I

- Initial switch-on, 5-1
- Inputs
 - Analog, 4-11
 - Digital, 4-11
- Installation, 4-1
 - CE-typical drive system, 4-14
 - Assembly, 4-14
 - Filters, 4-14
 - Grounding, 4-14
 - Screening, 4-14
 - Electrical, 4-4
 - Mechanical, 4-1
- Installation height, 2-1
- Insulation strength, 2-1

J

- Jumper, Analog setpoint selection, 4-11

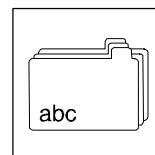
**L**

Labelling, Controller, 1-2
LED, 8-1
Legal regulations, 1-2
Liability, 1-2

M

Mains connection, 4-5
Mains-voltage compensation, 5-8
Maloperation of the drive, 8-2
Manufacturer, 1-2
Mechanical installation, 4-1
Messages, Fault, 8-3
Monitor output, 4-11
Monitoring, Motor temperature, 4-11
Motor, Adapt, 5-6
Motor cable, Screening, 4-6
Motor connection, 4-6
 Types 822X, 4-6
 Types 824X, 4-7
Motor temperature monitoring, 4-11
Mounting positions, Types 822X/824X, 4-1

N

Noise emission, 2-1
Noise immunity, 2-1

O

Operating module, Fault display, 8-1
Operating status, Display, 8-1
Operation, Status display, 8-1
Operator's safety, 2-2
Outputs, Analog, 4-11
Overspeeds, 2-2

P

Packaging, 2-1
PID controller, 5-11
Power connections, 4-5
Protection against contact, 4-11
Protection against polarity reversal, 4-11
Pumps, Application of 82XX, 3-2

R

Rated data
 Types 8221-8224
 120 % overload, 3-3
 150 % overload, 3-7
 Types 8225-8227
 120 % overload, 3-4
 150 % overload, 3-8
 Types 8241-8243
 120 % overload, 3-5
 150 % overload, 3-9
 Types 8244-8246
 120 % overload, 3-6
 150 % overload, 3-10

Relay output, 4-11
Reset, Fault message, 8-5
Residual hazards, 2-2

S

Safety information, 2-1
 for controllers to Low-Voltage Directive, 2-1
 Layout, 2-2
Safety notes, Layout
 Other notes, 2-2
 Warning of damage to material, 2-2
 Warning of danger to persons, 2-2
Scope of delivery, 1-1
Screening
 EMC, 4-14
 Motor cable, 4-6
Short set-up, 5-2
Signal-flow charts, 5-20
Switch-on, Initial, 5-1
Switch-on sequence, Factory setting, 5-2

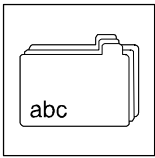

Index

T

- Technical data, 2-1
 - Analog plug-in module, 3-13
 - Features, 3-13
 - General data/application conditions, 2-1
- Temperature monitoring, 4-11
- Temperature ranges, 2-1
- Transport, storage, 2-1
- TRIP, 8-5
- Troubleshooting, 8-1
 - Display at the operating module , 8-1
 - Fault analysis using the history buffer , 8-2
 - Fault indication, 8-3
 - LED, 8-1
 - Maloperation of the drive, 8-2
 - Reset of fault indications, 8-5
 - TRIP, 8-5

U

- Unit protection, 2-2

V

- Vibration resistance, 2-1

W

- Warranty, 1-2
- Waste disposal, 1-2

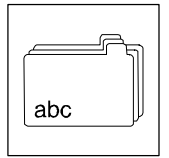

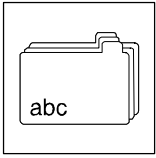

Index