

ASPL 33.0008
13457111

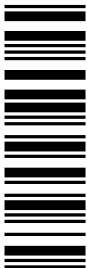

接线图

Wiring diagram

M...

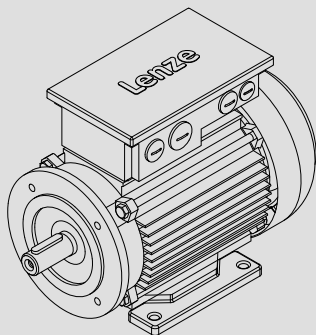

M□□MA, M□ERA... V1; KK0, KK1

交流电机



AC motors

Lenze

B-14 法兰螺纹孔尺寸

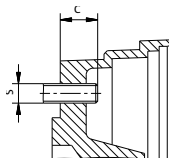
Screw-on dimensions for B-14 flange

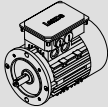

		c max.	s
	[mm]	[mm]	
MDERA□□056 V1	FT65	11	M5
MDERA□□063 V1	FT75	14	M5
MDERA□□071 V1	FT85	14	M6
MDERA□□080 V1	FT100	16	M6
MDERA□□090 V1	FT115	14	M8
MDERA□□100 V1	FT130	19	M8
MDERA□□112 V1	FT130	21	M8
MDERA□□132 V1	FT165	22	M10
MD□MA□N□□			
M□□MA□N063	FT75	10	M5
M□□MA□N071	FT85	10	M6
M□□MA□N080	FT100	12	M6
M□□MA□N080	FT130	16	M8
M□□MA□N090	FT115	14	M8
M□□MA□N090	FT130	16	M8
M□□MA□N100	FT130	14	M8
M□□MA□N112	FT130	16	M8
MHERA□□□□			
MHERA□□080□	FT100	15	M6
MHERA□□090□	FT115	16	M8
MHERA□□100□	FT130	18	M8
MHERA□□112□	FT130	19	M8
MHERA□□132□	FT165	23	M10

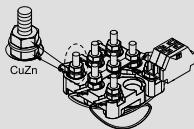
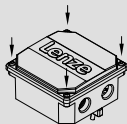

M4	2.2 Nm	± 10%	1.2 Nm	± 10%
M5	3.5 Nm		2.0 Nm	
M6	4.5 Nm		3.0 Nm	
M8	-----		6.0 Nm	



开始使用前请先阅读本指导说明！

本指导说明仅在随附于标准设备和电机的完整文档中时有效！



技巧!

有关 Lenze 产品的信息和辅助设备请查询以下网址的下载区

<http://www.Lenze.com>



危险!

如果忽视下列基本安全措施，可能导致严重的人员受伤以及财产损失：



注释!

颜色编码方案参照Lenze系统电缆!



警告!

用于法兰安装电机的重要安装指导

本操作说明表明电机外壳上含有螺纹孔或穿孔。

- ▶ 这些孔不可用于安装底脚。
- ▶ 电机仅可采用无底脚固定安装方式进行安装。

安全指导

- ▶ Lenze 驱动与自动化组件...
 - ... 仅用于预设目的。
 - ... 损坏时切勿使用。
 - ... 不可进行任何技术改动。
 - ... 未完成组装前切勿进行任何操作。
 - ... 无防护罩或防护装置时切勿进行任何操作。
 - ... 根据其防护等级，在运行期间或运行后均可能存在带电、移动或旋转部件。表面也可能是热的。
- ▶ 请注意在所附的相关文件中预先规定的所有条件。
这是保证安全和无故障运行并达到规定产品性能的前提条件。
- ▶ 只能由具备资质的专业技术人员来操作Lenze驱动与自动化组件。
根据IEC 60364或CENELEC HD 384, 这些人员应 ...
 - ... 熟悉产品的安装、组装、调试和操作,
 - ... 具备所在岗位的职业资质,
 - ... 熟悉并可恰当引用使用地的相关意外防护章程、指令和适用的法律法规。
- ▶ 即使插头已拔开，电源端子上仍存在危险电压：残余电压>60 V!
- ▶ 在对电源端口进行任何操作前，务必先（如果有的话）从电源上断开电机和控制器并确保电机已处于静止状态（即断开电机旋转时触点上的电压）。
- ▶ 烧伤危险！
 - 运行期间表面温度可达140 °C! 提供防触保护措施。
- ▶ 小心旋转轴，可能会有受伤危险！
 - 对电机进行任何操作前应先确保电机处于静止状态。
- ▶ 带插头的设计：
 - 接电期间切勿断开插头！否则插头可能受损！
 - 拔开插头前请先断开电源并禁用控制器。

安装注释

- ▶ 使用适当的方式进行设备的运输和升降!
- ▶ 轴不可受任何敲打或撞击! 否则电机可能损坏! 驱动组件应通过螺纹法兰安装于电机轴上。拆装时需使用提取设备。安全固定联轴器。
- ▶ 紧固好电机并确保通风无阻。
- ▶ 紧固好连接头的联轴圈。
- ▶ 电机需小心接地, 并检查布线。
- ▶ 在电机和控制器上需确保电机电缆的屏蔽范围。



停止!

注意用于B14法兰的最大可容许啮合长度 □ 2!

电气连接

从端子盒盖内可找到电源连接信息!



注释!

- ▶ 为了确保安全运行, 请遵照容差为 $\pm 10\%$ 的紧固力矩(□3).

温度监控连接

接线排/接线板		
含义	名称 (EN 60034-8)	注释
热触点 TCO	TB1	最大 250 V~ 最大 1.6 A~
	TB2	
PTC 热敏电阻	TP1	
	TP2	
热敏元件 +KTY	R1	注意极性
热敏元件 -KTY	R2	

可用于所有热敏元件的接线板或端子



Please read these instructions before you start working!

These instructions are only valid together with the complete documentation of the standard device and the motor!



Tip!

Information and auxiliary devices related to the Lenze products can be found in the download area at

<http://www.Lenze.com>



Danger!

Disregarding the following basic safety measures may lead to severe personal injury and damage to material assets!



Note!

The colour coding scheme refers to Lenze system cables!



Warnings!

Important installation instructions for flange-mounted motors

The operating instructions indicates that the motor housing has threaded holes or through holes.

- ▶ These holes may not be used to install feet.
- ▶ Motor mounting is only allowed as fixed installation without feet.

Safety instructions

- ▶ Lenze drive and automation components ...
 - ... must only be used for the intended purpose.
 - ... must never be operated if damaged.
 - ... must never be subjected to technical modifications.
 - ... must never be operated unless completely assembled.
 - ... must never be operated without the covers/guards.
 - ... can - depending on their degree of protection - have live, movable or rotating parts during or after operation. Surfaces can be hot.
- ▶ All specifications of the corresponding enclosed documentation must be observed. This is vital for a safe and trouble-free operation and for achieving the specified product features.
- ▶ Only qualified skilled personnel are permitted to work with or on Lenze drive and automation components.

According to IEC 60364 or CENELEC HD 384, these are persons ...

 - ... who are familiar with the installation, assembly, commissioning and operation of the product,
 - ... possess the appropriate qualifications for their work,
 - ... and are acquainted with and can apply all the accident prevent regulations, directives and laws applicable at the place of use.
- ▶ Hazardous voltage at the power terminals, even if the plug is removed: residual voltage >60 V!
- ▶ Before carrying out work on the power connections, always disconnect the motor and controller, if any, from the mains and wait until the motor is at standstill (voltage at the contacts when the motor is rotating).
- ▶ Risk of burns!
 - Hot surfaces up to 140 °C during operation! Provide protection against contact.
- ▶ Risk of injury due to rotating shaft!
 - Before working on the motor ensure that the motor is at standstill.
- ▶ Design with plug:
 - Never disconnect plug when energised! Otherwise, the plug can be destroyed.
 - Disconnect power supply or inhibit controller prior to disconnecting the plug.

Notes for mounting

- ▶ Use an appropriate means of transport and lifting equipment!
- ▶ The shaft must not be exposed to knocks or bumps! Motor can be destroyed! Drive elements must be mounted on the motor shaft via the threading. An extracting device must be used when dismantling. Fasten coupling securely.
- ▶ Fasten motor and ensure unimpeded ventilation.
- ▶ Tighten coupling ring of connector.
- ▶ Motor must be carefully earthed, check cabling.
- ▶ Extensive shielding of motor cable on motor and controller.



Stop!

Observe the maximally permissible length of engagement for B14 flanges,
 2!

Electrical connection

The power connection data can be found inside the terminal box cover!



Note!

- ▶ In order to ensure a safe operation, comply with the tightening torques with a tolerance of $\pm 10\%$ (3).

Connection of temperature monitoring

Terminal strip / terminal board		
Meaning	Designation in accordance with EN 60034-8	Note
Thermal contact TCO	TB1	Max. 250 V~ Max. 1.6 A~
	TB2	
PTC thermistor	TP1	
	TP2	
Thermal sensor +KTY	R1	Observe polarity
Thermal sensor -KTY	R2	

Terminal board or terminal possible for all thermal sensors



© 12/2013



Lenze Drives GmbH
Postfach 10 13 52
D-31763 Hameln
Germany



+49 (0)51 54 / 82-0



+49 (0)51 54 / 82-28 00



Lenze@Lenze.de



www.Lenze.com

Service Lenze Service GmbH
Breslauer Straße 3
D-32699 Extertal
Germany



00 80 00 / 24 4 68 77 (24 h helpline)



+49 (0)51 54 / 82-13 96



Service@Lenze.de

ASPL 33.0008 ■ 13457111 ■ ZH/EN ■ 1.0 ■ TD09

10 9 8 7 6 5 4 3 2 1