

Information for the operator of the machine

9300 vector 0.37 ... 11 kW

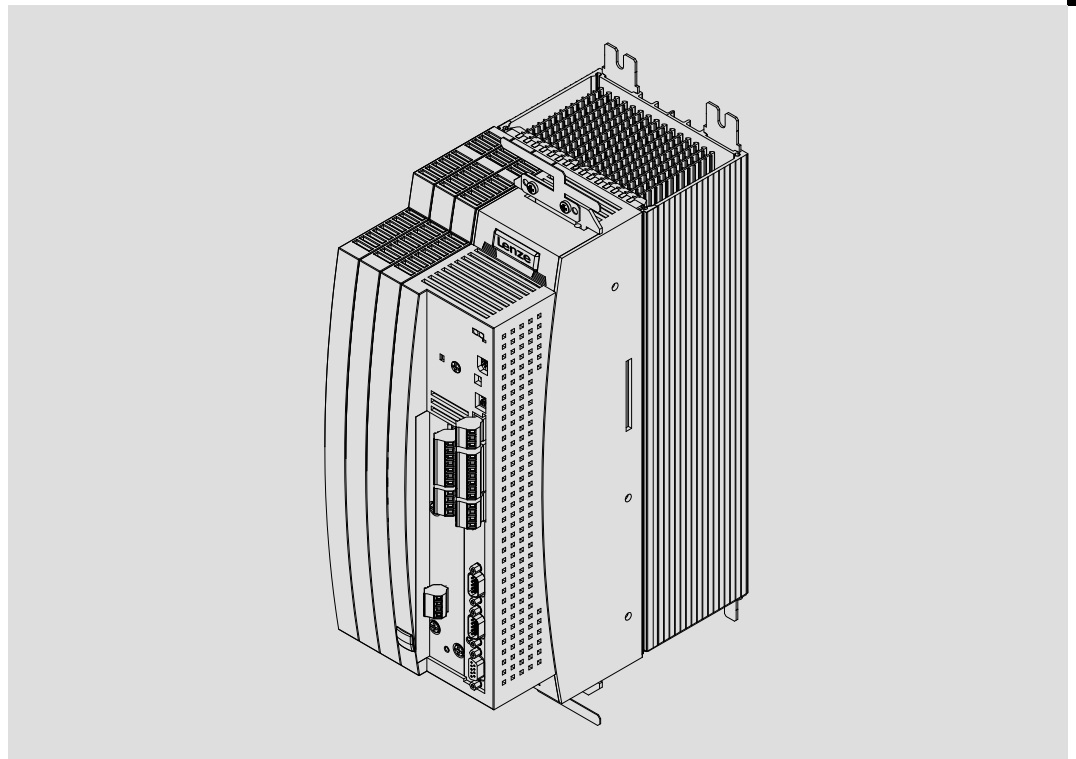

EVF9321-xV ... EVF9326-xV

Frequency inverter

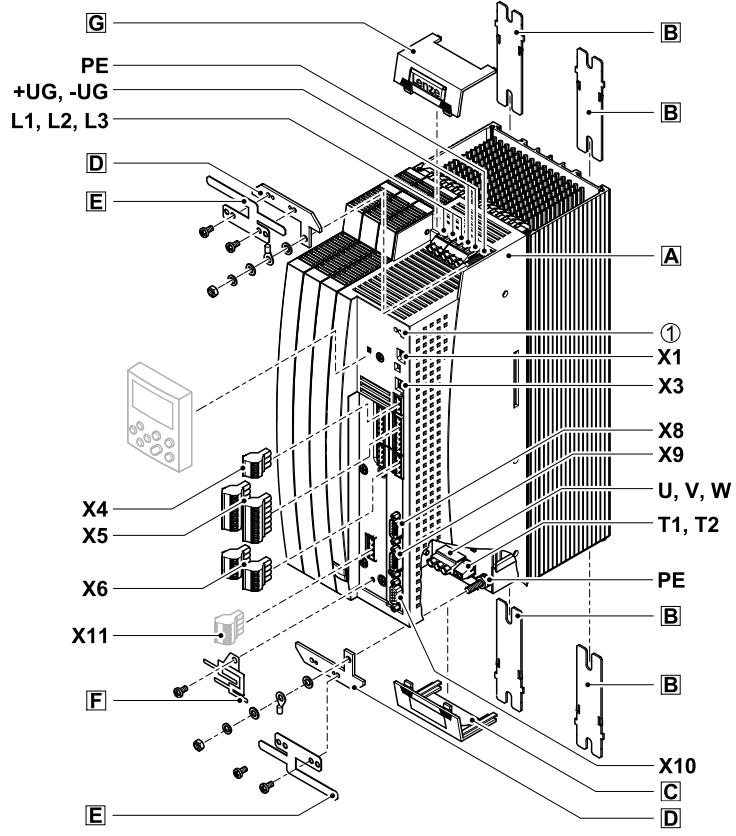

Key for overview

Position	Description
A	Controller
B	Fixing rails for standard mounting
C	Cover for the motor connection
D	Shield connection support with fixing screws (2 items) 1 support for the shield sheet for the supply connections 1 support for the shield sheet for the motor cable
E	EMC shield sheet with fixing screws (2 items) 1 shield sheet for the supply connections 1 shield sheet for the motor cable and the feed cable for the motor temperature monitoring with PTC thermistor or thermal contact (NC contact)
F	EMC shield sheet with fixing screws for shielded control cables
G	Cover for the supply connections

Connections and interfaces

Position	Description
L1, L2, L3, PE	Mains connection
+UG, -UG	DC supply
U, V, W, PE	Motor connection
T1, T2	Connection of PTC thermistor or thermal contact (NC contact) of the motor
X1	AIF interface (automation interface) Slot for communication module (e. g. XT EMZ9371BC keypad)
X3	Jumper for setting analog input signal at X6/1, X6/2
X4	System bus (CAN) connection
X5	Connection of digital inputs and outputs
X6	Connection of analog inputs and outputs
X8	Connection of incremental encoder with TTL level or SinCos encoder and KTY temperature sensor of the motor
X9	Connection of digital frequency input signal
X10	Connection of digital frequency output signal
X11	Connection of K _{SR} relay output for "safe standstill" (for variants V004 and V024 only)

Status displays

Position	LED red	LED green	Operating status
①	Off	On	Controller is enabled
	On	On	Mains is switched on and automatic start is inhibited
	Off	Blinking slowly	Controller is inhibited
	Off	On	Motor data identification is active
	Blinking quickly	Off	Undervoltage or overvoltage
	Blinking slowly	Off	Active fault

1	About this documentation	5
1.1	Document history	5
1.2	Target group	5
1.3	Validity information	6
1.4	Conventions used	7
1.5	Notes used	8
2	Safety instructions	9
2.1	General safety and application notes for Lenze controllers	9
2.2	Thermal motor monitoring	12
2.2.1	Forced ventilated or naturally ventilated motors	13
2.2.2	Self-ventilated motors	14
2.3	Residual hazards	16
2.4	Safety instructions for the installation according to UL	18
3	Parameter setting	20
3.1	Parameter setting with the XT EMZ9371BC keypad	20
3.1.1	General data and operating conditions	20
3.1.2	Installation and commissioning	21
3.1.3	Display elements and function keys	21
3.1.4	Changing and saving parameters	23
3.1.5	Loading a parameter set	25
3.1.6	Transferring parameters to other standard devices	26
3.1.7	Activating password protection	28
3.1.8	Diagnostics	29
3.1.9	Menu structure	30
4	Troubleshooting and fault elimination	32
4.1	Display of operating data, diagnostics	32
4.1.1	Display of operating data	32
4.1.2	Diagnostics	33
4.2	Troubleshooting	34
4.2.1	Status display via controller LEDs	34
4.2.2	Fault analysis with the history buffer	35
4.3	Drive behaviour in the event of faults	36
4.4	Fault elimination	37
4.4.1	Drive errors	37
4.4.2	Controller in clamp operation	38
4.4.3	Behaviour in case of overvoltage in the DC bus (OU message)	39
4.5	System error messages	40
4.5.1	General error messages	40
4.5.2	Resetting system error messages	45

1 About this documentation



Note!

This documentation contains all the information required by the machine operator to run the drive controllers of the 9300 vector series installed in your machine/system.

You may make further use of the information contained in this documentation without asking Lenze for permission if you do not change the contents.

1.1 Document history

What is new / what has changed?

Material number	Version			Description
13445254	3.0	11/2013	TD06	Error corrections
13330574	2.1	03/2010	TD14	Change of the company's address
13330574	2.0	03/2010	TD14	New edition due to reorganisation of the company UL-warnings updated Revision for software version 8x
13217739	1.0	07/2007	TD23	First edition



Tip!

Information and auxiliary devices related to the Lenze products can be found in the download area at

<http://www.Lenze.com>

1.2 Target group

This documentation is directed at qualified skilled personnel according to IEC 60364.

Qualified skilled personnel are persons who have the required qualifications to carry out all activities involved in installing, mounting, commissioning, and operating the product.

1 About this documentation

Validity information

1.3 Validity information





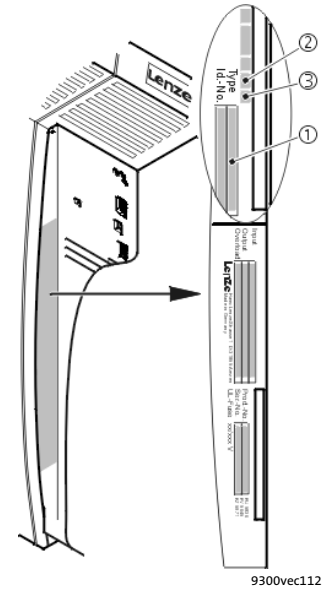

... 9300 vector frequency inverters as of nameplate data:

	①	②	③	Nameplate														
	EVF	93xx	- x V Vxxx	1x 8x														
Product series	Frequency inverter																	
Type no. / rated power	<table border="1"> <tr> <td>400 V</td> <td>480 V</td> </tr> <tr> <td>9321 = 0.37 kW</td> <td>0.37 kW</td> </tr> <tr> <td>9322 = 0.75 kW</td> <td>0.75 kW</td> </tr> <tr> <td>9323 = 1.5 kW</td> <td>1.5 kW</td> </tr> <tr> <td>9324 = 3.0 kW</td> <td>3.0 kW</td> </tr> <tr> <td>9325 = 5.5 kW</td> <td>5.5 kW</td> </tr> <tr> <td>9326 = 11 kW</td> <td>11 kW</td> </tr> </table>				400 V	480 V	9321 = 0.37 kW	0.37 kW	9322 = 0.75 kW	0.75 kW	9323 = 1.5 kW	1.5 kW	9324 = 3.0 kW	3.0 kW	9325 = 5.5 kW	5.5 kW	9326 = 11 kW	11 kW
400 V	480 V																	
9321 = 0.37 kW	0.37 kW																	
9322 = 0.75 kW	0.75 kW																	
9323 = 1.5 kW	1.5 kW																	
9324 = 3.0 kW	3.0 kW																	
9325 = 5.5 kW	5.5 kW																	
9326 = 11 kW	11 kW																	
Type	E = Panel-mounted unit C = Built-in unit in "cold plate" technique																	
Design	V = Vector-controlled frequency inverter																	
Variant	- Standard V003 = In "cold plate" technique V004 = With "safe standstill" function V024 = With "safe standstill" function and for IT mains V100 = For IT mains																	
Hardware version																		
Software version																		



1.4 Conventions used

This documentation uses the following conventions to distinguish between different types of information:

Type of information	Identification	Examples/notes
Spelling of numbers		
Decimal separator	language-dependent	In each case, the signs typical for the target language are used as decimal separators. For example: 1234.56 or 1234,56
Warnings		
UL warnings		Given in English and French
UR warnings		
Text		
Program name	» «	PC software For example: »Engineer«, »Global Drive Control« (GDC)
Icons		
Page reference		Reference to another page with additional information For instance:  16 = see page 16
Documentation reference		Reference to another documentation with additional information For example:  EDKxxx = see documentation EDKxxx

1 About this documentation

Notes used

1.5 Notes used

The following pictographs and signal words are used in this documentation to indicate dangers and important information:

Safety instructions

Structure of safety instructions:





Danger!



(characterises the type and severity of danger)

Note



(describes the danger and gives information about how to prevent dangerous situations)

Pictograph and signal word	Meaning
 Danger!	Danger of personal injury through dangerous electrical voltage. Reference to an imminent danger that may result in death or serious personal injury if the corresponding measures are not taken.
 Danger!	Danger of personal injury through a general source of danger. Reference to an imminent danger that may result in death or serious personal injury if the corresponding measures are not taken.
 Stop!	Danger of property damage. Reference to a possible danger that may result in property damage if the corresponding measures are not taken.

Application notes

Pictograph and signal word	Meaning
 Note!	Important note to ensure troublefree operation
 Tip!	Useful tip for simple handling
	Reference to another documentation

Special safety instructions and application notes

Pictograph and signal word	Meaning
 Warnings!	Safety note or application note for the operation according to UL or CSA requirements.
 Warnings!	The measures are required to meet the requirements according to UL or CSA.

2 Safety instructions

2.1 General safety and application notes for Lenze controllers

(in accordance with Low-Voltage Directive 2006/95/EC)

For your personal safety

Disregarding the following safety measures can lead to severe injury to persons and damage to material assets:

- ▶ Only use the product as directed.
- ▶ Never commission the product in the event of visible damage.
- ▶ Never commission the product before assembly has been completed.
- ▶ Do not carry out any technical changes on the product.
- ▶ Only use the accessories approved for the product.
- ▶ Only use original spare parts from Lenze.
- ▶ Observe all regulations for the prevention of accidents, directives and laws applicable on site.
- ▶ Transport, installation, commissioning and maintenance work must only be carried out by qualified personnel.
 - Observe IEC 364 and CENELEC HD 384 or DIN VDE 0100 and IEC report 664 or DIN VDE 0110 and all national regulations for the prevention of accidents.
 - According to this basic safety information, qualified, skilled personnel are persons who are familiar with the assembly, installation, commissioning, and operation of the product and who have the qualifications necessary for their occupation.
- ▶ Observe all specifications in this documentation.
 - This is the condition for safe and trouble-free operation and the achievement of the specified product features.
 - The procedural notes and circuit details described in this documentation are only proposals. It is up to the user to check whether they can be transferred to the particular applications. Lenze Automation GmbH does not accept any liability for the suitability of the procedures and circuit proposals described.
- ▶ Depending on their degree of protection, some parts of the Lenze controllers (frequency inverters, servo inverters, DC speed controllers) and their accessory components can be live, moving and rotating during operation. Surfaces can be hot.
 - Non-authorized removal of the required cover, inappropriate use, incorrect installation or operation, creates the risk of severe injury to persons or damage to material assets.
 - For more information, please see the documentation.
- ▶ High amounts of energy are produced in the controller. Therefore it is required to wear personal protective equipment (body protection, headgear, eye protection, ear protection, hand guard).

Application as directed

Controllers are components which are designed for installation in electrical systems or machines. They are not to be used as domestic appliances, but only for industrial purposes according to EN 61000-3-2.

When controllers are installed into machines, commissioning (i.e. starting of the operation as directed) is prohibited until it is proven that the machine complies with the regulations of the EC Directive 2006/42/EC (Machinery Directive); EN 60204 must be observed.

Commissioning (i.e. starting of the operation as directed) is only allowed when there is compliance with the EMC Directive (2004/108/EC).

The controllers meet the requirements of the Low-Voltage Directive 2006/95/EC. The harmonised standard EN 61800-5-1 applies to the controllers.

The technical data and supply conditions can be obtained from the nameplate and the documentation. They must be strictly observed.

Warning: Controllers are products which can be installed in drive systems of category C2 according to EN 61800-3. These products can cause radio interferences in residential areas. In this case, special measures can be necessary.

Transport, storage

Please observe the notes on transport, storage, and appropriate handling.

Observe the climatic conditions according to the technical data.

Installation

The controllers must be installed and cooled according to the instructions given in the corresponding documentation.

The ambient air must not exceed degree of pollution 2 according to EN 61800-5-1.

Ensure proper handling and avoid excessive mechanical stress. Do not bend any components and do not change any insulation distances during transport or handling. Do not touch any electronic components and contacts.

Controllers contain electrostatic sensitive devices which can easily be damaged by inappropriate handling. Do not damage or destroy any electrical components since this might endanger your health!

Electrical connection

When working on live controllers, observe the applicable national regulations for the prevention of accidents (e.g. VBG 4).

The electrical installation must be carried out according to the appropriate regulations (e.g. cable cross-sections, fuses, PE connection). Additional information can be obtained from the documentation.

This documentation contains information on installation in compliance with EMC (shielding, earthing, filter, and cables). These notes must also be observed for CE-marked controllers. The manufacturer of the system is responsible for compliance with the limit values demanded by EMC legislation. The controllers must be installed in housings (e.g. control cabinets) to meet the limit values for radio interferences valid at the site of installation. The housings must enable an EMC-compliant installation. Observe in particular that e.g. the control cabinet doors have a circumferential metal connection to the housing. Reduce housing openings and cutouts to a minimum.

Lenze controllers may cause a DC current in the PE conductor. If a residual current device (RCD) is used for protection against direct or indirect contact for a controller with three-phase supply, only a residual current device (RCD) of type B is permissible on the supply side of the controller. If the controller has a single-phase supply, a residual current device (RCD) of type A is also permissible. Apart from using a residual current device (RCD), other protective measures can be taken as well, e.g. electrical isolation by double or reinforced insulation or isolation from the supply system by means of a transformer.

Operation

If necessary, systems including controllers must be equipped with additional monitoring and protection devices according to the valid safety regulations (e.g. law on technical equipment, regulations for the prevention of accidents). The controllers can be adapted to your application. Please observe the corresponding information given in the documentation.

After the controller has been disconnected from the supply voltage, all live components and power terminals must not be touched immediately because capacitors can still be charged. Please observe the corresponding stickers on the controller.

All protection covers and doors must be shut during operation.

Safety functions

Certain controller versions support safety functions (e.g. "Safe torque off", formerly "Safe standstill") according to the requirements of the EC Directive 2006/42/EC (Machinery Directive). The notes on the integrated safety system provided in this documentation must be observed.

Maintenance and servicing

The controllers do not require any maintenance if the prescribed operating conditions are observed.

Disposal

Recycle metal and plastic materials. Ensure professional disposal of assembled PCBs.

The product-specific safety and application notes given in these instructions must be observed!

2.2

Thermal motor monitoring

**Note!**

From software version 8.1 onwards, the 9300 vector controllers are provided with an I^2xt function for sensorless thermal monitoring of the connected motor.

- ▶ I^2xt monitoring is based on a mathematical model which calculates a thermal motor utilisation from the detected motor currents.
- ▶ The calculated motor utilisation is saved when the mains is switched off.
- ▶ The function is UL-certified, i.e. additional protective measures for the motor are not required in UL-approved systems.
- ▶ Nevertheless, I^2xt monitoring does **not** provide full motor protection because other influences on the motor utilisation such as changes in the cooling conditions (e.g. cooling air flow interrupted or too warm) cannot be detected.

The $I^2 \times t$ load of the motor is displayed in C0066.

The thermal loading capacity of the motor is expressed by the thermal motor time constant (τ , C0128). Find the value in the rated motor data or contact the manufacturer of the motor.

The $I^2 \times t$ monitoring has been designed such that it will be activated after 179 s in the event of a motor with a thermal motor time constant of 5 minutes (Lenze setting C0128), a motor current of $1.5 \times I_N$ and a trigger threshold of 100 %.

Two adjustable trigger thresholds provide for different responses.

- ▶ Adjustable response OC8 (TRIP, warning, off).
 - The trigger threshold is set in C0127.
 - The response is set in C0606.
 - The response OC8, for instance, can be used for an advance warning.
- ▶ Fixed response OC6-TRIP.
 - The trigger threshold is set in C0120.

Behaviour of the $I^2 \times t$ monitoring	Condition
The $I^2 \times t$ monitoring is deactivated. C0066 is set = 0 % and MCTRL-LOAD-I2XT is set = 0.00 %.	When C0120 = 0 % and C0127 = 0 %, set controller inhibit.
$I^2 \times t$ monitoring is stopped. The current value in C0066 and at the MCTRL-LOAD-I2XT output is frozen.	When C0120 = 0 % and C0127 = 0 %, set controller enable.
$I^2 \times t$ monitoring is deactivated. The motor load is displayed in C0066.	Set C0606 = 3 (off) and C0127 > 0 %.

**Note!**

An error message OC6 or OC8 can only be reset if the $I^2 \times t$ load falls below the set trigger threshold by 5 %.

2.2.1 Forced ventilated or naturally ventilated motors

Parameter setting

The following codes can be set for I² x t monitoring:

Code	Meaning	Value range	Lenze setting
C0066	Display of the I ² x t load of the motor	0 ... 250 %	-
C0120	Threshold: Triggering of error "OC6"	0 ... 120 %	0 %
C0127	Threshold: Triggering of error "OC8"	0 ... 120 %	0 %
C0128	Thermal motor time constant	0.1 ... 50.0 min	5.0 min
C0606	Response to error "OC8"	TRIP, warning, off	Warning

Calculate release time and I²x t load

Formula for release time	Information
$t = -(\tau) \times \ln \left[1 - \frac{z + 1}{\left(\frac{I_{Mot}}{I_N}\right)^2 \times 100} \right]$	I _{Mot} Actual motor current (C0054)
	I _r Rated motor current (C0088)
	τ Thermal motor time constant (C0128)
	z Threshold value in C0120 (OC6) or C0127 (OC8)

Formulae for I ² x t load	Information
$L(t) = \left(\frac{I_{Mot}}{I_N}\right)^2 \times 100\% \times \left(1 - e^{-\frac{t}{\tau}}\right)$	L(t) Chronological sequence of the I ² x t load of the motor (Display: C0066)
	I _{Mot} Actual motor current (C0054)
	I _r Rated motor current (C0088)
	τ Thermal motor time constant (C0128)

If the controller is inhibited, the I² x t load is reduced:

$L(t) = L_{start} \times \sqrt{e^{-\frac{t}{\tau}}}$	L _{start} I ² x t load before controller inhibit If an error is triggered, the value corresponds to the threshold value set in C0120 (OC6) or C0127 (OC8).
--	---

Read release time in the diagram

Diagram for detecting the release times for a motor with a thermal motor time constant of 5 minutes (Lenze setting C0128):

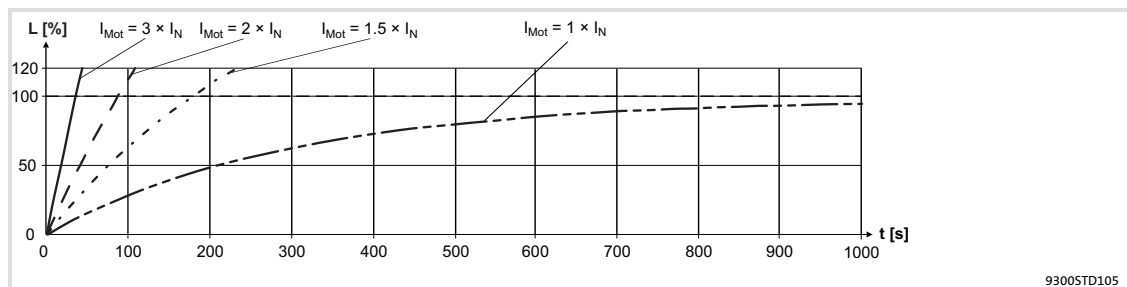

Fig. 2-1 I² x t-monitoring: Release times for different motor currents and trigger thresholds

- I_{Mot} Actual motor current (C0054)
- I_r Rated motor current (C0088)
- L I² x t load of the motor (display: C0066)
- T Time

2.2.2 Self-ventilated motors

Due to the construction, self-ventilated standard motors are exposed to an increased heat generation in the lower speed range compared to forced ventilated motors.

**Warnings!**

For complying with the UL 508C standard, you have to set the speed-dependent evaluation of the permissible torque via code **C0129/x**.

Parameter setting

The following codes can be set for $I^2 \times t$ monitoring:

Code	Meaning	Value range	Lenze setting
C0066	Display of the $I^2 \times t$ load of the motor	0 ... 250 %	-
C0120	Threshold: Triggering of error "OC6"	0 ... 120 %	0 %
C0127	Threshold: Triggering of error "OC8"	0 ... 120 %	0 %
C0128	Thermal motor time constant	0.1 ... 50.0 min	5.0 min
C0606	Response to error "OC8"	TRIP, warning, off	Warning
C0129/1	S1 torque characteristic I_1/I_{rated}	10 ... 200 %	100 %
C0129/2	S1 torque characteristics n_2/n_{rated}	10 ... 200 %	40 %

Effect of code C0129/x

Fig. 2-2 Working point in the range of characteristic lowering

The lowered speed / torque characteristic (Fig. 2-2) reduces the permissible thermal load of self-ventilated standard motors. The characteristic is a line the definition of which requires two points:

- ▶ Point **A**: Definition with **C0129/1**
This value also enables an increase of the maximally permissible load.
- ▶ Point **B**: Definition with **C0129/2**
With increasing speeds, the maximally permissible load remains unchanged ($I_{Mot} = I_{rated}$).

In Fig. 2-2, the motor speed and the corresponding permissible motor torque (**D**) can be read for each working point (**C** on the characteristic (**A**) ... **B**). **D** can also be calculated using the values in **C0129/1** and **C0129/2** (evaluation coefficient "y", 15).

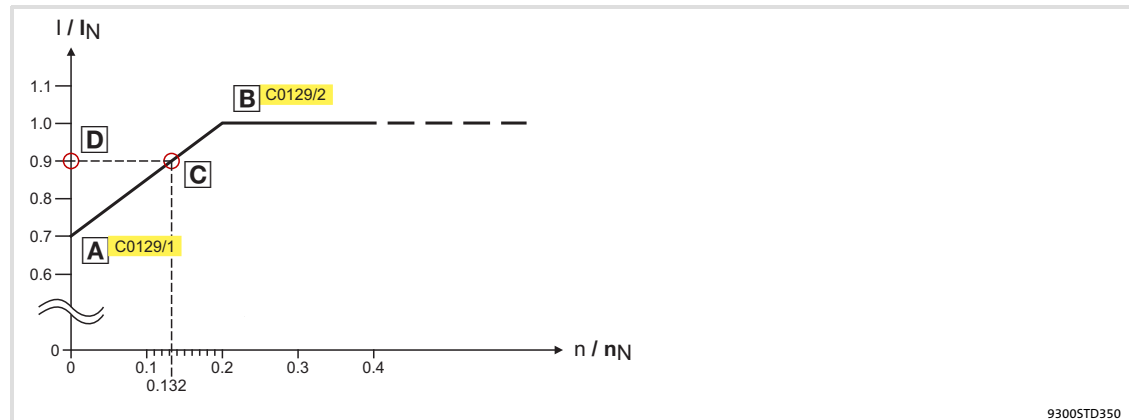
Calculate release time and I²xt load

Calculate the release time and the I² x t load of the motor considering the values in **C0129/1** and **C0129/2**(evaluation coefficient "y").

Formulae for release time	Information	
$T = - (\tau) \times \ln \left[1 - \frac{z + 1}{\left(\frac{I_{Mot}}{y \times I_N} \right)^2 \times 100} \right]$	T	Release time of the I ² x t monitoring
	τ	Thermal motor time constant (C0128)
$y = \frac{100\% - C0129/1}{C0129/2} \times \frac{n}{n_N} + C0129/1$	ln	Function: Natural logarithm
	I _{Mot}	Actual motor current (C0054)
	I _r	Rated motor current (C0088)
	z	Threshold value in C0120 (OC6) or C0127 (OC8)
	y	Evaluation coefficient
	n _{rated}	Rated speed (C0087)

Formulae for I ² x t load	Information	
$L(t) = \left(\frac{I_{Mot}}{y \times I_N} \right)^2 \times 100\% \times \left(1 - e^{-\frac{t}{\tau}} \right)$	L(t)	Chronological sequence of the I ² x t load of the motor (Display: C0066)
	y	Evaluation coefficient
	I _{Mot}	Actual motor current (C0054)
	I _r	Rated motor current (C0088)
	τ	Thermal motor time constant (C0128)

If the controller is inhibited, the I² x t load is reduced:

$L(t) = L_{start} \times \sqrt{e^{-\frac{t}{\tau}}}$	L _{start}	I ² x t load before controller inhibit If an error is triggered, the value corresponds to the threshold value set in C0120 (OC6) or C0127 (OC8).
--	--------------------	--

2.3**Residual hazards****Protection of persons**

- ▶ Before working on the controller, check that no voltage is applied to the power terminals:
 - Because the power terminals V, W, +U_G and -U_G remain live for at least 3 minutes after disconnecting from mains.
 - Because the power terminals L1, L2, L3; U, V, W, +U_G and -U_G remain live when the motor is stopped.
- ▶ The leakage current to earth (PE) is >3.5 mA. According to EN 61800-5-1
 - a fixed installation is required,
 - a double PE connection is required, or, if there is only a single PE connection, the PE conductor must have a cross-section of at least 10 mm².
- ▶ The heat sink of the controller has an operating temperature of > 80 °C:
 - Contact with the heatsink results in burns.
- ▶ If you use the "flying-restart circuit" function (C0142 = 2, 3) for machines with a low moment of inertia and minimum friction:
 - After controller enable in standstill, the motor may start or change its direction of rotation for a short time, because the flying restart process also is carried out at a speed of 0.
- ▶ During parameter set transfer, the control terminals of the controller can have undefined states!
 - Therefore the plugs X5 and X6 must be unplugged, before the transfer is executed. This ensures that the controller is inhibited and all control terminals have the defined "LOW" state.

Device protection

- ▶ Frequent mains switching (e.g. inching mode via mains contactor) can overload and destroy the input current limitation of the drive controller:
 - At least 3 minutes must pass between switching off and restarting the devices EVS9321-xS and EVS9322-xS.
 - At least 3 minutes must pass between two starting procedures of the devices EVS9323-xS ... EVS9332-xS.
 - Use the "safe torque off" safety function (STO) if safety-related mains disconnections occur frequently. The drive variants Vxx4 are equipped with this function.

Motor protection

- ▶ Certain drive controller settings can overheat the connected motor:
 - E. g. long-time operation of the DC injection brake.
 - Long-time operation of self-ventilated motors at low speeds.

Protection of the machine/system

- ▶ Drives can reach dangerous overspeeds (e. g. setting of high output frequencies in connection with motors and machines not suitable for this purpose):
 - The drive controllers do not provide protection against such operating conditions. For this purpose, use additional components.

Original - English**Warnings!**

- ▶ **Motor Overload Protection**
 - For information on the protection level of the internal overload protection for a motor load, see the corresponding manuals or software helps.
 - If the integral solid state motor overload protection is not used, external or remote overload protection must be provided.
- ▶ **Branch Circuit Protection**
 - The integral solid state protection does not provide branch circuit protection.
 - Branch circuit protection has to be provided externally in accordance with corresponding instructions, the National Electrical Code and any additional codes.
- ▶ Please observe the specifications for fuses and screw-tightening torques in these instructions.
- ▶ **EVS9321 ... EVS9326:**
 - Suitable for use on a circuit capable of delivering not more than 5000 rms symmetrical amperes, 480 V maximum, when protected by fuses.
 - Suitable for use on a circuit capable of delivering not more than 50000 rms symmetrical amperes, 480 V maximum, when protected by CC, J, T or R class fuses.
 - Maximum surrounding air temperature: 0 ... +55 °C
 - > +40 °C: reduce the rated output current by 2.5 %/°C
 - Use 75 °C copper wire only.

Original - French



Warnings!

- ▶ Protection du moteur contre les surcharges
 - Pour obtenir des informations sur le niveau de protection offert par la protection intégrée contre les surcharges du moteur, se reporter aux manuels correspondants ou aux systèmes d'aide logiciels.
 - Si la protection statique intégrée contre les surcharges du moteur n'est pas utilisée, prévoir impérativement un dispositif de protection externe ou séparé contre les surcharges.
- ▶ Protection par disjoncteur
 - La protection statique intégrée n'offre pas la même protection qu'un disjoncteur.
 - Une protection par disjoncteur externe doit être fournie, conformément aux indications fournies, au National Electrical Code et aux autres dispositions applicables.
- ▶ Se conformer aux spécifications relatives aux fusibles et aux couples de serrage contenues dans le présent document.
- ▶ EVS9321 ... EVS9326 :
 - Convient aux circuits non susceptibles de délivrer plus de 5000 ampères symétriques eff., maximum 480 V, avec protection par fusibles.
 - Convient aux circuits non susceptibles de délivrer plus de 50000 ampères symétriques eff., maximum 480 V, avec protection par des fusibles CC de calibre J, T ou R.
 - Température ambiante maximale : 0 ... +55 °C
 - > +40 °C: ramener le courant assigné de sortie à 2,5 %/°C
 - Utiliser exclusivement des conducteurs en cuivre 75 °C.

3 Parameter setting

Parameter setting with the XT EMZ9371BC keypad
General data and operating conditions

3 Parameter setting

3.1 Parameter setting with the XT EMZ9371BC keypad

Description

The keypad is available as an accessory. A full description of the keypad can be obtained from the Instructions included in the keypad delivery.

Plugging in the keypad

It is possible to plug the keypad into the AIF interface or remove it during operation.

As soon as the keypad is supplied with voltage, it carries out a self-test. The keypad is ready for operation if it is in display mode.

3.1.1 General data and operating conditions

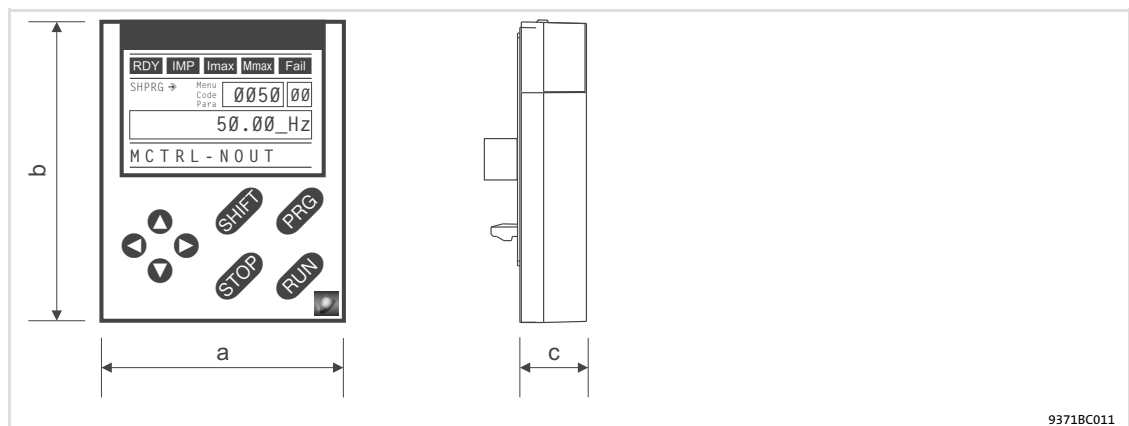

Feature	Values	
Dimensions		
Width	a	60 mm
Height	b	73.5 mm
Depth	c	15 mm
Environmental conditions		
Climate		
Storage	IEC/EN 60721-3-1	1K3 (-25 ... +60 °C)
Transport	IEC/EN 60721-3-2	2K3 (-25 ... +70 °C)
Operation	IEC/EN 60721-3-3	3K3 (-10 ... +60 °C)
Enclosure	IP 20	

3.1.2 Installation and commissioning

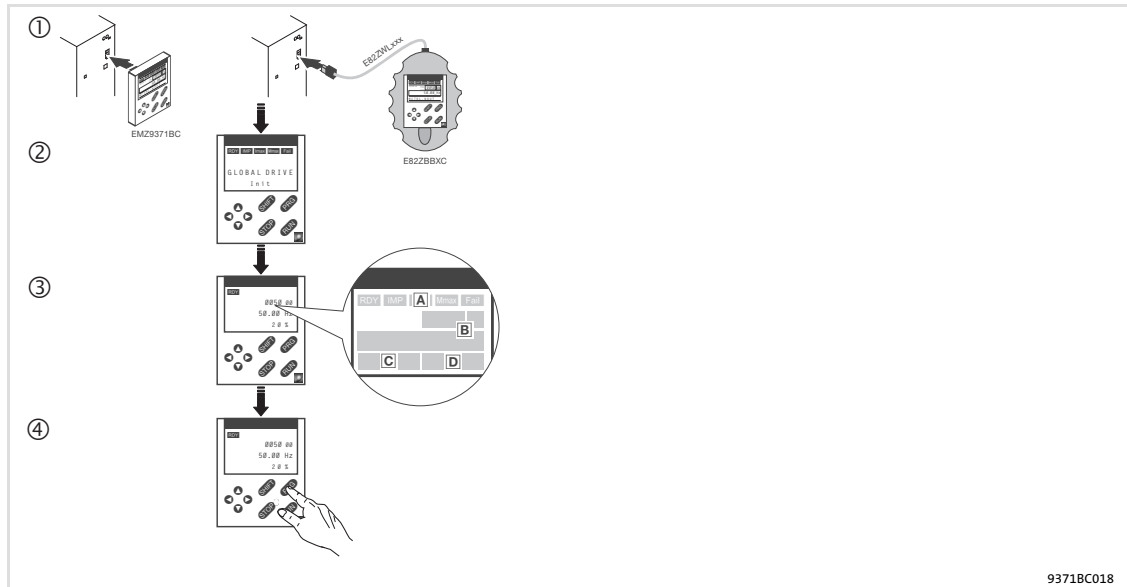

Fig. 3-1 Installation and commissioning of XT EMZ9371BC keypad or E82ZBBXC diagnosis terminal

- ① Connect keypad to the AIF interface on the front of the standard device.
The keypad can be connected/disconnected during operation.
- ② As soon as the keypad is supplied with voltage, it carries out a short self-test.
- ③ The operation level indicates when the keypad is ready for operation:
 - Ⓐ Current state of the standard device
 - Ⓑ Memory location 1 of the user menu (C0517):
Code number, subcode number, and current value
 - Ⓒ Active fault message or additional status message
 - Ⓓ Actual value in % of the status display defined in C0004
- ④ **PRG** must be pressed to leave the operation level

3.1.3 Display elements and function keys

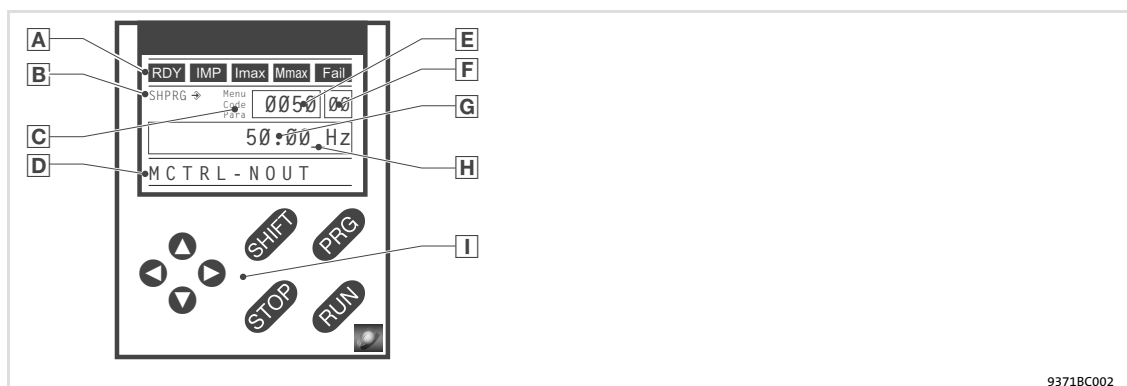

Fig. 3-2 Display elements and function keys of the XT EMZ9371BC keypad

Parameter setting

Parameter setting with the XT EMZ9371BC keypad
Display elements and function keys

Displays

A Status displays of standard device		
Display	Meaning	Explanation
RDY	Ready for operation	
IMP	Pulse inhibit is active	Power outputs are inhibited
Imax	The set current limit is exceeded in motor or generator mode	
Mmax	Speed controller 1 in the limitation	Drive is torque-controlled (Only active for operation with standard devices of the 9300 series)
Fail	Active fault	
B Acceptance of the parameters		
Display	Meaning	Explanation
↔	Parameter is accepted immediately	Standard device operates immediately with the new parameter value
SHPRG ↔	Parameter must be acknowledged with SHIFT PRG	Standard device operates with the new parameter value after being acknowledged
SHPRG	Parameter must be acknowledged in case of controller inhibit SHIFT PRG	Standard device operates with the new parameter value after the controller is enabled again
None	Display parameter	Change is not possible
C Active level		
Display	Meaning	Explanation
Menu	Menu level is active	Select main menu and submenus
Code	Code level is active	Select codes and subcodes
Para	Parameter level is active	Change parameters in the codes or subcodes
None	Operating level is active	Display operating parameters
D Short text		
Display	Meaning	Explanation
alphanumeric	Contents of the menus, meaning of the codes and parameters	
	In the operating level display of C0004 in % and the active fault	
E Number		
Active level	Meaning	Explanation
Menu level	Menu number	Display is only active for operation with standard devices of the 8200 vector or 8200 motec series
Code level	Four-digit code number	
F Number		
Active level	Meaning	Explanation
Menu level	Submenu number	Display is only active for operation with standard devices of the 8200 vector or 8200 motec series
Code level	Two-digit subcode number	
G Parameter value		
	Parameter value with unit	
H Cursor		
	In the parameter level, the digit above the cursor can be directly changed	
I Function keys		
	For description see the following table	

Function keys



Note!

Shortcuts with **SHIFT**:

Press and hold **SHIFT**, then press the second key in addition.

Key	Function			
	Menu level	Code level	Parameter level	Operating level
PRG		Change to the parameter level	Change to the operating level	Change to the code level
SHIFT PRG	Go to the "Short setup" menu and load predefined configurations ¹⁾		Accept parameters when SHPRG ⇌ or SHPRG is displayed	
▲ ▼	Change between menu items	Change of code number	Change of digit via cursor	
SHIFT ▲ SHIFT ▼	Quick change between menu items	Quick change of code number	Quick change of digit via cursor	
▶ ◀	Change between main menu, submenu and code level		Cursor to the right Cursor to the left	
RUN	Deactivate the function of the key STOP , the LED in the key goes off			
STOP	Inhibit the controller, the LED in the key is lit.			
	Reset fault (TRIP-Reset): 1. Remove the cause of malfunction 2. Press STOP 3. Press RUN			

¹⁾ Only active for operation with standard devices of the 8200 vector or 8200 motec series

3.1.4 Changing and saving parameters



Note!

Your settings have an effect on the current parameters in the main memory. You must save your settings in a parameter set so that they are not lost when the mains are connected.

If you only need one parameter set, save your settings as parameter set 1, since parameter set 1 is loaded automatically after mains connection.

Step		Key sequence	Action
1.	Select the menu	▲▼▶◀	Use the arrow keys to select the desired menu
2.	Change to the code level	▶	Display of the first code in the menu
3.	Select code or subcode	▲▼	Display of the current parameter value
4.	Change to the parameter level	PRG	
5.	When SHPRG is displayed, inhibit the controller	STOP ¹⁾	The drive coasts
6.	Change parameter	A ▶◀	Move cursor below the digit to be changed
		B ▲▼	Change of digit
		SHIFT ▼	Quick change of digit
		SHIFT ▲	

Parameter setting

Parameter setting with the XT EMZ9371BC keypad
Changing and saving parameters

Step	Key sequence	Action	
7. Accept the changed parameter	Display of SHPRG or SHPRG ⇨	SHIFT PRG	
	Display ⇨	-	
8. Enable the controller, if required	RUN ¹⁾	The drive runs again	
9. Change to the code level	A	PRG	
	B	PRG	
10. Change further parameters		Restart the "loop" with step 1. or 3.	
11. Save changed parameters	A	▲▼▶◀	
	B	PRG	
	Select the parameter set in which the parameters are to be saved permanently	C	▲
D	SHIFT PRG		
12. Change to the code level	A	PRG	
	B	PRG	
13. Set parameters for another parameter set		Restart the "loop" with step 1. or 3.	

- ¹⁾ The function of the STOP key can be programmed:
C0469 = 1: Controller inhibit
C0469 = 2: Quick stop (Lenze setting)

3.1.5 Loading a parameter set

The keypad serves to load a saved parameter set into the main memory when the controller is inhibited. After the controller is enabled, it operates with the new parameters.



Danger!

- ▶ When a new parameter set is loaded, the controller is reinitialised and acts as if it had been connected to the mains:
 - System configurations and terminal assignments can be changed. Make sure that your wiring and drive configuration comply with the settings of the parameter set.
- ▶ Only use terminal X5/28 as source for the controller inhibit! Otherwise the drive may start in an uncontrolled way when switching over to another parameter set.



Note!

- ▶ After switching on the supply voltage, the controller always loads parameter set 1 into the main memory.
- ▶ It is also possible to load other parameter sets into the main memory via the digital inputs or bus commands.

Step		Key sequence	Action
1.	Inhibit controller		Terminal X5/28 = LOW
2.	Load the saved parameter set into the main memory		
		A	Select the code C0002 "PAR LOAD" in the menu "Load/Store"
		B	Change to the parameter level The active parameter set is displayed, e. g. display "0" and "Load Default" If you want to restore the delivery status, proceed with D
	Select the parameter set to be loaded	C	Load parameter set 1: ⇒ Set "1" "Load PS1"
			Load parameter set 2: ⇒ Set "2" "Load PS2"
			Load parameter set 3: ⇒ Set "3" "Load PS3"
			Load parameter set 4: ⇒ Set "4" "Load PS4"
		D	"RDY" goes off. The parameter set is loaded completely into the main memory if "RDY" is displayed again.
3.	Change to the code level		
		A	Display of the operating level
		B	Display of C0002 "PAR LOAD"
4.	Enable controller		Terminal X5/28 = HIGH The drive is running with the settings of the loaded parameter set

Parameter setting

Parameter setting with the XT EMZ9371BC keypad
Transferring parameters to other standard devices

3.1.6 Transferring parameters to other standard devices

Parameter settings can be easily copied from one standard device to another by using the keypad.

For this purpose use the "Load/Store" menu



Danger!

During the parameter transfer from the keypad to the standard device the control terminals can adopt undefined states!

Therefore the plugs X5 and X6 must be disconnected from the standard device before the transfer takes place. This ensures that the controller is inhibited and all control terminals have the defined state "LOW".

Copying parameter sets from the standard device into the keypad



Note!

After copying the parameter sets into the XT keypad (C0003 = 11), always the parameter set that was loaded last via C0002 is activated.

Like this the current parameters also remain active after copying:

- ▶ Save the current parameters in the parameter set before copying and load this parameter set in the controller via C0002.

Step	Key sequence	Action
1.	Connect the keypad to standard device 1	
2.	Inhibit controller	Terminal X5/28 = LOW The drive coasts.
3.	Select C0003 in the "Load/Store" menu	●●●●● Select code C0003 "PAR SAVE" in the "Load/Store" menu using the arrow keys.
4.	Change to the parameter level	PRG Display "0" and "READY"
5.	Copy all parameter set into the keypad	The settings saved in the keypad are overwritten. ● Set "11" "Save extern"
6.	Start copying	SHIFT PRG The "RDY" status display goes off. As parameter value "BUSY" is displayed. If "BUSY" goes off after approx. one minute, all parameter sets were copied into the keypad. The "RDY" status display is lit.
7.	Change to the code level	A PRG B PRG Display of the operating level Display C0003 and "PAR SAVE"
8.	Enable controller	Terminal X5/28 = HIGH
9.	Remove keypad from standard device 1	

Copying parameter sets from keypad into the standard device

Step	Key sequence	Action
1.		Connect the keypad to standard device 2
2.		Inhibit controller Terminal X5/28 = LOW The "IMP" status display is lit. The drive coasts
3.		Pull the plugs X5 and X6 All control terminals have the defined "LOW" status.
4.	▲▼◀▶	Select C0002 in the "Load/Store" menu Select code C0002 "PAR LOAD" in the "Load/Store" menu using the arrow keys.
5.	PRG	Change to the parameter level The active parameter set is shown, e. g. display "0" and "Load Default"
6.		Select the correct copy function The settings saved in the standard device are overwritten.
	●	<ul style="list-style-type: none"> Copy all parameter sets available into the EEPROM of the standard device and save them permanently. The parameter set that was active before copying is overwritten. The parameters are not yet active after copying. Select parameter set and load it in the main memory. ◀ 25
	●	Set "20" "ext -> EEPROM"
	●	Copy individual parameter sets into the main memory of the standard device.
	●	Copy parameter set 1 into the main memory: Set ⇒ "11" "Load ext PS1"
		Copy parameter set 2 into the main memory: Set ⇒ "12" "Load ext PS2"
		Copy parameter set 3 into the main memory: Set ⇒ "13" "Load ext PS3"
		Copy parameter set 4 into the main memory: Set ⇒ "14" "Load ext PS4"
7.	SHIFT PRG	Start copying The "RDY" status display goes off. As parameter value "BUSY" is displayed. If "BUSY" goes off, the parameter sets selected were copied into the standard device. The "RDY" status display is lit.
8.	A	Change to the code level Display of the operating level
	B	Display C0002 and "PAR LOAD"
9.	▲▼◀▶	<ul style="list-style-type: none"> If the function "Copy all parameter sets into the EEPROM" (C0002 = 20) is selected, they might have to be loaded in the main memory manually. If the function "Copy individual parameter sets into the main memory" (C0002 = 1x) is selected, they might have to be saved permanently in the EEPROM manually.
10.		Plug in plugs X5 and X6
11.		Enable controller Terminal X5/28 = HIGH The drive is running with the new settings.

3.1.7 Activating password protection

**Note!**

- ▶ If the password protection is activated (C0094 = 1 ... 9999), you only have free access to the user menu.
- ▶ To access the other menus, you must enter the password. By this, the password protection is annulled until you enter a new password.
- ▶ Please observe that the password-protected parameters can be overwritten as well when transferring the parameter sets to other standard devices. The password is not transferred.
- ▶ Do not forget your password! If you have forgotten your password, it can only be reset via a PC or a bus system!

Activate password protection

Step	Key sequence	Action
1. Select the "USER menu"	⬅️⬅️⬅️⬅️	Change to the user menu using the arrow keys
2. Change to the code level	➡️	Display of code C0051 "MCTRL-NACT"
3. Select C0094	⬆️	Display of code C0094 "Password"
4. Change to the parameter level	PRG	Display "0" = no password protection
5. Set password		
	A ⬆️	Select password (1 ... 9999)
	B SHIFT PRG	Confirm password
6. Change to the code level		
	A PRG	Display of the operating level
	B PRG	Display of C0094 and "Password"
7. Change to the "USER menu"	⬅️⬅️⬅️	

The password protection is active now.

You can only quit the user menu if you re-enter the password and confirm it with SHIFT PRG.

Remove password protection

Step	Key sequence	Action
1. Change to the code level in the user menu	➡️	
2. Select C0094	⬆️	Display of code C0094 "Password"
3. Change to the parameter level	PRG	Display "9999" = password protection is active
4. Enter password		
	A ⬆️	Set valid password
	B SHIFT PRG	Confirm The password protection is deactivated by entering the password once again.
5. Change to the code level		
	A PRG	Display of the operating level
	B PRG	Display of C0094 and "Password"

The password protection is deactivated now. All menus can be freely accessed again.

3.1.8 Diagnostics

In the "Diagnostic" menu the two submenus "Actual info" and "History" contain all codes for

- ▶ monitoring the drive
- ▶ fault/error diagnosis

In the operating level, more status messages are displayed. If several status messages are active, the message with the highest priority is displayed.

Priority	Display	Meaning
1	GLOBAL DRIVE INIT	Initialisation or communication error between keypad and controller
2	XXX - TRIP	Active TRIP (contents of C0168/1)
3	XXX - MESSAGE	Active message (contents of C0168/1)
4	Special device states:	Switch-on inhibit
5	Source for controller inhibit (the value of C0004 is displayed simultaneously):	
	STP1	9300 servo: Terminal X5/28 ECSxS/P/M/A: Terminal X6/SI1
	STP3	Operating module or LECOM A/B/LI
	STP4	INTERBUS or PROFIBUS-DP
	STP5	9300 servo, ECSxA/E: System bus (CAN) ECSxS/P/M: MotionBus (CAN)
	STP6	C0040
6	Source for quick stop (QSP):	
	QSP-term-Ext	The MCTRL-QSP input of the MCTRL function block is on HIGH signal.
	QSP-C0135	Operating module or LECOM A/B/LI
	QSP-AIF	INTERBUS or PROFIBUS-DP
	QSP-CAN	9300 servo, ECSxA: System bus (CAN) ECSxS/P/M: MotionBus (CAN)
7	XXX - WARNING	Active warning (contents of C0168/1)
8	xxxx	Value below C0004

3.1.9 Menu structure

For simple, user-friendly operation, the codes are clearly arranged in function-related menus:

Main menu	Submenus	Description
Display	Display	
User-Menu		Codes defined in C0517
Code list		All available codes
	ALL	All available codes listed in ascending order (C0001 ... C7999)
	PS 1	Codes in parameter set 1 (C0001 ... C1999)
	PS 2	Codes in parameter set 2 (C2001 ... C3999)
	PS 3	Codes in parameter set 3 (C4001 ... C5999)
	PS 4	Codes in parameter set 4 (C6001 ... C7999)
Load/Store		Parameter set management Parameter set transfer, restore delivery status
Diagnostic		Diagnostic
	Actual info	Display codes to monitor the drive
	History	Fault analysis with history buffer
Short setup		Quick configuration of predefined applications Configuration of the user menu The predefined applications depend on the type of the standard device (frequency inverter, servo inverter, position controller, ...)
Main FB		Configuration of the main function blocks
	NSET	Setpoint processing
	NSET-JOG	Fixed setpoints
	NSET-RAMP1	Ramp function generator
	MCTRL	Motor control
	DFSET	Digital frequency processing
	DCTRL	Internal control
Terminal I/O		Connection of inputs and outputs with internal signals
	AIN1 X6.1/2	Analog input 1
	AIN2 X6.3/4	Analog input 2
	AOUT1 X6.62	Analog output 1
	AOUT2 X6.63	Analog output 2
	DIGIN	Digital inputs
	DIGOUT	Digital outputs
	DFIN	Digital frequency input
	DFOUT	Digital frequency output
	State bus	State bus (not with 9300 frequency inverter)
Controller		Configuration of internal control parameters
	Speed	Speed controller
	Current	Current controller or torque controller
	Phase	Phase controller (not with 9300 frequency inverter)
Motor/Feedb.		Input of motor data, configuration of speed feedback
	Motor adj	Motor data
	Feedback	Configuration of feedback systems
Monitoring		Configuration of monitoring functions

Main menu	Submenus	Description
Display	Display	
LECOM/AIF		Configuration of operation with communication modules
	LECOM A/B	Serial interface
	AIF interface	Process data
	Status word	Display of status words
System bus		Configuration of system bus (CAN)
	Management	CAN communication parameters
	CAN-IN1	CAN object 1
	CAN-OUT1	
	CAN-IN2	CAN object 2
	CAN-OUT2	
	CAN-IN3	CAN object 3
	CAN-OUT3	
	Status word	Display of status words
	FDO	Free digital outputs
	Diagnostic	CAN diagnostic
FB config		Configuration of function blocks
Func blocks		Parameterisation of function blocks The submenus contain all available function blocks
FCODE		Configuration of free codes
Identify		Identification
	Drive	Software version of standard device
	Op Keypad	Software version of keypad

4 Troubleshooting and fault elimination

Display of operating data, diagnostics

Display of operating data

4 Troubleshooting and fault elimination

4.1 Display of operating data, diagnostics

4.1.1 Display of operating data

Description

Important operating parameters are measured by the controller. They can be displayed with the keypad or PC.

Some operating data can be calibrated to be displayed or selected directly with the unit of the process quantity (e.g. pressure, temperature, speed).



Note!

The calibration always affects all specified codes simultaneously.

Codes for parameter setting

Code		Possible settings			IMPORTANT
No.	Name	Lenze	Selection		
C0051	MCTRL-NACT		-36000 {1 rpm}	36000	Actual speed value, function block MCTRL <ul style="list-style-type: none">● Read only
C0052	MCTRL-Umot		0 {1 V}	800	Motor voltage, function block MCTRL <ul style="list-style-type: none">● Read only● MCTRL-VACT = 100 % = C0090
C0053	UG-VOLTAGE		0 {1 V}	900	DC-bus voltage, function block MCTRL <ul style="list-style-type: none">● Read only● MCTRL-DCVOLT = 100 % = 1000 V
C0054	IMot		0.0 {0.1 A}	500.0	Current motor current, function block MCTRL <ul style="list-style-type: none">● Read only● MCTRL-IACT = 100 % = C0022
C0061	Heatsink temp		0 {1 °C}	100	Heatsink temperature <ul style="list-style-type: none">● Read only● If the temperature of the heatsink > 85 °C, the controller sets TRIP <i>DH</i>● Early warning is possible via <i>DH4</i>, temperature is set in C0122
C0063	Mot temp		0 {1 °C}	200	Motor temperature <ul style="list-style-type: none">● Read only● Monitoring of the motor temperature must be activated.● KTY at X8/5, X8/8:<ul style="list-style-type: none">– At 150 °C, TRIP <i>DH3</i> is set– Early warning is possible via <i>DH7</i>, temperature is set in C0121● PTC, thermal contact at T1, T2:<ul style="list-style-type: none">– Release sets TRIP or warning <i>DH8</i>

Code		Possible settings			IMPORTANT	
No.	Name	Lenze	Selection			
C0064	Utilization		0	{1 %}	150	Device utilisation I×t <ul style="list-style-type: none"> • Read only • Device utilisation during the last 180 s of operating time • C0064 > 100 % releases warning 005 • C0064 > 140 % limits the output current of the controller to 67 % of the maximum current in C0022
C0150	Status word		Bit00 – Bit01 IMP Bit02 – Bit03 – Bit04 – Bit05 – Bit06 n = 0 Bit07 CINH	Bit08 Status code Bit09 Status code Bit10 Status code Bit11 Status code Bit12 Warning Bit13 Message Bit14 – Bit15 –		Read only Decimal status word for networking via automation interface (AIF) <ul style="list-style-type: none"> • Binary interpretation indicates the bit states

4.1.2 Diagnostics

Description

Display codes for diagnostics

Codes for parameter setting

Code		Possible settings			IMPORTANT
No.	Name	Lenze	Selection		
C0093	DRIVE IDENT				Controller identification
					• Read only
			0	invalid	Damaged power section
			1	none	No power section
			9321	9321VC	Display of the controller used
			
	9333	9333VC			
C0099	S/W version		x.y x Main version y Subversion		Software version <ul style="list-style-type: none"> • Read only

4 Troubleshooting and fault elimination

Troubleshooting
Status display via controller LEDs

4.2 Troubleshooting

Detecting breakdowns

A breakdown can be detected quickly via the LEDs at the controller or via the status information at the keypad.

Analysing errors

Analyse the error using the history buffer. The list of fault messages gives you advice how to remove the fault. (📖 40)

4.2.1 Status display via controller LEDs

During operation the operating status of the controller is shown by 2 LEDs.

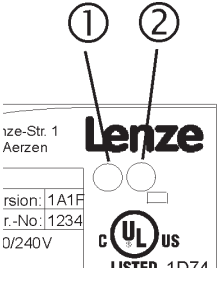
LED		Operating status	
Red ①	Green ②		
Off	On	Controller is enabled	
On	On	Mains is switched on and automatic start is inhibited	
Off	Blinking slowly	Controller is inhibited	
Off	On	Motor data identification is being performed	
Blinking quickly	Off	Undervoltage	
Blinking slowly	Off	Active fault	

4.2.2 Fault analysis with the history buffer

Retracing faults

Faults can be retraced via the history buffer. Fault messages are stored in the 8 memory locations in the order of their appearance.

The memory locations can be retrieved via codes.

Structure of the history buffer

Code			Memory location	Entry	Note
C0168/1	C0169/1	C0170/1	Memory location 1	Active fault	If the fault is no longer pending or has been acknowledged: <ul style="list-style-type: none"> • The contents of the memory locations 1 ... 7 are shifted "up" to the next memory location. • The content of memory location 8 is deleted from the history buffer and cannot be retrieved anymore. • Memory location 1 is deleted (= no active fault).
C0168/2	C0169/2	C0170/2	Memory location 2	Last fault	
C0168/3	C0169/3	C0170/3	Memory location 3	Last but one fault	
C0168/4	C0169/4	C0170/4	Memory location 4	Last but two fault	
C0168/5	C0169/5	C0170/5	Memory location 5	Last but three fault	
C0168/6	C0169/6	C0170/6	Memory location 6	Last but four fault	
C0168/7	C0169/7	C0170/7	Memory location 7	Last but five fault	
C0168/8	C0169/8	C0170/8	Memory location 8	Last but six fault	

Explanations regarding the codes

C0168	Fault indication and response <ul style="list-style-type: none"> • The entry is effected as a LECOM error number • If several faults with different responses occur at the same time: <ul style="list-style-type: none"> – Only the fault with the highest priority response is entered (1. TRIP, 2. message, 3. warning). • If several faults with the same response (e.g. 2 messages) occur at the same time: <ul style="list-style-type: none"> – Only the fault which occurred first is entered.
C0169	Time of fault occurrence <ul style="list-style-type: none"> • The reference time is provided by the power-on time meter (C0179). • If the same fault occurs several times in succession, only the time of the last occurrence is stored.
C0170	Fault frequency <ul style="list-style-type: none"> • Only the time of the last occurrence is stored.

Clear history buffer

Set C0167 = 1 to clear the history buffer.

4 Troubleshooting and fault elimination

Drive behaviour in the event of faults
Fault analysis with the history buffer

4.3 Drive behaviour in the event of faults

The controller responds differently to the three possible fault types TRIP, message, or warning:

TRIP

TRIP (display in keypad XT: )

- ▶ Switches the power outputs U, V, W to a high-resistance state until TRIP reset is executed.
- ▶ The fault indication is entered into the history buffer as "current fault" in C0168/1.
- ▶ The drive coasts without any control!
- ▶ After TRIP reset ( 45):
 - The drive travels along the ramps to its setpoint.
 - The fault indication is moved to C0168/2 as "last fault".

Messages

Message (display in keypad XT: )

- ▶ Switches the power outputs U, V, W to a high-resistance state.
- ▶ The fault indication is entered into the history buffer as "current fault" in C0168/1.
- ▶ In case of a fault ≤ 5 s:
 - The drive coasts without any control as long as the message is active!
 - If the message is not active anymore, the drive travels to its setpoint with maximum torque.
- ▶ In case of a fault > 5 s:
 - The drive coasts without any control as long as the message is active!
 - If the message is not active anymore, the drive travels to its setpoint along the adjusted ramps.
- ▶ If the message is not active anymore, the fault indication is moved to C0168/2 as "last fault".

Warnings

"Heatsink overtemperature" (keypad XT: )

- ▶ The drive continues to travel in a controlled way!
- ▶ The warning signal goes off when the fault is not active anymore.

"Error in motor phase" (keypad XT: )

"PTC monitoring" (keypad XT: )

- ▶ The drive continues to travel in a controlled way!
- ▶ The fault indication is entered into the history buffer as "current fault" in C0168/1.
- ▶ After TRIP reset, the fault indication is moved to C0168/2 as "last fault".

4.4 Fault elimination

4.4.1 Drive errors

Malfunction	Cause	Remedy
An asynchronous motor with feedback rotates in an uncontrolled manner and with low speed	<p>The motor phases are reversed so that the rotating field of the motor is not identical with the rotating field of the feedback system. The drive shows the following behaviour:</p> <ul style="list-style-type: none"> • V/f characteristic control (C0006 = 5) <ul style="list-style-type: none"> – The motor rotates faster than the speed setpoint by the value set in C0074 (influence of the speed controller, Lenze setting 10 % of n_{max}). After the controller is enabled, it does not stop at zero speed setpoint or quick stop (QSP). – The final motor current depends, among other things, on the set value of the V_{min} boost (C0016) and can rise to I_{max} (C0022). This may activate the fault message OC5. • Vector control (C0006 = 1) <ul style="list-style-type: none"> – The motor rotates slowly with maximum slip speed (depending on motor data and maximum current) and does not react to a speed setpoint. The direction of rotation, however, is determined by the sign of the speed setpoint. – The motor current rises up to I_{max} (C0022). This may activate the fault message OC5 with a time delay. 	<ul style="list-style-type: none"> • Check motor cable for correct phase relation. • If possible, operate the motor with deactivated feedback (C0025 = 1) and check the direction of rotation of the motor.
Motor does not rotate although the controller is enabled (IMP is off) and a speed setpoint has been specified.	The two terminal strips X5 are reversed. Since X5/A1 and X5/28 face each other, the controller can be enabled if the control terminals are internally supplied. All other connections, however, are assigned incorrectly so that the motor cannot start.	<p>Check the position of the terminal strips:</p> <ul style="list-style-type: none"> • If you look at the connection unit in reading direction, the left terminal strip X5 must be connected with the input signals and the right terminal strip X5 must be connected with the output signals.
The monitoring of the motor phases (LP1) does not respond if a motor phase is interrupted, although C0597 = 0 or 2	The function block MLP1 is not entered into the processing table.	Enter the function block MLP1 into the processing table. The function block MLP1 requires 30 μ s of calculating time.
If during high speeds DC-injection braking (GSB) is activated, the fault OC1 (TRIP) or OU (TRIP) occurs	During DC-injection braking the controller sets pulse inhibit for a short time (DCTRL-IMP) to reduce the magnetisation in the motor before a DC voltage is injected into the motor. At high speeds (e. g. in case of mid-frequency motors) the residual voltage which develops from the residual magnetism and high speed can generate such a high motor current that OC1 or OU are activated.	<p>Prolong the duration of the pulse inhibit:</p> <ul style="list-style-type: none"> • Connect the output signal DCTRL-IMP to the function block TRANSx and adjust the desired switch-off time there (usually 500 ms). If DCTRL-CINH1 is set to HIGH, the duration of the pulse inhibit is prolonged by the time adjusted.

4.4.2 Controller in clamp operation

The clamp operation is a permissible operating mode. But since, however, pulse inhibit is set again and again, the controller cannot provide the optimum power.

If the output power is optimal, the output current mainly is right below the clamp threshold.

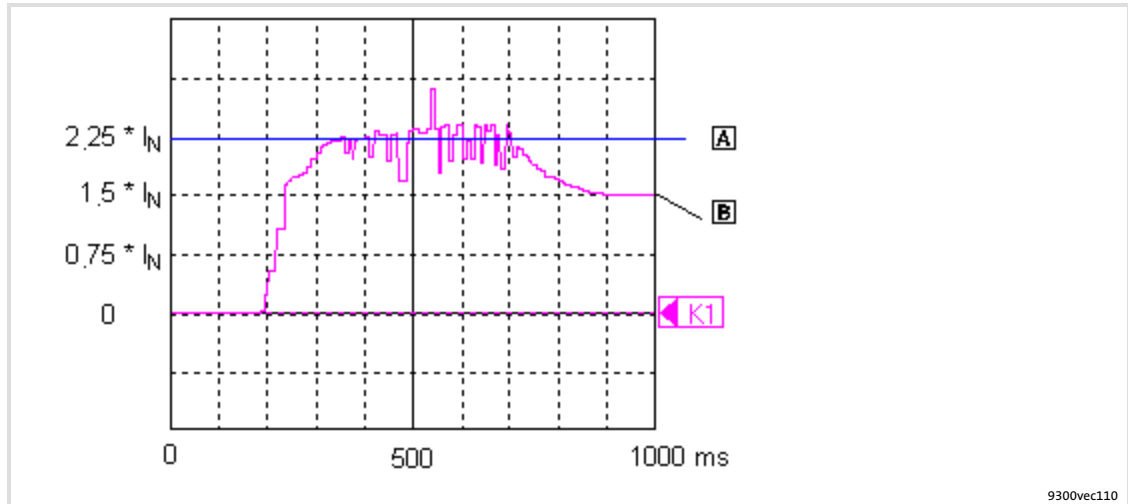

Fig. 4-1 Output current when starting a motor with high load (shown with the oscilloscope in GDC)

- Ⓐ Clamp threshold
- Ⓑ Output current

Function

1. When the output current reaches $2.25 \times I_r$, a software clamp is activated.
2. The controller sets pulse inhibit for a short time. The motor current decreases as a function of the inductance in the motor circuit.
 - An internal counter is increased by the value one.
3. After max. 250 μ s the pulse inhibit is deactivated.
4. If a software clamp reoccurs within 2 s, the internal counter is again increased by the value one. Otherwise the counter is set to zero.
 - If the counter reaches the value 4300, OC3 (TRIP) is activated.

4.4.3 Behaviour in case of overvoltage in the DC bus (OU message)

Description

If the DC-bus voltage (U_{DC}) exceeds the switch-off threshold OU, the pulse inhibit is set. At the same time, an internal timing element starts for a delay time (C0912).

The pulse inhibit is deactivated if the voltage falls below the switch-on threshold OU and the delay time has elapsed.

Switching thresholds in case of overvoltage in the DC bus (OU):

Mains voltage range		C0173	Switch-off threshold OU	Switch-on threshold OU
< 400 V	Operation with / without brake chopper	0	770 V	755 V
400 V	Operation with / without brake chopper	1 *	770 V	755 V
460 V	Operation with / without brake chopper	2	770 V	755 V
480 V	Operation without brake chopper	3	770 V	755 V
480 V	Operation with brake chopper	4	800 V	785 V

* Lenze setting

Codes for parameter setting

Code		Possible settings		IMPORTANT
No.	Name	Lenze	Selection	
C0912	OV delay time	→	- {1 ms}	- Delay time of the pulse enable after an OU message → Depending on C0082, C0086, C0087, C0088, C0089, C0090, C0091, C0092 A change of one of the codes resets C0912 to the time of the selected motor ● The time is derived from the double rotor time constant

Adjustment

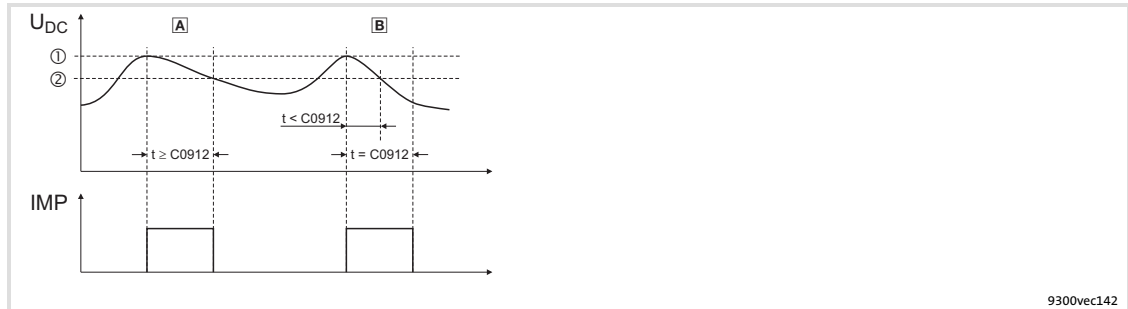

Fig. 4-2 Influence of the delay time (C0912)

① Switch-off threshold OU

② Switch-on threshold OU

A The period of time between exceeding the switch-off threshold OU and undershooting the switch-on threshold OU equals or is higher than the delay time set in C0912.

After undershooting the switch-on threshold OU, the pulse inhibit is deactivated.

B The period of time between exceeding the switch-off threshold OU and undershooting the switch-on threshold OU is lower than the delay time set in C0912.

The pulse inhibit is deactivated after the delay time in C0912 has elapsed.

- ▶ The delay time in [ms] is set under C0912. The Lenze setting can be changed by the factor 0.5 ... 2.

4.5 System error messages

4.5.1 General error messages



Note!

In the case of a query via system bus (CAN), the fault messages are represented as numbers (see first column of the table).

Fault message		Description	Cause	Remedy
No.	Display			
---	---	No fault	-	-
0011	OC1	Overcurrent in motor cable ($I_a > 2.25 \times I_N$; Hardware monitoring)	In the event of a short circuit	<ul style="list-style-type: none"> Search for the cause of the short circuit. Check the motor cable.
			Capacitive charging current of the motor cable is too high	Use motor cable which is shorter or of lower capacitance
			Too short acceleration or deceleration times in proportion to the load (C0012, C0013, C0105)	<ul style="list-style-type: none"> Increase the gain (P component) of the I_{max} controller (C0075). Reduce integral-action time (integral action component) of the I_{max} controller (C0076)
			The drive is connected to the coasting machine. The coasting is caused by a short-time pulse inhibit, e.g. at <ul style="list-style-type: none"> OU (overvoltage in the DC bus) external or internal controller inhibit 	<ul style="list-style-type: none"> Activate flying restart circuit
			<ul style="list-style-type: none"> Encoder error Tracks during encoder feedback of the motor speed are interchanged 	Check wiring of the encoder
			DC-injection braking at high speeds	<ul style="list-style-type: none"> See 37
			Missing mains phase	<ul style="list-style-type: none"> Check the connections and the supply cable of the device Check mains voltage
0012	OC2	Motor cable earth fault	One of the motor phases has earth contact.	<ul style="list-style-type: none"> Search for cause of short circuit. Check motor cable.
0013	OC3	Overload during acceleration.	Too short acceleration or deceleration times in proportion to the load (C0012, C0013, C0105).	<ul style="list-style-type: none"> Increase the gain (P component) of the current controller (C0075). Reduce the reset time (integral action component) of the I_{max} controller (C0076). Increase ramp times. 38, "controller in clamp operation (fault OC3)"
0015	OC5	$I \times t$ overload	<ul style="list-style-type: none"> Frequent and too long acceleration with overcurrent Continuous overload with $I_{motor} > 1.05 \times I_{rx}$. 	Check drive dimensioning.
0016	OC6	$I^2 \times t$ overload	<ul style="list-style-type: none"> Frequent and too long acceleration processes with motor overcurrent. Permanent motor overload with $I_{motor} > I_{r_{motor}}$ 	Check drive dimensioning.
x018	OC8	$I^2 \times t$ overload advance warning	<ul style="list-style-type: none"> Frequent and too long acceleration processes with motor overcurrent. Permanent motor overload with $I_{motor} > I_{r_{motor}}$ 	Check drive dimensioning.
2020	OU	Overvoltage in the DC bus	Braking energy is too high. (DC-bus voltage is higher than set in C0173.)	<ul style="list-style-type: none"> Use a braking unit or regenerative module. Check dimensioning of the brake resistor.
1030	LU	Undervoltage in the DC bus	DC bus voltage is lower than specified in C0173.	<ul style="list-style-type: none"> Check mains voltage Check supply cable

4

Troubleshooting and fault elimination

System error messages

General error messages

Fault message		Description	Cause	Remedy
No.	Display			
x032	LP1	Motor phase failure	A current-carrying motor phase has failed.	<ul style="list-style-type: none"> ● Check motor. ● Check motor cable. ● Switch off monitoring (C0597 = 3).
			The current limit value is set too low.	<ul style="list-style-type: none"> ● Set higher current limit value via C0599.
0050	OH	Heatsink temperature > +90 °C	Ambient temperature $T_u > +40\text{ °C}$ or $> +50\text{ °C}$	<ul style="list-style-type: none"> ● Allow module to cool and ensure better ventilation. ● Check ambient temperature in the control cabinet.
			Heatsink is very dirty.	Clean heatsink.
			Wrong mounting position	Change mounting position.
x053	OH3	Motor temperature > +150 °C threshold (temperature detection via resolver or incremental value encoder)	Motor is thermally overloaded due to: <ul style="list-style-type: none"> ● Impermissible continuous current ● Frequent or too long acceleration processes 	<ul style="list-style-type: none"> ● Check drive dimensioning. ● Switch off monitoring (C0583 = 3).
			No PTC/temperature contact connected.	Correct wiring.
x054	OH4	Heatsink temperature > C0122	Ambient temperature $T_u > +40\text{ °C}$ or $> +50\text{ °C}$	<ul style="list-style-type: none"> ● Allow module to cool and ensure better ventilation. ● Check ambient temperature in the control cabinet. ● Switch off monitoring (C0582 = 3).
			Heatsink is very dirty.	Clean heatsink
			Wrong mounting position	Change mounting position.
			The value specified under C0122 is set too low.	Enter a higher value under C0122.
x057	OH7	Motor temperature > C0121 (temperature detection via resolver or incremental value encoder)	Motor is thermally overloaded due to: <ul style="list-style-type: none"> ● Impermissible continuous current ● Frequent or too long acceleration processes 	<ul style="list-style-type: none"> ● Check drive dimensioning. ● Switch off monitoring (C0584 = 3).
			No PTC/temperature contact connected.	Correct wiring.
			The value specified under C0121 is set too low.	Enter a higher value in C0121.
x058	OH8	Motor temperature via inputs T1 and T2 is too high.	Motor is thermally overloaded due to: <ul style="list-style-type: none"> ● Impermissible continuous current ● Frequent or too long acceleration processes 	<ul style="list-style-type: none"> ● Check drive dimensioning. ● Switch off monitoring (C0585 = 3).
			Terminals T1 and T2 are not connected	Connect PTC/temperature contact.
x061	CE0	Automation interface (AIF) communication error	Faulty transfer of control commands via AIF.	<ul style="list-style-type: none"> ● Plug in the communication module/keypad XT firmly, screw down, if necessary. ● Switch off monitoring (C0126 = 3).

Fault message		Description	Cause	Remedy
No.	Display			
x062	CE1	Communication error on the process data input object CAN1_IN	CAN1_IN object receives faulty data or communication is interrupted.	<ul style="list-style-type: none"> • Check wiring at X4. • Check sender. • Increase monitoring time under C0357/1, if necessary. • Switch off monitoring (C0591 = 3).
x063	CE2	Communication error on the process data input object CAN2_IN	CAN2_IN object receives faulty data or communication is interrupted.	<ul style="list-style-type: none"> • Check wiring at X4. • Check sender. • Increase monitoring time under C0357/2, if necessary. • Switch off monitoring (C0592 = 3).
x064	CE3	Communication error on the process data input object CAN3_IN	CAN3_IN object receives faulty data or communication is interrupted.	<ul style="list-style-type: none"> • Check wiring at X4. • Check sender. • Increase monitoring time under C0357/3, if necessary. • Switch off monitoring (C0593 = 3).
x065	CE4	BUS-OFF state of system bus (CAN)	The controller has received too many faulty telegrams via the system bus (CAN) and has disconnected from the bus.	<ul style="list-style-type: none"> • Check wiring at X4: Is the bus correctly terminated? • Check shield connection of the cables. • Check PE connection. • Check bus load, reduce the baud rate if necessary. (Observe the cable length!) • Switch off the monitoring (C0595 = 3).
0071	CCr	System failure	Strong interference injection on the control cables	Screen control cables
			Ground or earth loops in the wiring	<ul style="list-style-type: none"> • Check wiring • Check PE connection <p>After troubleshooting: Deenergise the device completely (disconnect 24 V supply, discharge DC bus)!</p>
0072	PR1	Checksum error in parameter set 1 CAUTION: The Lenze setting is loaded automatically!	<ul style="list-style-type: none"> • Fault when loading a parameter set. • Interruption while transmitting the parameter set via keypad. 	<ul style="list-style-type: none"> • Set the required parameters and store them under C0003 = 1. • As to PLC devices, check the use of pointers.
			The stored parameters are incompatible with the loaded software version.	Store the parameter set under C0003 = 1 first to allow for a faults reset.
0073	PR2	Checksum error in parameter set 2 PLEASE NOTE: The Lenze setting is loaded automatically!	<ul style="list-style-type: none"> • Fault while loading a parameter set. • Interruption during the transfer of the parameter set via keypad. 	<ul style="list-style-type: none"> • Set the required parameters and save them with C0003 = 2.
			The parameters saved do not comply with the software version loaded.	In order to be able to acknowledge the error, first save the parameter set with C0003 = 2.

4 Troubleshooting and fault elimination

System error messages General error messages

Fault message		Description	Cause	Remedy
No.	Display			
0074	PEr	Program error	Error in the program flow	Send the parameter set (on floppy disk/CD-ROM) with a detailed description of the problem to Lenze. After troubleshooting: Deenergise the device completely (disconnect 24 V supply, discharge DC bus)!
0075	PR0	Error in parameter set.	The operating system software has been updated.	Storage of the Lenze setting C0003 = 1. After troubleshooting: Deenergise the device completely (disconnect 24 V supply, discharge DC bus)!
0077	PR3	Checksum error in parameter set 3 PLEASE NOTE: The Lenze setting is loaded automatically!	<ul style="list-style-type: none"> • Fault while loading a parameter set. • Interruption during the transfer of the parameter set via keypad. <p>The parameters saved do not comply with the software version loaded.</p>	<ul style="list-style-type: none"> • Set the required parameters and save them with C0003 = 3. <p>In order to be able to acknowledge the error, first save the parameter set with C0003 = 3.</p>
0078	PR4	Checksum error in parameter set 4 PLEASE NOTE: The Lenze setting is loaded automatically!	<ul style="list-style-type: none"> • Fault while loading a parameter set. • Interruption during the transfer of the parameter set via keypad. <p>The parameters saved do not comply with the software version loaded.</p>	<ul style="list-style-type: none"> • Set the required parameters and save them with C0003 = 4. <p>In order to be able to acknowledge the error, first save the parameter set with C0003 = 4.</p>
0079	PI	Fault during parameter initialisation	<ul style="list-style-type: none"> • An error has been detected during the parameter set transfer between two devices. • The parameter set does not match the controller, e.g. if data has been transferred from a higher-power controller to a lower-power controller. 	<ul style="list-style-type: none"> • Correct parameter set. • Send parameter set (on floppy disk/CD-ROM) and a detailed description of the problem to Lenze.
x083	Sd3	Encoder error at X9	<p>Cable interrupted.</p> <p>Pin X9/8 not connected.</p>	<p>Check cable for open circuit.</p> <p>Apply 5 V to pin X9/8 or switch off monitoring (C0587 = 3).</p>
x085	Sd5	Encoder error at X6/1 and X6/2 (C0034 = 1)	Current signal at X6/1 X6/2 < 2mA.	<ul style="list-style-type: none"> • Check cable for open circuit. • Check current signal encoder. • Switch off monitoring (C0598 = 3).
x086	Sd6	Motor temperature sensor error (X7 or X8)	Encoder for detecting the motor temperature at X7 or X8 indicates undefined values.	<ul style="list-style-type: none"> • Check cable for firm connection. • Switch off the monitoring (C0594 = 3).
x091	EEr	External monitoring has been triggered via DCTRL.	A digital signal assigned to the TRIP-SET function has been activated.	<ul style="list-style-type: none"> • Check external encoder. • Switch off the monitoring (C0581 = 3).
0105	H05	Internal fault (memory)		Contact Lenze.
0107	H07	Internal fault (power stage)	During initialisation of the controller, an incorrect power stage was detected.	Contact Lenze.
x110	H10	Heatsink temperature sensor error	Sensor for detecting the heatsink temperature indicates undefined values.	<ul style="list-style-type: none"> • Contact Lenze. • Switch off the monitoring (C0588 = 3).
x111	H11	Temperature sensor error: Temperature inside the controller	Sensor for detecting the internal temperature indicates undefined values.	<ul style="list-style-type: none"> • Contact Lenze. • Switch off the monitoring (C0588 = 3).



Fault message		Description	Cause	Remedy
No.	Display			
0140	ID1	Error during motor data identification.	No motor connected.	Check motor connection.
			Stator resistance too high.	Check entered motor data.
			Controller inhibited externally.	Enable controller and repeat motor data identification. The controller enable must be pending continuously until the end of the identification process.
0141	ID2	Error during motor data identification.	Motor too small.	<ul style="list-style-type: none"> Check entered motor data. For parameterisation with Global Drive Control, use the input assistant for motor data. The measurements for the inverter error characteristic and the stator resistance are correct (save measured values in C0003). For the operating mode V/f characteristic control the motor data identification can be completed.
			Controller inhibited externally.	Enable controller and repeat motor data identification. The controller enable must be pending continuously until the end of the identification process.
x200	NMAX	Maximum system speed (C0596) has been exceeded.	<ul style="list-style-type: none"> Active load (e.g. for hoists) is too high. Drive is not speed-controlled, torque is excessively limited. 	<ul style="list-style-type: none"> Check drive dimensioning. Increase torque limit, if necessary. Switch off monitoring (C0607 = 3).

Representation of the error number:

x 0 = TRIP, 1 = message, 2 = warning

E. g. "2091": An external monitoring function has triggered EEr warning

4.5.2 Resetting system error messages

Response	Measures for resetting the fault message
TRIP	 <p>Note! If a TRIP source is still active, the pending TRIP cannot be reset.</p> <p>Resetting the TRIP can be effected by:</p> <ul style="list-style-type: none"> Pressing the keypad XT EMZ9371 BC ⇒ STOP. Then press RUN to re-enable the controller. Setting code C0043 = 0. Control word C0135, bit 11 Control word AIF Control word of system bus (CAN) <p>After resetting the TRIP, the drive remains at standstill.</p>
Message	 <p>Danger! After elimination of the fault, the fault message is cancelled automatically and the drive restarts automatically.</p>
Warning	After elimination of the fault, the fault message is cancelled automatically.



© 11/2013

Lenze Automation GmbH
Postfach 10 13 52, D-31763 Hameln
Hans-Lenze-Str. 1, D-31855 Aerzen
Germany



+49 5154 82-0



+49 5154 82-2800



lenze@lenze.com



www.lenze.com

Service

Lenze Service GmbH
Breslauer Straße 3, D-32699 Extertal



Germany
008000 2446877 (24 h helpline)



+49 5154 82-1112



service@lenze.com



EDKVF93-01 ■ 13445254 ■ EN ■ 3.0 ■ TD06

10 9 8 7 6 5 4 3 2 1