

Communication Manual

## PROFIBUS-DP

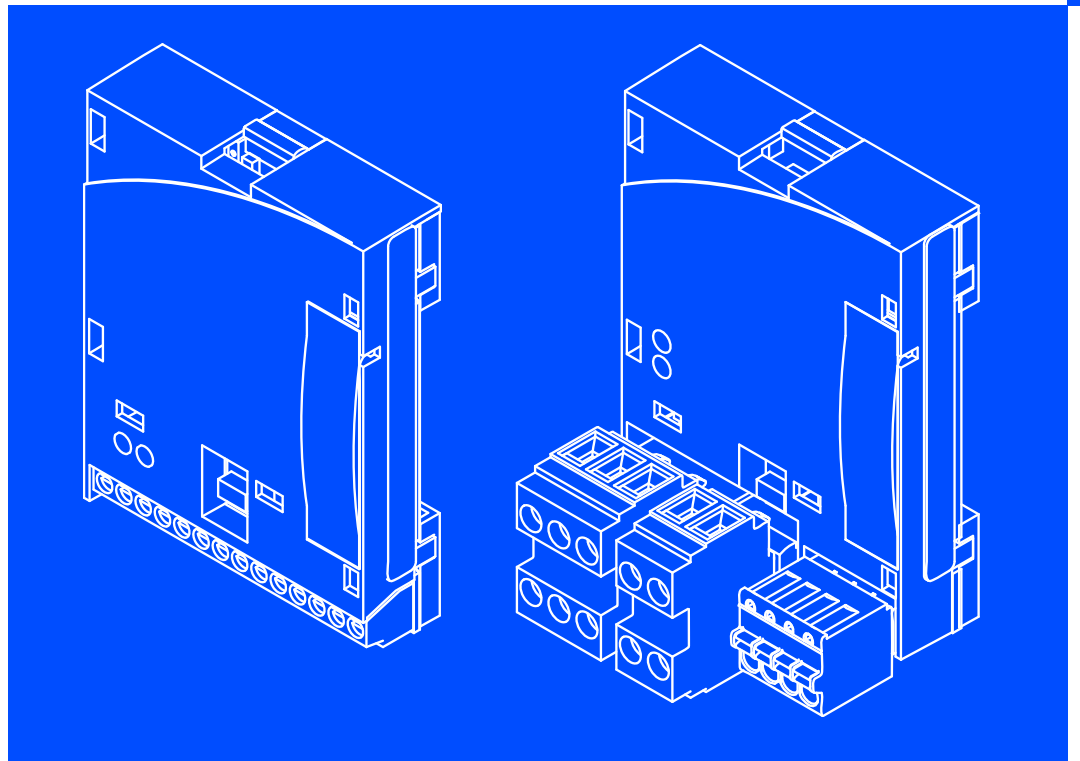

E82ZAFPC001 / E82ZAFPC010

Function module

|          |  |           |
|----------|--|-----------|
| <b>1</b> | <b>About this documentation</b> .....                      | <b>3</b>  |
| 1.1      | Document history .....                                     | 4         |
| 1.2      | Conventions used .....                                     | 5         |
| 1.3      | Terminology used .....                                     | 5         |
| 1.4      | Notes used .....   | 6         |
| <b>2</b> | <b>Safety instructions</b> .....                           | <b>7</b>  |
| 2.1      | General safety information .....                           | 7         |
| 2.2      | Device- and application-specific safety instructions ..... | 8         |
| 2.3      | Residual hazards .....                                     | 8         |
| <b>3</b> | <b>Product description</b> .....                           | <b>9</b>  |
| 3.1      | Application as directed .....                              | 9         |
| 3.2      | Identification .....                                       | 10        |
| 3.3      | Product features .....                                     | 11        |
| 3.4      | Connections and interfaces .....                           | 12        |
| <b>4</b> | <b>Technical data</b> .....                                | <b>13</b> |
| 4.1      | General data .....   | 13        |
| 4.2      | Operating conditions .....                                 | 13        |
| 4.3      | Protective insulation .....                                | 14        |
| 4.4      | Connection terminals .....                                 | 15        |
| 4.5      | Communication time .....                                   | 16        |
| 4.6      | Dimensions .....   | 17        |
| <b>5</b> | <b>Installation</b> .....                                  | <b>18</b> |
| 5.1      | Mechanical installation .....                              | 18        |
| 5.2      | Electrical installation .....                              | 19        |
| 5.2.1    | Wiring according to EMC (CE-typical drive system) .....    | 19        |
| 5.2.2    | Wiring with a host (master) .....                          | 20        |
| 5.2.3    | Voltage supply .....                                       | 23        |
| 5.2.4    | Terminal assignment .....                                  | 26        |
| 5.2.5    | Cable cross-sections and screw-tightening torques .....    | 28        |
| 5.2.6    | Use of plug connectors .....                               | 29        |
| 5.3      | Bus cable length .....                                     | 30        |

|           |   |           |
|-----------|---|-----------|
| <b>6</b>  | <b>Commissioning</b> .....                    | <b>31</b> |
| 6.1       | Before switching on .....                     | 31        |
| 6.2       | Commissioning steps .....                     | 32        |
| 6.3       | Configuring the host system (master) .....    | 34        |
| 6.3.1     | Adapting device controls .....                | 36        |
| 6.3.2     | Defining the user data length .....           | 37        |
| 6.4       | Activating the bus terminating resistor ..... | 38        |
| 6.5       | Setting the node address .....                | 39        |
| 6.6       | Connecting the mains voltage .....            | 40        |
| <b>7</b>  | <b>Process data transfer</b> .....            | <b>41</b> |
| 7.1       | Lenze device control .....                    | 42        |
| 7.1.1     | Process output data configuration .....       | 42        |
| 7.1.2     | Process input data configuration .....        | 46        |
| 7.2       | DRIVECOM control .....                        | 49        |
| 7.2.1     | DRIVECOM state machine .....                  | 49        |
| 7.2.2     | DRIVECOM control word .....                   | 50        |
| 7.2.3     | DRIVECOM status word .....                    | 51        |
| 7.2.4     | Bit control commands .....                    | 52        |
| 7.2.5     | Status bits .....                             | 53        |
| <b>8</b>  | <b>Parameter data transfer</b> .....          | <b>54</b> |
| 8.1       | DRIVECOM parameter data channel .....         | 55        |
| 8.1.1     | Addressing of the parameter data .....        | 55        |
| 8.1.2     | Addressing of the Lenze parameters .....      | 55        |
| 8.1.3     | Telegram structure .....                      | 55        |
| 8.1.4     | Error codes (DRIVECOM) .....                  | 59        |
| 8.1.5     | Reading parameters .....                      | 60        |
| 8.1.6     | Writing parameters .....                      | 62        |
| 8.2       | Parameter set transfer .....                  | 64        |
| <b>9</b>  | <b>Diagnostics</b> .....                      | <b>65</b> |
| 9.1       | LED status displays .....                     | 65        |
| 9.2       | Troubleshooting and fault elimination .....   | 66        |
| <b>10</b> | <b>Codes</b> .....                            | <b>67</b> |
| 10.1      | Overview .....                                | 67        |
| 10.2      | Communication-relevant Lenze codes .....      | 69        |
| 10.3      | Monitoring codes .....                        | 73        |
| 10.4      | Diagnostics codes .....                       | 75        |
| 10.5      | Important controller codes .....              | 82        |

|           |   |           |
|-----------|---|-----------|
| <b>11</b> | <b>Appendix</b> .....   | <b>84</b> |
|           | 11.1 Particularities for use in conjunction with Lenze standard devices ..... | 84        |
|           | 11.2 Consistent parameter data .....  | 85        |
|           | 11.3 Parallel operation of AIF and FIF interfaces .....                       | 87        |
| <b>12</b> | <b>Index</b> .....  | <b>89</b> |

# 1 About this documentation

## Contents

This documentation exclusively contains descriptions of the function modules E82ZAFPC001 (PROFIBUS-DP) and E82ZAFPC010 (PROFIBUS-DP PT).



### Note!

This documentation supplements the **mounting instructions** supplied with the function module and the **documentation for the standard devices used**.

**The mounting instructions contain safety instructions which must be observed!**

- ▶ The features and functions of the function module are described in detail.
- ▶ Typical applications are explained by means of examples.
- ▶ Moreover, this documentation contains the following:
  - Safety instructions which must be observed.
  - The essential technical data of the function module
  - Information on versions of the Lenze standard devices to be used
  - Notes on troubleshooting and fault elimination

The theoretical concepts are only explained to the level of detail required to understand the function of the function module.

Depending on the software version of the controller and the version of the »Engineer« software installed, the screenshots in this documentation may deviate from the »Engineer« representation.

This documentation does not describe any software provided by other manufacturers. No liability can be accepted for corresponding data provided in this documentation. For information on how to use the software, please refer to the host system (master) documents.

All brand names mentioned in this documentation are trademarks of their respective owners.

## Validity information

The information given in this documentation is valid for the following devices:

| Function module | Type designation | From hardware version | From software version |
|-----------------|------------------|-----------------------|-----------------------|
| PROFIBUS-DP     | E82ZAFPC001      | 3A                    | 10                    |
| PROFIBUS-DP PT  | E82ZAFPC010      | 3A                    | 10                    |

**Target group**

This documentation is intended for all persons who plan, install, commission and maintain the networking and remote service of a machine.

**Tip!**

Information and auxiliary devices related to the Lenze products can be found in the download area at

**<http://www.Lenze.com>**

**1.1****Document history**

| Material no. | Version |         |      | Description   |
|--------------|---------|---------|------|---|
| -            | 1.0     | 11/2001 | TD06 | First edition   |
| -            | 2.0     | 06/2004 | TD06 | Complete revision due to <ul style="list-style-type: none"> <li>● Layout change</li> <li>● New German orthography</li> </ul>                      |
| -            | 3.0     | 03/2005 | TD06 | General revision <ul style="list-style-type: none"> <li>● Load capacity of terminal 20</li> <li>● Structural and editorial adjustments</li> </ul> |
| 13403741     | 4.0     | 03/2012 | TD29 | General revision  |

**Your opinion is important to us!**

These instructions were created to the best of our knowledge and belief to give you the best possible support for handling our product.

If you have suggestions for improvement, please e-mail us to:



[feedback-docu@Lenze.de](mailto:feedback-docu@Lenze.de)

Thank you for your support.

Your Lenze documentation team

## 1.2 Conventions used

This documentation uses the following conventions to distinguish between different types of information:

| Type of information | Identification  | Examples/notes  |
|---------------------|---|---|
| Spelling of numbers |   |   |
| Decimal separator   | Point   | In general, the decimal point is used.<br>For instance: 1234.56   |
| Decimal             | Standard notation   | For example: 1234   |
| Hexadecimal         | 0x[0 ... 9, A ... F]  | For example: 0x60F4   |
| Binary              | In quotation marks  | For example: '100'  |
| • Nibble            | Point   | For example: '0110.0100'  |
| Text                |   |   |
| Program name        | » «   | PC software<br>For example: »Engineer«, »Global Drive Control« (GDC)  |
| Icons               |   |   |
| Page reference      |  | Reference to another page with additional information<br>For instance:  16 = see page 16 |

## 1.3 Terminology used

| Term               | Meaning   |
|--------------------|---|
| PROFIBUS           | The term stands for the <b>PROFIBUS-DP</b> variant according to IEC 61158/IEC 61784. A different PROFIBUS variant is not described in this manual.  |
| Standard device    | Lenze controllers/frequency inverters for which the function module can be used.<br> 11                                    |
| Controller         |   |
| Frequency inverter |   |
| Master             | PROFIBUS station which takes over the master function in the fieldbus system.   |
| Slave              | PROFIBUS station which acts as a slave in the fieldbus system.  |
| Code               | "Container" for one or more parameters which can be used to parameterise or monitor the controller.   |
| Subcode            | If a code contains more than one parameter, these parameters are stored in "subcodes".<br>In this documentation, a slash "/" is used as a separator when specifying a code and its subcode (e.g. "C00118/3"). |
| POW                | Process output data word  |
| PIW                | Process input data word   |

# 1 About this documentation

## Notes used

### 1.4 Notes used

The following pictographs and signal words are used in this documentation to indicate dangers and important information:

#### Safety instructions

Structure of safety instructions:





#### **Danger!**



(characterises the type and severity of danger)

#### **Note**

(describes the danger and gives information about how to prevent dangerous situations)

| Pictograph and signal word  | Meaning  |
|---|--|
|  <b>Danger!</b>  | <b>Danger of personal injury through dangerous electrical voltage.</b><br>Reference to an imminent danger that may result in death or serious personal injury if the corresponding measures are not taken. |
|  <b>Danger!</b> | <b>Danger of personal injury through a general source of danger.</b><br>Reference to an imminent danger that may result in death or serious personal injury if the corresponding measures are not taken.   |
|  <b>Stop!</b>  | <b>Danger of property damage.</b><br>Reference to a possible danger that may result in property damage if the corresponding measures are not taken.  |

#### Application notes

| Pictograph and signal word   | Meaning  |
|--|--|
|  <b>Note!</b> | Important note to ensure troublefree operation |
|  <b>Tip!</b>  | Useful tip for simple handling                 |
|               | Reference to another documentation             |



## 2 Safety instructions



### Note!

It is absolutely vital that the stated safety measures are implemented in order to prevent serious injury to persons and damage to material assets.

Always keep this documentation to hand in the vicinity of the product during operation.

### 2.1 General safety information



### Danger!

Disregarding the following basic safety measures may lead to severe personal injury and damage to material assets!

- ▶ Lenze drive and automation components ...
  - ... must only be used for the intended purpose.
  - ... must never be operated if damaged.
  - ... must never be subjected to technical modifications.
  - ... must never be operated unless completely assembled.
  - ... must never be operated without the covers/guards.
  - ... can - depending on their degree of protection - have live, movable or rotating parts during or after operation. Surfaces can be hot.
- ▶ All specifications of the corresponding enclosed documentation must be observed.  
This is vital for a safe and trouble-free operation and for achieving the specified product features.  
The procedural notes and circuit details provided in this document are proposals which the user must check for suitability for his application. The manufacturer does not accept any liability for the suitability of the specified procedures and circuit proposals.
- ▶ Only qualified skilled personnel are permitted to work with or on Lenze drive and automation components.  
According to IEC 60364 or CENELEC HD 384, these are persons ...
  - ... who are familiar with the installation, assembly, commissioning and operation of the product,
  - ... possess the appropriate qualifications for their work,
  - ... and are acquainted with and can apply all the accident prevent regulations, directives and laws applicable at the place of use.

**2.2****Device- and application-specific safety instructions**

- ▶ During operation, the function module must be firmly connected to the standard device.
- ▶ With external voltage supply, always use a separate power supply unit, safely separated to EN 61800-5-1 ("SELV"/"PELV"), in every control cabinet.
- ▶ Only use cables corresponding to the given specifications (📖 24).

**Documentation for the standard device, control system, system/machine**

All other measures prescribed in this documentation must also be implemented. Observe the safety instructions and application notes stated in the documentation.

**2.3****Residual hazards****Protection of persons**

- ▶ If the controllers are used on a phase earthed mains with a rated mains voltage  $\geq 400$  V, protection against accidental contact is not ensured without implementing external measures. (See chapter "4.3", 📖 16)

**Device protection**

- ▶ The module contains electronic components that can be damaged or destroyed by electrostatic discharge.

### **3 Product description**

#### **3.1 Application as directed**

The E82ZAFPC001 function module ...

- ▶ is an accessory module for use in conjunction with the following Lenze standard devices:

| Product range      | Device designation | From hardware version |
|--------------------|--------------------|-----------------------|
| Frequency inverter | 8200 vector        | Vx14                  |
|                    | 8200 motec         | Vx14                  |
| Motor starter      | starttec           | Vx1x                  |

- ▶ is a device intended for use in industrial power systems.

**Any other use shall be deemed inappropriate!**

The E82ZAFPC010 function module ...

- ▶ is an accessory module for use in conjunction with the following Lenze standard devices:

| Product range      | Device designation | From hardware version |
|--------------------|--------------------|-----------------------|
| Frequency inverter | 8200 vector        | Vx14                  |

- ▶ is a device intended for use in industrial power systems.

**Any other use shall be deemed inappropriate!**

# 3 Product description

## Identification

### 3.2 Identification

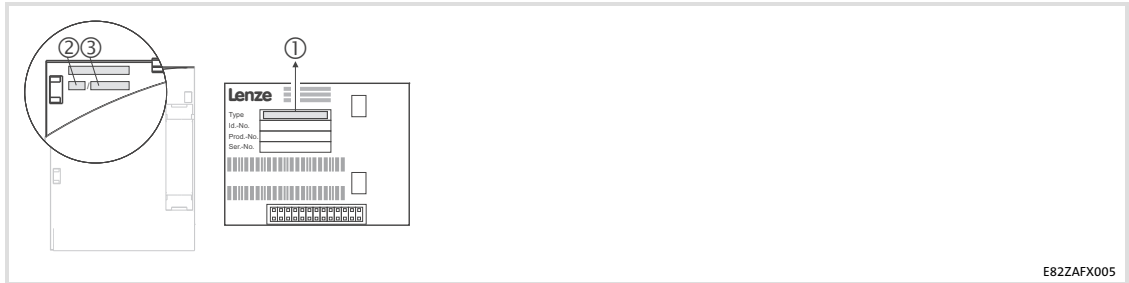

E82ZAFX005

|                    | →①            | →②       | →③       |
|--------------------|---------------|----------|----------|
| <b>Type code</b>   | <b>E82ZAF</b> | <b>P</b> | <b>C</b> |
| Device type        |               |          |          |
| PROFIBUS-DP        |               |          |          |
| Version            |               |          |          |
| Variant            |               |          |          |
| 001: Coated design |               |          |          |
| 010: PT design     |               |          |          |
| Hardware version   |               |          |          |
| Software version   |               |          |          |

### **3.3 Product features**

- ▶ Interface module for the PROFIBUS communication system which can be connected to the AIF slots of the Lenze 8200 vector, 8200 motec and starttec device series.
- ▶ Support of the PROFIBUS-DP-V0 communication profile
- ▶ Drive profile:
  - DRIVECOM profile "Drive technology 20" (can be switched off)
- ▶ Support of I&M0 functionality for standard device identification
- ▶ Automatic detection of the baud rate (9.6 kbps ... 12 Mbps)
- ▶ External 24V supply for maintaining the PROFIBUS network when the standard device fails
- ▶ DIP switch for activating the bus terminating resistor
- ▶ LED status displays:
  - Voltage supply for function module
  - Connection between the function module and the PROFIBUS network
  - Connection between the function module and the standard device

#### E82ZAFPC001 function module

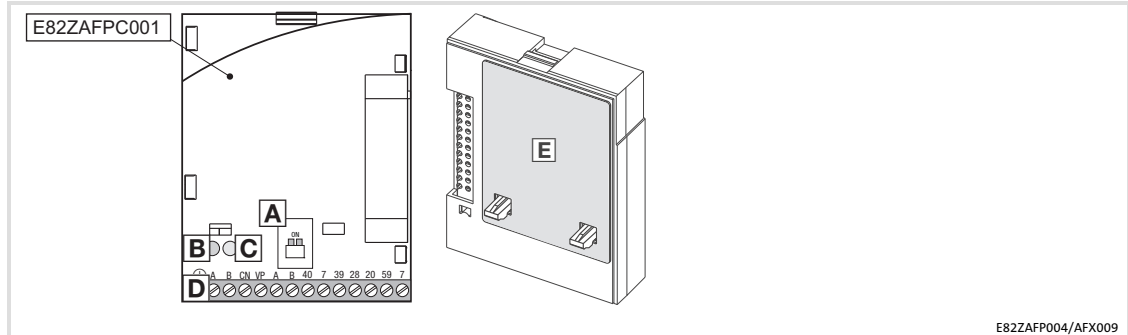

E82ZAFP004/AFX009

| Pos. | Description  | Detailed information |
|------|--|----------------------|
| A    | DIP switch for activating the bus terminating resistor   | 40                   |
| B    | Status of PROFIBUS communication (yellow LED)  | 67                   |
| C    | Connection status to the standard device (green LED)   | 28                   |
| D    | Terminal strip X3, connection for <ul style="list-style-type: none"> <li>PROFIBUS</li> <li>Controller inhibit (CINH)</li> <li>External voltage supply</li> </ul> | 12                   |
| E    | Nameplate  |                      |

#### E82ZAFPC010 function module

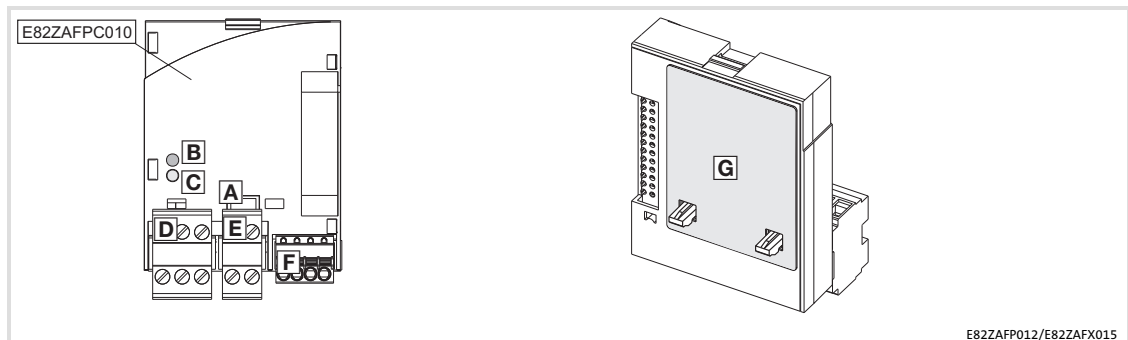

E82ZAFP012/E82ZAFX015

| Pos. | Description   | Detailed information |
|------|---|----------------------|
| A    | DIP switch for activating the bus terminating resistor        | 40                   |
| B    | Status of PROFIBUS communication (yellow LED)                 | 67                   |
| C    | Connection status to the standard device (green LED)          | 29                   |
| D    | Plug connector X3.1, connection for PROFIBUS                  |                      |
| E    | Plug connector X3.2, connection for external voltage supply   |                      |
| F    | Plug connector X3.3, connection for controller inhibit (CINH) |                      |
| G    | Nameplate   | 12                   |

## 4 Technical data

### 4.1 General data

| Field  | Values  |
|--|---|
| Order designation                                      | E82ZAFPC001 (coated)<br>E82ZAFPC010 (PT design)   |
| PUO ID number  | 0x00DA  |
| Communication profile<br>(DIN 19245 Part 1 and Part 3) | <ul style="list-style-type: none"> <li>PROFIBUS-DP-V0</li> </ul>  |
| Communication medium                                   | RS485   |
| Drive profile  | <ul style="list-style-type: none"> <li>DRIVECOM profile "Drive technology 20" (can be switched off)</li> </ul>  |
| Network topology                                       | <ul style="list-style-type: none"> <li>Without repeaters: line</li> <li>With repeaters: line or tree</li> </ul> |
| PROFIBUS stations                                      | Slave   |
| Baud rate [kbps]                                       | 9.6 ... 12000 (automatic detection)   |
| Process data words                                     | 1 ... 10 words<br>(16 bits/word)  |
| DP user data length                                    | 1 ... 10 process data words +<br>4 parameter data words   |
| Max. number of bus devices                             | <ul style="list-style-type: none"> <li>Standard: 32 (= 1 bus segment)</li> <li>With repeaters: 125</li> </ul>   |
| Max. cable length per bus<br>segment                   | 1200 m (depending on the baud rate and cable type used)   |
| External DC-voltage supply                             | +24 V DC $\pm$ 10 %, max. 80 mA   |

### 4.2 Operating conditions

| Ambient conditions   |   |                       |
|----------------------|---|-----------------------|
| Climate              |   |                       |
| Storage              | IEC/EN 60721-3-1  | 1K3 (-25 to +60 °C)   |
| Transport            | IEC/EN 60721-3-2  | 2K3 (-25 to +70 °C)   |
| Operation            | Corresponding to the data of the Lenze standard device used (see documentation of the standard device). |                       |
| Pollution            | EN 61800-5-1  | Degree of pollution 2 |
| Degree of protection | IP20 (protection against accidental contact according to NEMA 250 type 1)                               |                       |

#### 4.3 Protective insulation



### Danger!

#### Dangerous electrical voltage

If Lenze controllers are used on a phase earthed mains with a rated mains voltage  $\geq 400$  V, protection against accidental contact is not ensured without implementing external measures.

#### Possible consequences:

- ▶ Death or serious injury

#### Protective measures:

- ▶ If protection against accidental contact is required for the control terminals of the controller and the connections of the plugged device modules, ...
  - a double isolating distance must exist.
  - the components to be connected must be provided with the second isolating distance.

#### E82ZAFPC001 function module

| Protective insulation between bus and ...  | Type of insulation (according to EN 61800-5-1) |
|--|--|
| <ul style="list-style-type: none"> <li>● Power section               <ul style="list-style-type: none"> <li>– 8200 vector</li> <li>– 8200 motec</li> <li>– starttec</li> </ul> </li> </ul> | Reinforced insulation                          |
| <ul style="list-style-type: none"> <li>● Reference earth / PE (X3/7)</li> </ul>  | Reinforced insulation                          |
| <ul style="list-style-type: none"> <li>● External supply (X3/59)</li> </ul>  | Reinforced insulation                          |
| <ul style="list-style-type: none"> <li>● Terminal X3/20</li> </ul>   | Functional insulation                          |
| <ul style="list-style-type: none"> <li>● Terminal X3/28</li> </ul>   | Functional insulation                          |

#### E82ZAFPC010 function module

| Insulation between bus and ...  | Type of insulation (in accordance with EN 61800-5-1) |
|---|--|
| <ul style="list-style-type: none"> <li>● 8200 vector power stage</li> </ul>               | Reinforced insulation                                |
| <ul style="list-style-type: none"> <li>● Reference earth / PE (X3.2/7, X3.3/7)</li> </ul> | Functional insulation                                |
| <ul style="list-style-type: none"> <li>● External supply (X3.2/59)</li> </ul>             | Functional insulation                                |
| <ul style="list-style-type: none"> <li>● Supply for CINH (X3.3/20)</li> </ul>             | Functional insulation                                |
| <ul style="list-style-type: none"> <li>● Controller inhibit, CINH (X3.3/28)</li> </ul>    | Functional insulation                                |



#### 4.4 Connection terminals

##### E82ZAFPC001function module

| Terminal strip X3/ |  |
|--------------------|--|
| VP                 | Level: 5 V (reference: GND3)<br>Load capacity: $I_{\max} = 10 \text{ mA}$  |
| 28                 | External supply of terminal with<br>$U(\text{ext.}) = +12 \text{ V DC} - 0\% \dots +30 \text{ V DC} + 0\%$                                 |
| 20                 | DC voltage source for internal supply of controller inhibit (CINH)<br>$U = +20 \text{ V}$ (reference: GND1),<br>$I_{\max} = 20 \text{ mA}$ |
| 59                 | External supply of function module with<br>$U(\text{ext.}) = +24 \text{ V DC} \pm 10\%$  |

##### E82ZAFPC010 function module

| Terminal strip X3.2/ |   |
|----------------------|---|
| 59                   | External supply of function module with<br>$U(\text{ext.}) = +24 \text{ V DC} \pm 10\%$ |

| Terminal strip X3.3/ |  |
|----------------------|--|
| 28                   | External supply of terminal with<br>$U(\text{ext.}) = +12 \text{ V DC} - 0\% \dots +30 \text{ V DC} + 0\%$   |
| 20                   | DC voltage source for internal supply of controller inhibit (CINH)<br>$U = +20 \text{ V}$ (reference: GND1)<br>Load capacity: $I_{\max} = 20 \text{ mA}$ |

**4.5 Communication time**

The communication time is the time between the start of a request and the arrival of the corresponding response.

The communication times depend on ...

- ▶ the processing time in the controller
- ▶ the transmission delay time
  - the baud rate
  - the telegram length

**Processing time 8200 vector / 8200 motec / starttec**

There are no interdependencies between parameter data and process data.

- ▶ Parameter data: approx. 30 ms + 20 ms tolerance
- ▶ Process data: approx. 3 ms + 2 ms tolerance

4.6 Dimensions

E82ZAFPC001 function module

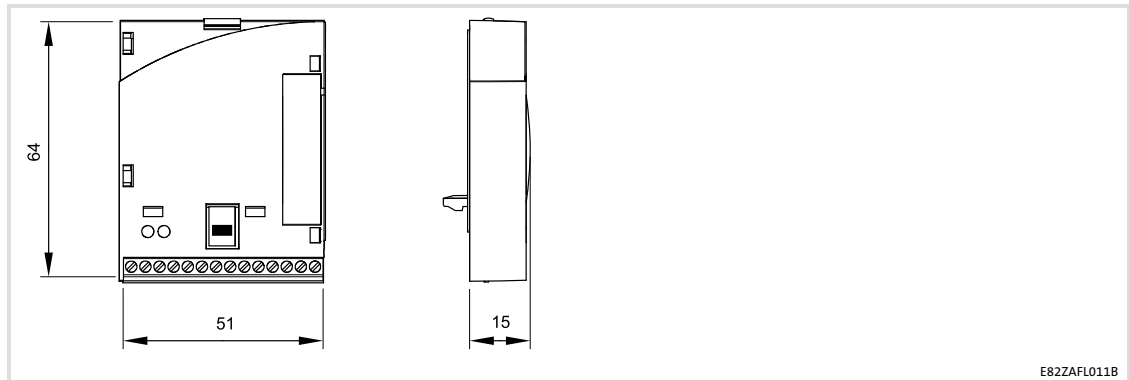

All dimensions in mm

E82ZAFPC010 function module

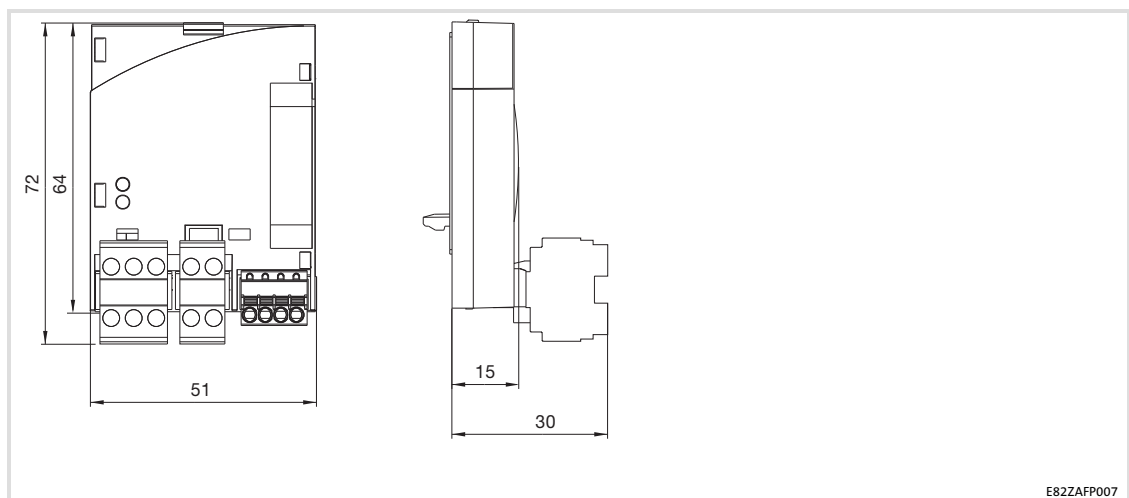

All dimensions in mm

**Danger!**

Inappropriate handling of the function module and the standard device can cause serious injuries to persons and damage to material assets.

Observe the safety instructions and residual hazards included in the documentation of the standard device.

**Stop!**

The device contains components that can be destroyed by electrostatic discharge!

Before working on the device, the personnel must ensure that they are free of electrostatic charge by using appropriate measures.

**5.1****Mechanical installation**

Follow the notes given in the Mounting Instructions for the standard device for the mechanical installation of the function module.

The Mounting Instructions for the standard device ...

- ▶ are part of the scope of supply and are enclosed with each device.
- ▶ provide tips to avoid damage provide tips to avoid damage through improper handling.
- ▶ describe the obligatory order of installation steps.

## 5.2 Electrical installation

### 5.2.1 Wiring according to EMC (CE-typical drive system)



For wiring according to EMC requirements observe the following points:



#### Note!

- ▶ Separate control cables/data lines from motor cables.
- ▶ Connect the shields of control cables/data lines *at both ends* in the case of digital signals.
- ▶ Use an equalizing conductor with a cross-section of at least 16 mm<sup>2</sup> (reference: PE) to avoid potential differences between the bus nodes.
- ▶ Observe the other notes concerning EMC-compliant wiring given in the documentation for the standard device.

#### Wiring procedure

1. Observe the bus topology, do not use any stubs.
2. Observe the notes and wiring instructions given in the documents for the control system.
3. Only use cables corresponding to the listed specifications ( 24).
4. Observe the notes for the voltage supply of the module ( 25).
5. Activate the bus terminating resistors on the first and last physical bus device ( 40).

## 5.2.2 Wiring with a host (master)

Basic design of a PROFIBUS network with RS485 cabling without repeater

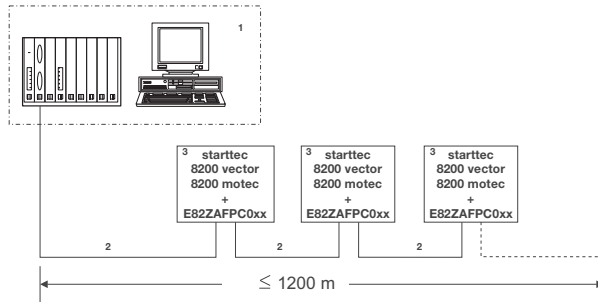

E82ZAFP005

| No. | Element        | Note  |
|-----|----------------|---|
| 1   | Host           | E.g. PC or PLC with PROFIBUS master interface module  |
| 2   | Bus cable      | Connects the PROFIBUS master interface module to the function modules. <ul style="list-style-type: none"> <li>The baud rate depends on the length of the bus cable (☞ 24).</li> </ul>   |
| 3   | PROFIBUS slave | Applicable standard device (☞ 11) with function module <ul style="list-style-type: none"> <li>Activate bus terminating resistors at the first and last physical node (☞ 40).</li> </ul> |

**Note!**

When using a repeater, max. 125 nodes can communicate via the PROFIBUS.

**Number of bus devices**

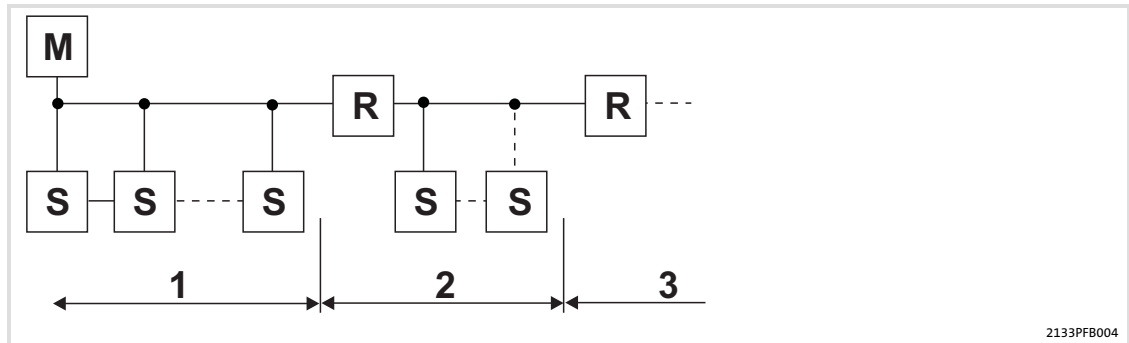

2133PFB004

| Segment | Master (M) | Slave (S) | Repeater (R) |
|---------|------------|-----------|--------------|
| 1       | 1<br>2     | 31<br>30  | -<br>-       |
| 2       | -          | 30        | 1            |
| 3       | -          | 30        | 1            |



**Tip!**

Repeaters do not have a device address. When calculating the maximum number of bus devices, they reduce the number of devices by 1 on each side of the segment.

Repeaters can be used to build up line and tree topologies. The maximum total bus system expansion depends on ...

- ▶ the baud rate used;
- ▶ the number of repeaters used.

**Specification of the transmission cable****Note!**

Only use cables complying with the listed specifications of the PROFIBUS user organisation.

| Field                       | Values                                       |
|-----------------------------|--|
| Specific resistance         | 135 ... 165 $\Omega$ /km, (f = 3 ... 20 MHz) |
| Capacitance per unit length | $\leq$ 30 nF/km                              |
| Loop resistance             | < 110 $\Omega$ /km                           |
| Core diameter               | > 0.64 mm                                    |
| Core cross-section          | > 0.34 mm <sup>2</sup>                       |
| Cores                       | Twisted double, insulated and shielded       |

**Bus cable length**

The length of the bus cable depends on the baud rate used:

| Baud rate [kbps] | Length [m] |
|------------------|------------|
| 9.6 ... 93.75    | 1200       |
| 187.5            | 1000       |
| 500              | 400        |
| 1500             | 200        |
| 3000 ... 12000   | 100        |

**Note!**

The baud rate depending on the data volume, cycle time, and number of nodes should only be selected as high as required for the application.

**Tip!**

For high baud rates we recommend to consider the use of optical fibres.

Advantages of optical fibres:

- ▶ On the transmission path external electromagnetic interference remains ineffective.
- ▶ Bus lengths of several kilometres are also possible with higher baud rates.  
The bus length
  - is irrespective of the baud rate.
  - depends on the optical fibre used.



**5.2.3 Voltage supply**

**Internal DC voltage supply**

**E82ZAFPC001 function module**

The internal voltage is provided at terminal X3/20. It serves to supply the controller inhibit (CINH).



— The min. wiring requirements for operation

**E82ZAFPC010 function module**

The internal voltage is provided at terminal X3.3/20. It serves to supply the controller inhibit (CINH).

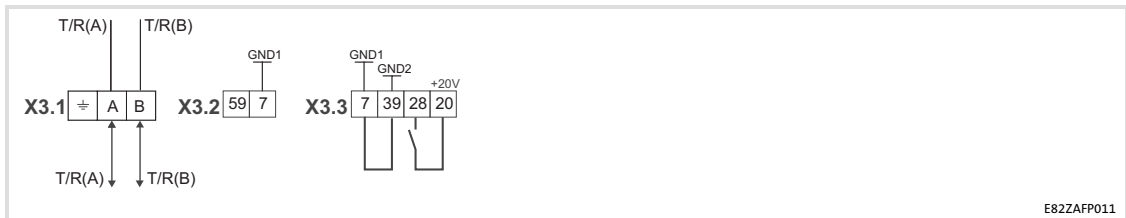

— The min. wiring requirements for operation

## External voltage supply

**Note!**

Always use a separate power supply unit in every control cabinet and safely separate it according to EN 61800-5-1 ("SELV"/"PELV") in the case of external voltage supply and larger distances between the control cabinets.

External voltage supply of the function module is required if communication via the fieldbus is to be maintained even when the power supply of the standard device fails.

**Note!**

With external voltage supply of the function module, the active bus terminating resistor is fed independently of the operation of the standard device. In this way, the bus system remains active even when the standard device is switched off or fails.

**E82ZAFPC001 function module**

External voltage supply with **one** voltage source for

- ▶ X3/28 (controller inhibit (CINH))

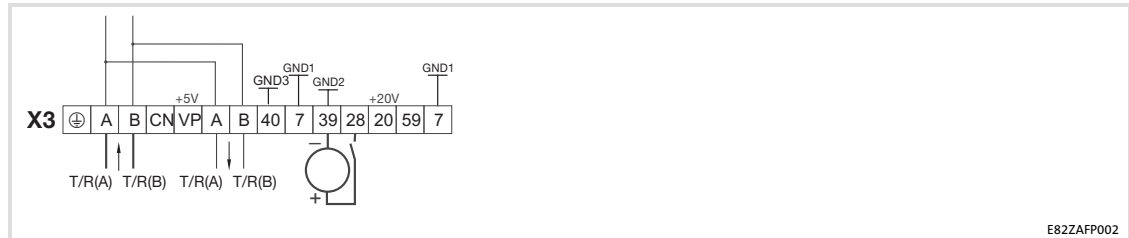

— The min. wiring requirements for operation

External voltage supply with **two** voltage sources for

1. X3/28 (controller inhibit (CINH))
2. X3/59 (function module)

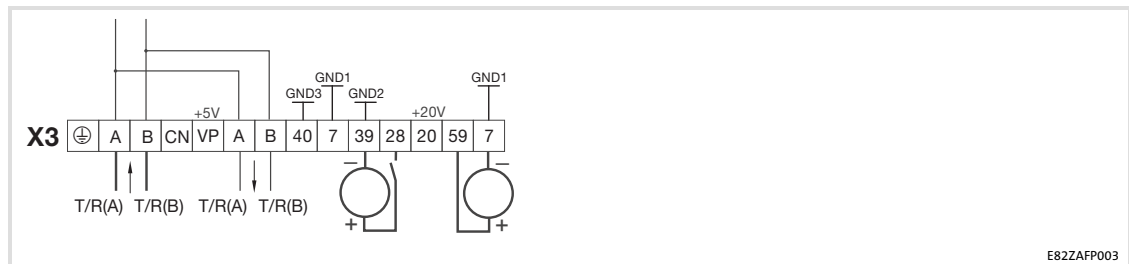

— The min. wiring requirements for operation

**E82ZAFPC010 function module**

External voltage supply with **one** voltage source for

- ▶ X3.3/28 (controller inhibit (CINH))



— The min. wiring requirements for operation

External voltage supply with **two** voltage sources for

1. X3.3/28 (controller inhibit (CINH))
2. X3.2/59 (function module)

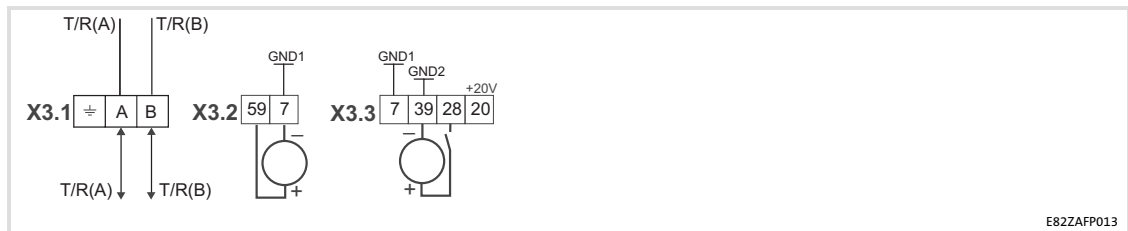

— The min. wiring requirements for operation

## 5.2.4 Terminal assignment

## E82ZAFPC001 function module

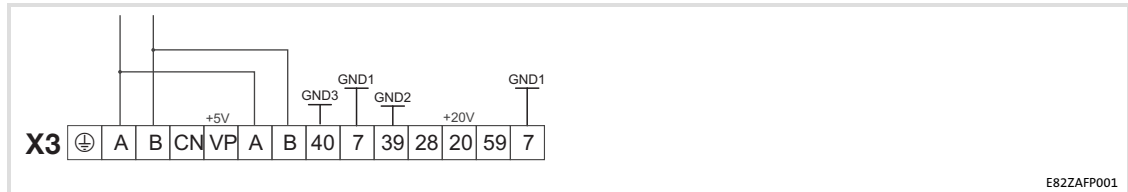

E82ZAFPC001

| Terminal X3/ | Designation | Function / level  |
|--------------|-------------|---|
| ⊕            | PES         | Additional HF-shield termination  |
| A            | T/R(A)      | RS485 data line A   |
| B            | T/R(B)      | RS485 data line B   |
| CN           | CNTR        | For function see PROFIBUS standard *)<br><ul style="list-style-type: none"> <li>Level during data transmission: CNTR = HIGH (+5 V DC, reference: GND3)</li> </ul>   |
| VP           |             | For function see PROFIBUS standard *)<br><ul style="list-style-type: none"> <li>U = +5 V DC (reference: GND3)</li> <li>I<sub>max</sub> = 10 mA</li> </ul>   |
| 40           | GND3        | Reference potential for PROFIBUS network *)   |
| 7            | GND1        | Reference potential for X3/20   |
| 39           | GND2        | Reference potential for controller inhibit (CINH) at X3/28  |
| 28           | CINH        | Controller inhibit<br><ul style="list-style-type: none"> <li>Start = HIGH (+12 ... +30 V DC)</li> <li>Stop = LOW (0 ... +3 V DC) (reference: GND2)</li> </ul>   |
| 20           |             | DC voltage source for internal supply of controller inhibit (CINH)<br><ul style="list-style-type: none"> <li>+20 V DC (reference: GND1)</li> <li>I<sub>max</sub> = 20 mA</li> </ul>   |
| 59           |             | External DC voltage supply for the function module<br><ul style="list-style-type: none"> <li>+24 V DC ± 10% (reference: GND1)</li> <li>Current consumption on 24 V DC: 80 mA</li> </ul> The current for looping through the supply voltage to other nodes via terminal 59 must be max. 3 A. |

\*) E.g. for repeater connection

**E82ZAFPC010 function module**

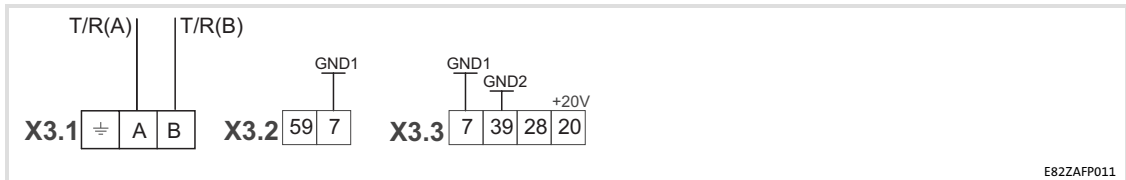



E82ZAFP011



| Terminal X3.1/ | Designation | Function / level                 |
|----------------|-------------|----------------------------------|
| ⊕              | PES         | Additional HF shield termination |
| A              | T/R(A)      | RS485 data line A                |
| B              | T/R(B)      | RS485 data line B                |



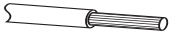
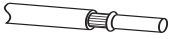

| Terminal X3.2/ | Designation | Function / level   |
|----------------|-------------|--|
| 59             |             | External DC voltage supply for the function module <ul style="list-style-type: none"> <li>• +24 V DC ± 10% (reference: GND1)</li> <li>• Current consumption on 24 V DC: 80 mA</li> </ul> The current for looping through the supply voltage to other nodes via terminal 59 must be max. 3 A. |
| 7              | GND1        | Reference potential for X3.3/20  |

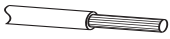
| Terminal X3.3/ | Designation | Function / level   |
|----------------|-------------|--|
| 7              | GND1        | Reference potential for X3.3/20  |
| 39             | GND2        | Reference potential for controller inhibit (CINH) at X3.3/28   |
| 28             | CINH        | Controller inhibit <ul style="list-style-type: none"> <li>• Input resistance: 3.3 kΩ</li> <li>• Start = HIGH (+12 ... +30 V)</li> <li>• Stop = LOW (0 ... +3 V) (reference: GND2)</li> </ul> |
| 20             |             | DC voltage source for external supply of controller inhibit (CINH) <ul style="list-style-type: none"> <li>• +20 V (reference: GND1)</li> <li>• I<sub>max</sub> = 10 mA</li> </ul>            |

## 5.2.5 Cable cross-sections and screw-tightening torques

| Range                 | Values   |
|-----------------------|--|
| Electrical connection | Terminal strip with screw connection   |
| Possible connections  | rigid:<br> 1.5 mm <sup>2</sup> (AWG 16)<br>flexible:<br> without wire end ferrule<br>1.0 mm <sup>2</sup> (AWG 18)<br> with wire end ferrule, without plastic sleeve<br>0.5 mm <sup>2</sup> (AWG 20)<br> with wire end ferrule, with plastic sleeve<br>0.5 mm <sup>2</sup> (AWG 20) |
| Tightening torque     | 0.22 ... 0.25 Nm (1.9 ... 2.2 lb-in)   |
| Bare end              | 5 mm   |

| Field                 | Values  |
|-----------------------|---|
| Electrical connection | Plug connector with double screw connection   |
| Possible connections  | rigid:<br> 1.5 mm <sup>2</sup> (AWG 16)<br>flexible:<br> without wire end ferrule<br>1.5 mm <sup>2</sup> (AWG 16)<br> with wire end ferrule, without plastic sleeve<br>1.5 mm <sup>2</sup> (AWG 16)<br> with wire end ferrule, with plastic sleeve<br>1.5 mm <sup>2</sup> (AWG 16) |
| Tightening torque     | 0.5 ... 0.6 Nm (4.4 ... 5.3 lb-in)  |
| Stripping length      | 10 mm   |

| Field                 | Values   |
|-----------------------|--|
| Electrical connection | 2-pin plug connector with spring connection  |
| Possible connections  | rigid:<br> 1.5 mm <sup>2</sup> (AWG 16)<br>flexible:<br> without wire end ferrule<br>1.5 mm <sup>2</sup> (AWG 16)<br> with wire end ferrule, without plastic sleeve<br>1.5 mm <sup>2</sup> (AWG 16)<br> with wire end ferrule, with plastic sleeve<br>1.5 mm <sup>2</sup> (AWG 16) |
| Stripping length      | 9 mm   |

### 5.2.6 Use of plug connectors



#### **Stop!**

Observe the following to prevent any damage to plug connectors and contacts:

- ▶ Only pug in / unplug the plug connectors when the controller is disconnected from the mains.
- ▶ Wire the plug connectors before plugging them in.
- ▶ Unused plug connectors must also be plugged in.

#### **Use of plug connectors with spring connection**

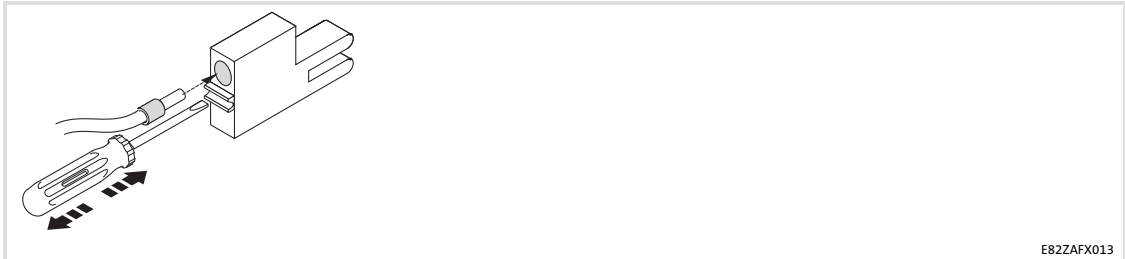

**Bus cable length****Max. possible bus cable length**

The following bus cable lengths are possible in dependence on the baud rate and the cable used:

| Baud rate [kbit/s] | Thin Cable | Thick Cable |
|--------------------|------------|-------------|
| 125                | 100 m      | 500 m       |
| 250                |            | 250 m       |
| 500                |            | 100 m       |

When using both, “Thick” and “Thin” cables, the maximum cable lengths are to be selected according to the baud rate:

| Baud rate [kbit/s] | Bus cable length  |
|--------------------|---|
| 125                | $L_{\max} = 500 \text{ m} = L_{\text{thick}} + 5 L_{\text{thin}}$   |
| 250                | $L_{\max} = 250 \text{ m} = L_{\text{thick}} + 2.5 L_{\text{thin}}$ |
| 500                | $L_{\max} = 100 \text{ m} = L_{\text{thick}} + L_{\text{thin}}$     |



## 6 Commissioning

During commissioning, system-dependent data as e.g. motor parameters, operating parameters, responses and parameters for fieldbus communication are selected for the controller.

In Lenze devices, this is done via codes. The codes are stored in numerically ascending order in the Lenze controllers and in the plugged-in communication/function modules.

In addition to these configuration codes, there are codes for diagnosing and monitoring the bus devices.

### 6.1 Before switching on



#### **Stop!**

Before switching on the standard device with the function module for the first time, check...

- ▶ the entire wiring for completeness, short circuit, and earth fault.
- ▶ whether the integrated bus terminating resistor is activated at the first and last physical node ( 40).

### 6.2 Commissioning steps



#### Note!

Do not change the setting sequence.

Step-by-step commissioning of the function module with the DRIVECOM device control is described below.

| Step | Description  | Detailed information                           |
|------|--|--|
| 1.   | Configure master system (master) for communication with the function module.   | 36   |
| 2.   | Inhibit standard device via terminal 28 (CINH). <ul style="list-style-type: none"> <li>Set terminal 28 to LOW level.</li> <li>Later the standard device can be inhibited and enabled via the bus.</li> </ul>   | Documentation of the standard device           |
| 3.   | Connect mains voltage and, if available, separate voltage supply of the function module. <ul style="list-style-type: none"> <li>The standard device will be ready for operation after approx. 1 second.</li> <li>Controller inhibit (CINH) is active.</li> </ul> <b>Response</b> <ul style="list-style-type: none"> <li>The green LED "Connection status to the standard device" at the front of the function module is lit (only visible in the case of 8200 vector).</li> <li>Keypad: <b>RDY</b> <b>IMP</b> (if plugged in)</li> </ul> | 42<br><br>67                                   |
| 4.   | Activate bus terminating resistor via DIP switch = ON for the first and last node. <ul style="list-style-type: none"> <li>Lenze setting: OFF</li> </ul>  | 40   |
| 5.   | A Set node address via ...<br>– C1509<br><br><b>After a parameter set transfer the address has to be reassigned.</b><br><br>B Switch off the voltage supply of the function module and the standard device and then switch it on again in order to accept changed settings.<br><br><b>The address that is modified via keypad becomes effective immediately.</b>   | Documentation of the standard device           |
| 6.   | Now you can communicate with the standard device, i. e. you can read all codes and adapt all writable codes to your application.<br><br><b>Response</b><br>The yellow LED on the function module is blinking when the PROFIBUS is active.  | Documentation of the standard device<br><br>67 |
| 7.   | Select function module as source for control commands and setpoints. <ul style="list-style-type: none"> <li>Set C0005 = 200. <ul style="list-style-type: none"> <li>A preconfiguration for operation with the function module is carried out.</li> <li>Control words and status words are already linked.</li> </ul> </li> </ul>   |  |
| 8.   | Assign process data output words (POW) of the master to process data input words of the standard device via C1511.<br><br><b>Lenze setting:</b><br>POW1: DRIVECOM control word (DRIVECOM CTRL)<br>POW2: Setpoint1 (NSET1-N1)<br>POW3: Setpoint2 (NSET1-N2)<br>POW4: Additional setpoint (PCTRL1-NADD)<br>POW5: Actual process controller value (PCTRL1-ACT)<br>POW6: Process controller setpoint (PCTRL1-SET1)<br>POW7: Reserved (FIF-RESERVED)<br>POW8: Torque setpoint or torque limit (MCTRL1-MSET)                                   | PROFIBUS communication manual                  |

| Step | Description   | Detailed information          |
|------|---|-------------------------------|
|      | POW9: PWM voltage (MCTRL1-VOLT-ADD)<br>POW10: PWM angle (MCTRL1-PHI-ADD)  |                               |
| 9.   | Assign process data output words of the standard device to the process data input words (PIW) of the master via C1510.<br><b>Lenze setting:</b><br>PIW1: DRIVECOM status word (DRIVECOM STAT)<br>PIW2: Output frequency with slip (MCTRL1-NOUT+SLIP)<br>PIW3: Output frequency without slip (MCTRL1-NOUT)<br>PIW4: Apparent motor current (MCTRL1-IMOT)<br>PIW5: Actual process controller value (PCTRL1-ACT)<br>PIW6: Process controller setpoint (PCTRL1-SET1)<br>PIW7: Process controller output (PCTRL1-OUT)<br>PIW8: Controller load (MCTRL1-MOUT)<br>PIW9: DC-bus voltage (MCTRL1-DCVOLT)<br>PIW10: Ramp function generator input (NSET1-RFG1-IN) | PROFIBUS communication manual |
| 10.  | Enable process output data via C1512 = 65535.<br><ul style="list-style-type: none"> <li>● Only required if C1511 has been changed.</li> <li>● Deactivate process data words that are not used by setting the respective subcode of code C1511 to 0.</li> <li>● The value in C1512 is volatile, and all process data are enabled after every switch-on.</li> </ul>   |                               |
| 11.  | Enable standard device via terminal 28 (CINH).<br><ul style="list-style-type: none"> <li>● Set terminal 28 to HIGH level.</li> </ul>  |                               |
| 12.  | Enter the setpoint.<br><ul style="list-style-type: none"> <li>● The master transmits the setpoint via the process data output word selected.</li> </ul>   |                               |
| 13.  | Change to the READY TO START status:<br><ul style="list-style-type: none"> <li>● The master transmits the DRIVECOM control word: 0000 0000 0111 1110<sub>bin</sub> (007E<sub>hex</sub>).</li> </ul>   | PROFIBUS communication manual |
| 14.  | The standard device is in the READY TO START status.<br><ul style="list-style-type: none"> <li>● The master receives the DRIVECOM status word: xxxx xxxx x01x 0001<sub>bin</sub></li> </ul>   |                               |
| 15.  | Change to the OPERATION ENABLED status.<br><ul style="list-style-type: none"> <li>● The master transmits DRIVECOM control word: 0000 0000 0111 1111<sub>bin</sub> (007F<sub>hex</sub>).</li> </ul>  |                               |
| 16.  | Now the drive starts up.  |                               |

**Configuring the host system (master)**

The host must be configured before communication with the communication module is possible.

**Master settings**

For configuring the PROFIBUS, the device data base file (GSE file) of the communication module has to be imported into the configuring software of the master.

**Tip!**

The GSE file can be downloaded from [www.Lenze.com](http://www.Lenze.com).

### Device data base file

The following configurations are saved in the device data base file LENZ00DA.GSE:

| Modules in LENZ00DA.GSE           | Parameter data<br>without/with consistency |      | Process data<br>without/with consistency |         | Assigned<br>I/O memory |
|-----------------------------------|--|------|--|---------|------------------------|
|                                   | Without                                    | With | Without                                  | With    |                        |
| PAR (Cons.) + PZD (n Words)       |  | •    | n words                                  |         | 4 + n words            |
| PAR (Cons.) + PZD (n Words Cons.) |  | •    |  | n words | 4 + n words            |
| PAR + PZD (n Words)               | •  |      | n words                                  |         | 4 + n words            |
| PZD (n Words)                     | Without parameter data channel             |      | n words                                  |         | n words                |
| PZD (n Words Cons.)               | Without parameter data channel             |      |  | n words | n words                |

n = 1 ... 10



#### Note!

##### Device control via FIF status/control word

Device control is only possible if the DRIVECOM status machine (Lenze setting) is switched off.

- ▶ Set C1510 /1 (PIW1) to the value "1":  
FIF status word 1 (FIF-STAT1).
- ▶ Set C1511 /1 (POW1) to the value "1":  
FIF control word 1 (FIF-CTRL1).
- ▶ Set C1512 to "65535" to reenable process output words.

For Lenze codes see (📖 69)



#### Tip!

##### Use overall consistency

- ▶ We recommend to use exclusively configurations with consistency for the parameter data channel to avoid data conflicts between PROFIBUS-DP master and host CPU.
- ▶ Please note that the processing of consistent data varies between hosts. This must be considered in the PROFIBUS-DP application program.
- ▶ Detailed description of consistency: (📖 87)

**6.3.1 Adapting device controls**

- ▶ Lenze device control
  - Set **C1511/1** (POW1) = 1 ⇒ FIF control word 1 (FIF-CTRL1)
  - Set **C1510/1** (PIW1) = 1 ⇒ FIF status word 1 (FIF-STAT1)
- ▶ Device control via DRIVECOM
  - Set **C1511/1** (POW1) = 17 ⇒ DRIVECOM control word (DRIVECOM-CTRL)
  - Set **C1510/1** (PIW1) = 18 ⇒ DRIVECOM status word (DRIVECOM-STAT)

For detailed information about the configuration of process data, see chapter "Process data transfer",  43)

**Tip!****Use overall consistency**

- ▶ Please observe that the processing of consistent data varies between hosts. This must be taken into account in the PROFIBUS application program.
- ▶ A detailed description of consistency can be found in the appendix ( 86)

### 6.3.2 Defining the user data length

The user data length is defined during the initialisation phase of the PROFIBUS. It is possible to configure up to 10 process data words (see chapter "Process data transfer", 43).

Optionally you can activate a parameter data channel. If the parameter data channel is active, it additionally occupies 4 words of the process input and process output data.

- ▶ PIW: process data input word (process data from standard device to master)
- ▶ POW: process data output word (process data from master to standard device)

The user data lengths for process input data and process output data are identical. The selection takes place via identification bytes in the configuration software for the PROFIBUS system.

| Parameter data channel |   | Process data channel  |
|------------------------|---|---|
| Without / with         | Identification / user data length   | Identification / user data length   |
| Without                | -   | <ul style="list-style-type: none"> <li>● Identification                             <ul style="list-style-type: none"> <li>– without consistency: 70<sub>hex</sub> ... 79<sub>hex</sub> (112 ... 121)</li> <li>– with consistency: F0<sub>hex</sub> ... F9<sub>hex</sub> (240 ... 249)</li> </ul> </li> <li>● User data length: 1 ... 10 words (POW1/PIW1 ... POW10/PIW10)</li> </ul> |
| With                   | <ul style="list-style-type: none"> <li>● Identification: F3<sub>hex</sub> (243)</li> <li>● User data length: 4 words (word 1 ... word 4)</li> </ul> | <ul style="list-style-type: none"> <li>● Identification                             <ul style="list-style-type: none"> <li>– without consistency: 70<sub>hex</sub> ... 79<sub>hex</sub> (112 ... 121)</li> <li>– with consistency: F0<sub>hex</sub> ... F9<sub>hex</sub> (240 ... 249)</li> </ul> </li> <li>● User data length: 1 ... 10 words (POW1/PIW1 ... POW10/PIW10)</li> </ul> |

#### General structure of the identification byte

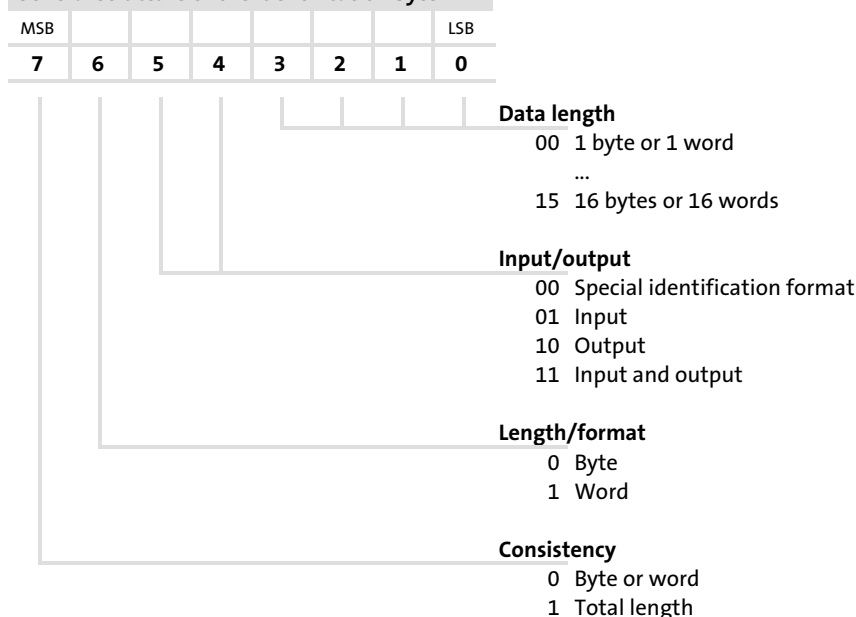

# 6

## Commissioning

### Activating the bus terminating resistor

#### 6.4

#### Activating the bus terminating resistor

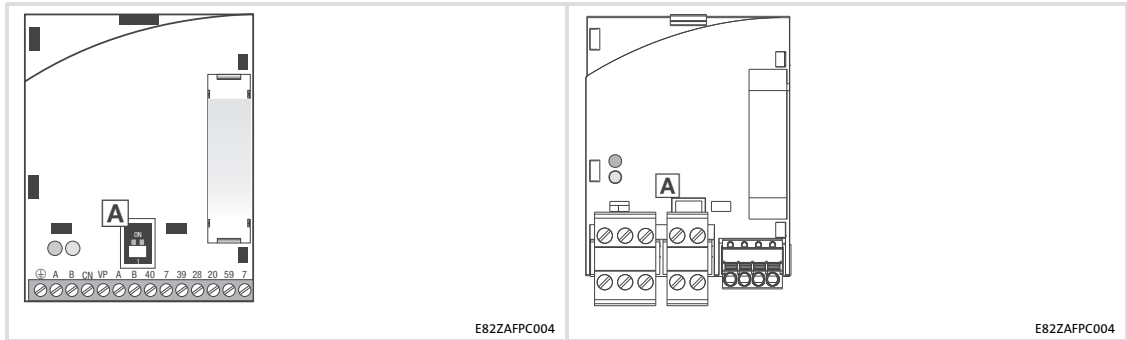

#### DIP switch **A**

DIP switch = ON Integrated active bus terminating resistor is switched on

DIP switch = OFF Integrated active bus terminating resistor is switched off



## **6.5 Setting the node address**

To address the basic devices, each device (station) is allocated a different node address in the PROFIBUS-DP network.

**Valid address range: 3 ... 126**

**(Lenze setting: 3)**

The node address can be selected freely via code C1509.

It can be set with

- ▶ the keypad,
- ▶ the PC / communication module, type 2102 LECOM, or
- ▶ the class 2 master.

**6.6 Connecting the mains voltage****Note!**

If the external voltage supply of the function module is used, the supply must be switched on as well.

- ▶ The standard device will be ready for operation approx. 1 s after switching on the supply voltage.
- ▶ Controller inhibit is active.
- ▶ The green LED at the front of the function module is lit (only visible in the case of the 8200 vector frequency inverter).

**Protection against uncontrolled start-up****Note!****Establishing communication**

For establishing communication via an externally supplied function module, the standard device must be switched on as well.

- ▶ After communication has been established, the externally supplied module is independent of the power on/off state of the standard device.

**Protection against uncontrolled start-up**

After a fault (e.g. short-term mains failure), a restart of the drive is not always wanted and - in some cases - even not allowed.

The restart behaviour of the controller can be set in C0142:

- ▶ C0142 = 0 (Lenze setting)
  - The controller remains inhibited (even if the fault is no longer active).
  - The drive starts in a controlled mode by explicitly enabling the controller: LOW-HIGH edge at terminal 28 (CINH)
- ▶ C0142 = 1
  - An uncontrolled restart of the drive is possible.

## 7 Process data transfer

PROFIBUS transmits parameter data and process data between the host (master) and the controllers connected to the bus (slaves). Depending on their time-critical nature, the data are transmitted via different communication channels.

- ▶ Process data are transmitted via the process data channel.
- ▶ Process data serve to control the drive controller.
- ▶ The transmission of process data is time-critical.
- ▶ Process data are cyclically transferred between the host and the controllers (continuous exchange of current input and output data).
- ▶ The host can directly access the process data. In the PLC, for instance, the data are directly assigned to the I/O area.
- ▶ With the function module a maximum of 10 process data words (16 bits/word) can be exchanged in each direction.
- ▶ Process data are not stored in the controller.
- ▶ Process data are, for instance, setpoints, actual values, control words and status words.



### Note!

Observe the direction of the information flow!

- ▶ Process input data (Rx data):
  - Process data from controller (slave) to host (master)
- ▶ Process output data (Tx data):
  - Process data from host (master) to controller (slave)

## 7.1 Lenze device control

Codes **C1510** (process input data) and **C1511** (process output data) can be used to freely assign up to 10 process data words of the PROFIBUS to the process data words of the controller.

**Note!**

- ▶ The PROFIBUS master *sends* process output data in up to 10 process data output words (POW) to the slave.
- ▶ The PROFIBUS master *receives* process input data in up to 10 process data input words (PIW) from the slave.

## 7.1.1 Process output data configuration

The assignment of up to 10 process data output words (POW) of the master to bit control commands, actual values or setpoints of the controller can be freely configured via code **C1511**.



**Note!**

- ▶ The assignment of control words of different device controls is not permitted.
  - ▶ If **C1511** is changed, the process output data are automatically inhibited to ensure data consistency.
  - ▶ Via **C1512** you can re-enable individual or all POWs.
- ▶ To activate the DRIVECOM device control, assign the DRIVECOM control word to a POW (**C1511/x = 17**).
    - The DRIVECOM control word is mapped to the FIF control word 1.
    - The controller operates in compliance with the DRIVECOM state machine. (📖 51).
  - ▶ You can set up an extended Lenze device control using the FIF control words (📖 47).

**C1511:**  
**Configuration of process output data**

| Code  | Subcode     | Index                                     | Possible settings |                 | Data type |
|-------|-------------|---|-------------------|-----------------|-----------|
|       |             |   | Lenze             | Selection       |           |
| C1511 |             | 23064 <sub>d</sub> =<br>5A18 <sub>h</sub> |                   |                 | FIX32     |
|       | 1 (POW1)    |   | 17                | see table below |           |
|       | 2 (POW2)    |   | 3                 |                 |           |
|       | 3 (POW3)    |   | 4                 |                 |           |
|       | 4 (POW 4)   |   | 5                 |                 |           |
|       | 5 (POW 5)   |   | 6                 |                 |           |
|       | 6 (POW 6)   |   | 7                 |                 |           |
|       | 7 (POW 7)   |   | 8                 |                 |           |
|       | 8 (POW 8)   |   | 9                 |                 |           |
|       | 9 (POW 9)   |   | 10                |                 |           |
|       | 10 (POW 10) |   | 11                |                 |           |

The process data output words (POW) of the master can be freely assigned to bit control commands or setpoints of the controller via C1511.

| Selection |  | Scaling  |
|-----------|--|--|
| 1         | FIF control word 1 (FIF-CTRL1)                   | 16 bits  |
| 2         | FIF control word 2 (FIF-CTRL2)                   | 16 bits  |
| 3         | Setpoint 1 (NSET1-N1)                            | $\pm 24000 \equiv \pm 480$ Hz  |
| 4         | Setpoint 2 (NSET1-N2)                            | $\pm 24000 \equiv \pm 480$ Hz  |
| 5         | Additional setpoint (PCTRL1-NADD)                | $\pm 24000 \equiv \pm 480$ Hz  |
| 6         | Actual process controller value (PCTRL1-ACT)     | $\pm 24000 \equiv \pm 480$ Hz  |
| 7         | Process controller setpoint (PCTRL1-SET1)        | $\pm 24000 \equiv \pm 480$ Hz  |
| 8         | Reserved   |  |
| 9         | Torque setpoint/torque limit value (MCTRL1-MSET) | $2^{14} \equiv 100$ % rated motor torque   |
| 10        | PWM voltage (MCTRL1-VOLT-ADD)                    |  For special applications only. |
| 11        | PWM angle (MCTRL1-PHI-ADD)                       |  System manual for 8200 vector  |
| 12        | Reserved   |  |
| 13        | FIF-IN.W1  | 16 bits or 0 ... 65535   |
| 14        | FIF-IN.W2  | 16 bits or 0 ... 65535   |
| 15        | FIF-IN.W3  | 0 ... 65535  |
| 16        | FIF-IN.W4  | 0 ... 65535  |
| 17        | DRIVECOM control word (DRIVECOM-CTRL)            | 16 bits  |

# Process data transfer

## Lenze device control

### Process output data configuration

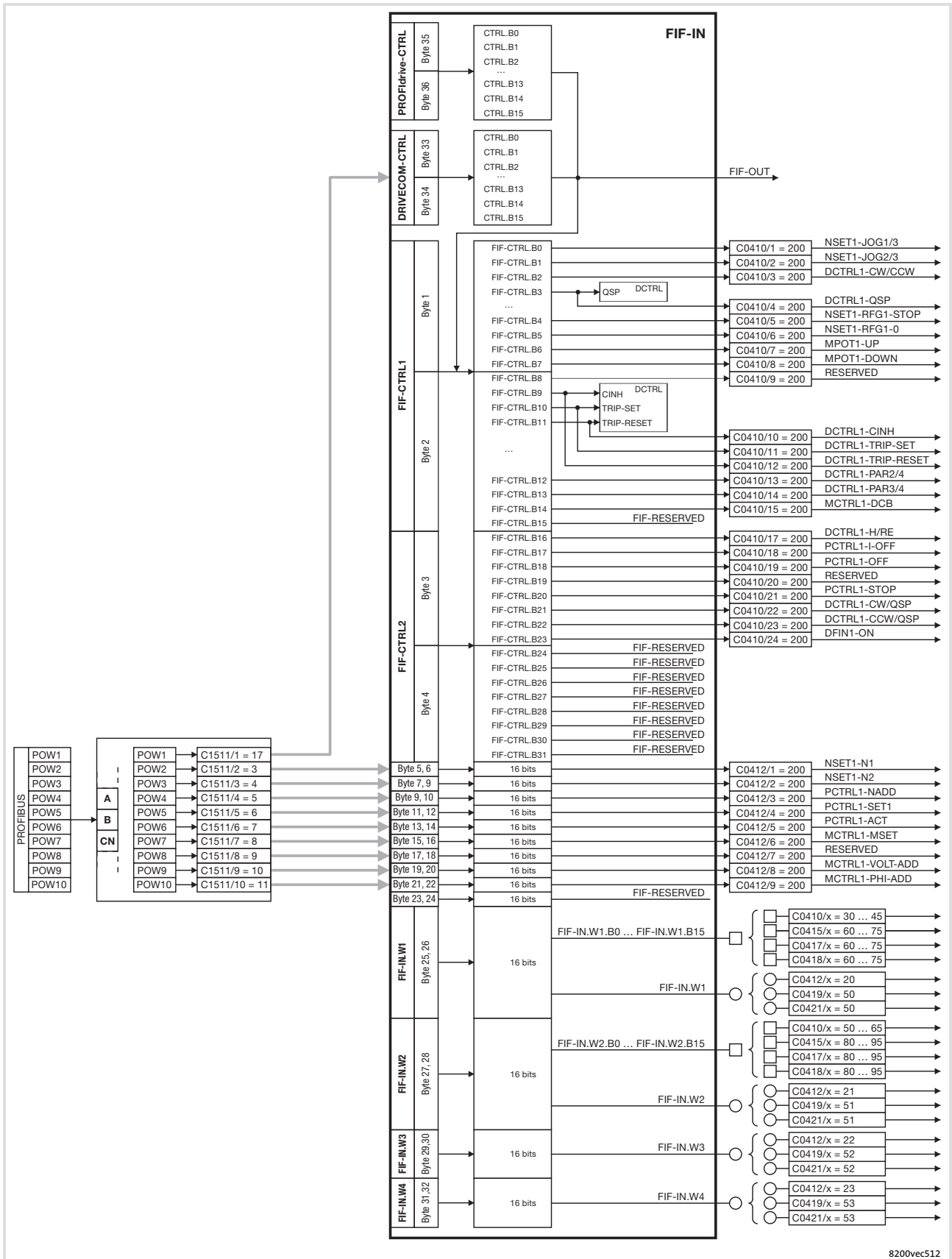

Fig. 7-1 Free configuration of the 10 PROFIBUS process output words

8200vec512

| FIF control word 1 (FIF-CTRL1) |   |  | FIF control word 2 (FIF-CTRL2) |  |            |  |
|--------------------------------|---|--|--------------------------------|--|------------|--|
| Bit                            | Assignment  |  | Bit                            | Assignment   |            |  |
| <b>0 / 1</b>                   | <b>JOG values</b> (NSET1-JOG2/3   NSET1-JOG1/3)                 |  | <b>0</b>                       | <b>Manual/remote changeover</b> (DCTRL1-H/Re)                      |            |  |
|                                | Bit   | 1   0                                    |                                | 0  | Not active |  |
|                                |   | 0   0                                    | 1                              | Active   |            |  |
|                                |   | 0   1                                    | <b>1</b>                       | <b>Switch off I-component of process controller</b> (PCTRL1-I-OFF) |            |  |
|                                |   | 1   0                                    |                                | 0  | Not active |  |
|                                | 1   1   | 1  | Active                         |  |            |  |
| <b>2</b>                       | <b>Current direction of rotation</b> (DCTRL1-CW/CCW)            |  | <b>2</b>                       | <b>Switch off process controller</b> (PCTRL1-OFF)                  |            |  |
|                                | 0   | Not inverted                             |                                | 0  | Not active |  |
|                                | 1   | Inverted                                 |                                | 1  | Active     |  |
| <b>3</b>                       | <b>Quick stop (QSP)</b> (FIF-CTRL1-QSP)                         |  | <b>3</b>                       | Reserved   |            |  |
|                                | 0   | Not active                               |                                | <b>Do not write to this bit!</b>                                   |            |  |
|                                | 1   | Active (deceleration via QSP ramp C0105) |                                |  |            |  |
| <b>4</b>                       | <b>Stop ramp function generator</b> (NSET1-RFG1-STOP)           |  | <b>4</b>                       | <b>Stop process controller</b> (PCTRL1-STOP)                       |            |  |
|                                | 0   | Not active                               |                                | 0  | Not active |  |
|                                | 1   | Active                                   |                                | 1  | Active     |  |
| <b>5</b>                       | <b>Ramp function generator input = 0</b> (NSET1-RFG1-0)         |  | <b>5</b>                       | <b>CW rotation/quick stop (QSP)</b> (DCTRL1-CW/QSP)                |            |  |
|                                | 0   | Not active                               |                                | 0  | Not active |  |
|                                | 1   | Active (deceleration via C0013)          |                                | 1  | Active     |  |
| <b>6</b>                       | <b>UP function of motor potentiometer</b> (MPOT1-UP)            |  | <b>6</b>                       | <b>CCW rotation/quick stop (QSP)</b> (DCTRL1-CCW/QSP)              |            |  |
|                                | 0   | Not active                               |                                | 0  | Not active |  |
|                                | 1   | Active                                   |                                | 1  | Active     |  |
| <b>7</b>                       | <b>DOWN function of motor potentiometer</b> (MPOT1-DOWN)        |  | <b>7</b>                       | <b>X3/E1 is digital frequency input</b> (DFIN1-ON)                 |            |  |
|                                | 0   | Not active                               |                                | 0  | Not active |  |
|                                | 1   | Active                                   |                                | 1  | Active     |  |
| <b>8</b>                       | Reserved  |  | <b>8</b>                       | Reserved   |            |  |
| <b>9</b>                       | <b>Controller inhibit</b> (FIF-CTRL1-CINH)                      |  | <b>9</b>                       | Reserved   |            |  |
|                                | 0   | Controller enabled                       |                                |  |            |  |
|                                | 1   | Controller inhibited                     |                                |  |            |  |
| <b>10</b>                      | <b>External fault</b> (FIF-CTRL1-TRIP-SET)                      |  | <b>10</b>                      | Reserved   |            |  |
| <b>11</b>                      | <b>Reset fault</b> (FIF-CTRL1-TRIP-RESET)                       |  | <b>11</b>                      | Reserved   |            |  |
|                                | 0 ⇒ 1   | Bit change resets TRIP                   |                                |  |            |  |
| <b>12 / 13</b>                 | <b>Parameter set changeover</b> (DCTRL1-PAR3/4   DCTRL1-PAR2/4) |  | <b>12</b>                      | Reserved   |            |  |
|                                | Bit   | 13   12                                  |                                | <b>13</b>  | Reserved   |  |
|                                |   | 0   0                                    | PAR1                           |  |            |  |
|                                |   | 0   1                                    | PAR2                           |  |            |  |
|                                |   | 1   0                                    | PAR3                           |  |            |  |
|                                | 1   1   | PAR4                                     |                                |  |            |  |
| <b>14</b>                      | <b>DC injection brake</b> (MTCRL1-DCB)                          |  | <b>14</b>                      | Reserved   |            |  |
|                                | 0   | Not active                               |                                |  |            |  |
|                                | 1   | Active                                   |                                |  |            |  |
| <b>15</b>                      | Reserved  |  | <b>15</b>                      | Reserved   |            |  |

Tab. 7-1 Parameter structure of FIF control word (FIF-CTRLx)



**Note!**

**Use of bit 5 and bit 6 in FIF control word 2**

Set codes **C0410/22** (DCTRL1-CW/QSP) and **C0410/23** (DCTRL1-CCW/QSP) to "200".

## 7.1.2 Process input data configuration

The assignment of the bit status information or the actual controller values to the up to 10 process data input words (PIW) of the master can be freely configured:

- To call DRIVECOM-conform status information, assign the DRIVECOM status word to a PIW (**C1511/x = 18**).

The FIF status word 1 is mapped to the DRIVECOM status word.

**C1510:**  
Configuration of process input data

| Code  | Subcode     | Index                                     | Possible settings |                 | Data type |
|-------|-------------|---|-------------------|-----------------|-----------|
|       |             |   | Lenze             | Selection       |           |
| C1510 |             | 23065 <sub>d</sub> =<br>5A19 <sub>h</sub> |                   |                 | FIX32     |
|       | 1 (PIW1)    |   | 18                | See table below |           |
|       | 2 (PIW2)    |   | 3                 |                 |           |
|       | 3 (PIW3)    |   | 4                 |                 |           |
|       | 4 (PIW 4)   |   | 5                 |                 |           |
|       | 5 (PIW 5)   |   | 6                 |                 |           |
|       | 6 (PIW 6)   |   | 7                 |                 |           |
|       | 7 (PIW 7)   |   | 8                 |                 |           |
|       | 8 (PIW 8)   |   | 9                 |                 |           |
|       | 9 (PIW 9)   |   | 10                |                 |           |
|       | 10 (PIW 10) |   | 11                |                 |           |

The bit status information or the actual values of the controller can be freely assigned to the max. 10 process data input words (PIW) of the master.

| Selection |   | Scaling  |
|-----------|---|--|
| 1         | FIF status word 1 (FIF-STAT1)                 | 16 bits  |
| 2         | FIF status word 2 (FIF-STAT2)                 | 16 bits  |
| 3         | Output frequency with slip (MCTRL1-NOUT+SLIP) | $\pm 24000 = \pm 480$ Hz   |
| 4         | Output frequency without slip (MCTRL1-NOUT)   | $\pm 24000 = \pm 480$ Hz   |
| 5         | Apparent motor current (MCTRL1-IMOT)          | $2^{14} = 100$ % rated device current  |
| 6         | Actual process controller value (PCTRL1-ACT)  | $\pm 24000 = \pm 480$ Hz   |
| 7         | Process controller setpoint (PCTRL1-SET)      | $\pm 24000 = \pm 480$ Hz   |
| 8         | Process controller output (PCTRL1-OUT)        | $\pm 24000 = \pm 480$ Hz   |
| 9         | Controller load (MCTRL1-MOUT)                 | $\pm 2^{14} = \pm 100$ % rated motor torque  |
| 10        | DC-bus voltage (MCTRL1-DCVOLT)                | 16383 $\equiv$ 565 V DC for 400 V mains<br>16383 $\equiv$ 325 V DC for 230 V mains |
| 11        | Ramp function generator input (NSET1-RFG1-IN) | $\pm 24000 = \pm 480$ Hz   |
| 12        | Ramp function generator output (NSET1-NOUT)   | $\pm 24000 = \pm 480$ Hz   |
| 13        | FIF-OUT.W1                                    | 16 bits or 0 ... 65535   |
| 14        | FIF-OUT.W2                                    | 16 bits or 0 ... 65535   |
| 15        | FIF-OUT.W3                                    | 0...65535  |
| 16        | FIF-OUT.W4                                    | 0...65535  |
| 17        | DRIVECOM control word (DRIVECOM-CTRL)         | 16 bits  |
| 18        | DRIVECOM status word (DRIVECOM-STAT)          | 16 bits  |



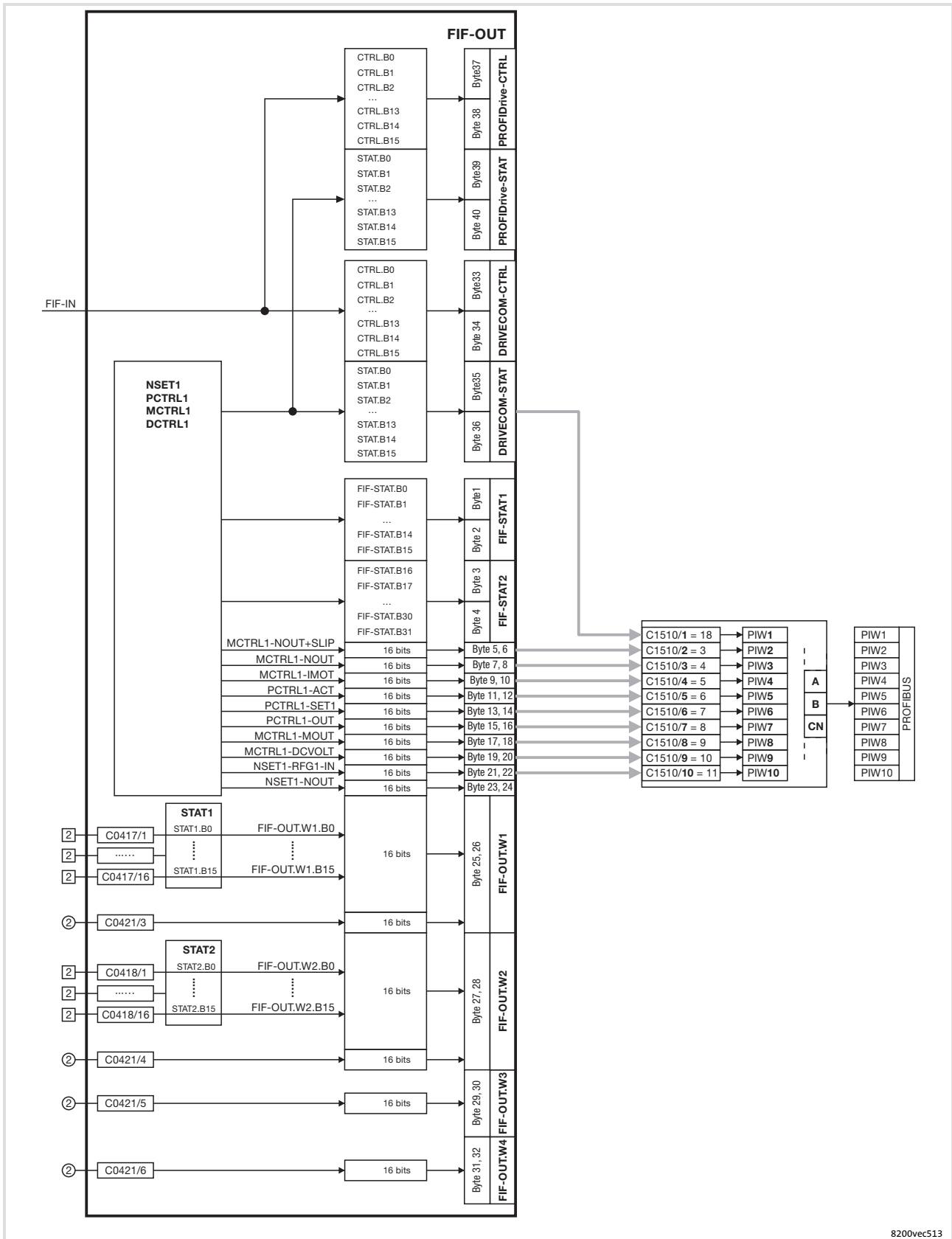

Fig. 7-2 Free configuration of the 10 PROFIBUS process input words

# 7 Process data transfer

## Lenze device control

### Process input data configuration

| FIF status word 1 (FIF-STAT1) |  |                                   |    | FIF status word 2 (FIF-STAT2) |   |                             |  |       |
|-------------------------------|--|-----------------------------------|----|-------------------------------|---|-----------------------------|--|-------|
| Bit                           | Assignment   |                                   |    | Bit                           | Assignment  |                             |  |       |
| 0                             | <b>Current parameter set bit 0</b> (DCTRL1-PAR-B0)   |                                   |    | 0                             | <b>Current parameter set bit 1</b> (DCTRL1-PAR-B1)  |                             |  |       |
|                               | 0  | Parameter set 1 or 3 active       |    |                               | 0   | Parameter set 1 or 2 active |  |       |
|                               | 1  | Parameter set 2 or 4 active       |    | 1                             | Parameter set 3 or 4 active   |                             |  |       |
| 1                             | <b>Pulse inhibit</b> (DCTRL1-IMP)  |                                   |    | 1                             | <b>TRIP, <math>Q_{min}</math> or pulse inhibit active</b> (DCTRL1-TRIP-QMIN-IMP)                |                             |  |       |
|                               | 0  | Power outputs enabled             |    |                               | 0   | False                       |  |       |
|                               | 1  | Power outputs inhibited           |    | 1                             | True  |                             |  |       |
| 2                             | <b><math>I_{max}</math> limit</b> (MCTRL1-IMAX)<br>(If C0014 = 5: Torque setpoint)         |                                   |    | 2                             | <b>PTC warning active</b> (DCTRL1-PTC-WARN)   |                             |  |       |
|                               | 0  | Not reached                       |    |                               | 0   | False                       |  |       |
|                               | 1  | Reached                           |    | 1                             | True  |                             |  |       |
| 3                             | <b>Output frequency = frequency setpoint</b><br>(DCTRL1-RFG1=NOUT)                         |                                   |    | 3                             | Reserved  |                             |  |       |
|                               | 0  | False                             |    |                               | <b>Do not write to this bit!</b>  |                             |  |       |
|                               | 1  | True                              |    |                               |   |                             |  |       |
| 4                             | <b>Ramp function generator input 1 = ramp function generator output 1</b> (NSET1-RFG1-I=0) |                                   |    | 4                             | <b>C0054 &lt; C0156 and <math>Q_{min}</math> threshold reached</b><br>(DCTRL1-(IMOT<ILIM)-QMIN) |                             |  |       |
|                               | 0  | False                             |    |                               | 0   | False                       |  |       |
|                               | 1  | True                              |    | 1                             | True  |                             |  |       |
| 5                             | <b><math>Q_{min}</math> threshold</b> (PCTRL1-QMIN)  |                                   |    | 5                             | <b>C0054 &lt; C0156 and NSET1-RFG1-I=0</b><br>(DCTRL1-(IMOT<ILIM)-RFG-I=0)                      |                             |  |       |
|                               | 0  | Not reached                       |    |                               | 0   | False                       |  |       |
|                               | 1  | Reached                           |    | 1                             | True  |                             |  |       |
| 6                             | <b>Output frequency = 0</b> (DCTRL1-NOUT=0)  |                                   |    | 6                             | <b>LP1 warning (fault in motor phase) active</b><br>(DCTRL1-LP1-WARN)                           |                             |  |       |
|                               | 0  | False                             |    |                               | 0   | False                       |  |       |
|                               | 1  | True                              |    | 1                             | True  |                             |  |       |
| 7                             | <b>Controller inhibit</b> (DCTRL1-CINH)  |                                   |    | 7                             | <b><math>f &lt; f_{min}</math></b> (NSET1-C0010 ... C0011)                                      |                             |  |       |
|                               | 0  | Controller enabled                |    |                               | 0   | False                       |  |       |
|                               | 1  | Controller inhibited              |    | 1                             | True  |                             |  |       |
| 11...8                        | <b>Device status</b> (DCTRL1-STAT*1 ... STAT*8)  |                                   |    | 8                             | <b>TRIP active</b> (DCTRL1-TRIP)  |                             |  |       |
|                               | Bit  | 11                                | 10 |                               | 9   | 8                           | 0  | False |
|                               |  | 0                                 | 0  | 0                             | 0   | 0                           | True   |       |
|                               |  | 0                                 | 0  | 1                             | 0   | 0                           | False  |       |
|                               |  | 0                                 | 0  | 1                             | 1   | 0                           | True   |       |
|                               |  | 0                                 | 1  | 0                             | 0   | 0                           | False  |       |
|                               |  | 0                                 | 1  | 0                             | 1   | 0                           | True   |       |
|                               |  | 0                                 | 1  | 1                             | 0   | 0                           | False  |       |
|                               |  | 0                                 | 1  | 1                             | 1   | 0                           | True   |       |
|                               |  | 1                                 | 0  | 0                             | 0   | 0                           | False  |       |
|                               |  | 1                                 | 1  | 1                             | 1   | 0                           | True   |       |
|                               |  |                                   |    |                               |   | 1                           | Communication with basic device not possible |       |
| 12                            | <b>Overtemperature warning</b> (DCTRL1-OH-WARN)  |                                   |    | 12                            | Reserved  |                             |  |       |
|                               | 0  | No warning                        |    |                               |   |                             |  |       |
|                               | 1  | $\vartheta_{max} - 10$ °C reached |    |                               |   |                             |  |       |
| 13                            | <b>DC-bus overvoltage</b> (DCTRL1-OV)  |                                   |    | 13                            | Reserved  |                             |  |       |
|                               | 0  | No overvoltage                    |    |                               |   |                             |  |       |
|                               | 1  | Overvoltage                       |    |                               |   |                             |  |       |
| 14                            | <b>Direction of rotation</b> (DCTRL1-CCW)  |                                   |    | 14                            | <b>C0054 &gt; C0156 and NSET1-RFG1-I=0</b><br>(DCTRL1-(IMOT>ILIM)-RFG-I=0)                      |                             |  |       |
|                               | 0  | CW rotation                       |    |                               | 0   | False                       |  |       |
|                               | 1  | CCW rotation                      |    | 1                             | True  |                             |  |       |
| 15                            | <b>Ready for operation</b> (DCTRL1-RDY)  |                                   |    | 15                            | Reserved  |                             |  |       |
|                               | 0  | Not ready for operation (fault)   |    |                               |   |                             |  |       |
|                               | 1  | Ready for operation (no fault)    |    |                               |   |                             |  |       |

Tab. 7-2 Parameter structure FIF status word (FIF-STATx)

7.2 DRIVECOM control

7.2.1 DRIVECOM state machine

The control information is provided by the function module via the control word.

- ▶ The controllers have standardised device states according to DRIVECOM Profile 20.
- ▶ Information on the current device status is stored in the DRIVECOM parameter "status word".
- ▶ Commands in the DRIVECOM parameter "control word" can change the device status. These commands are represented by arrows in the following diagram.

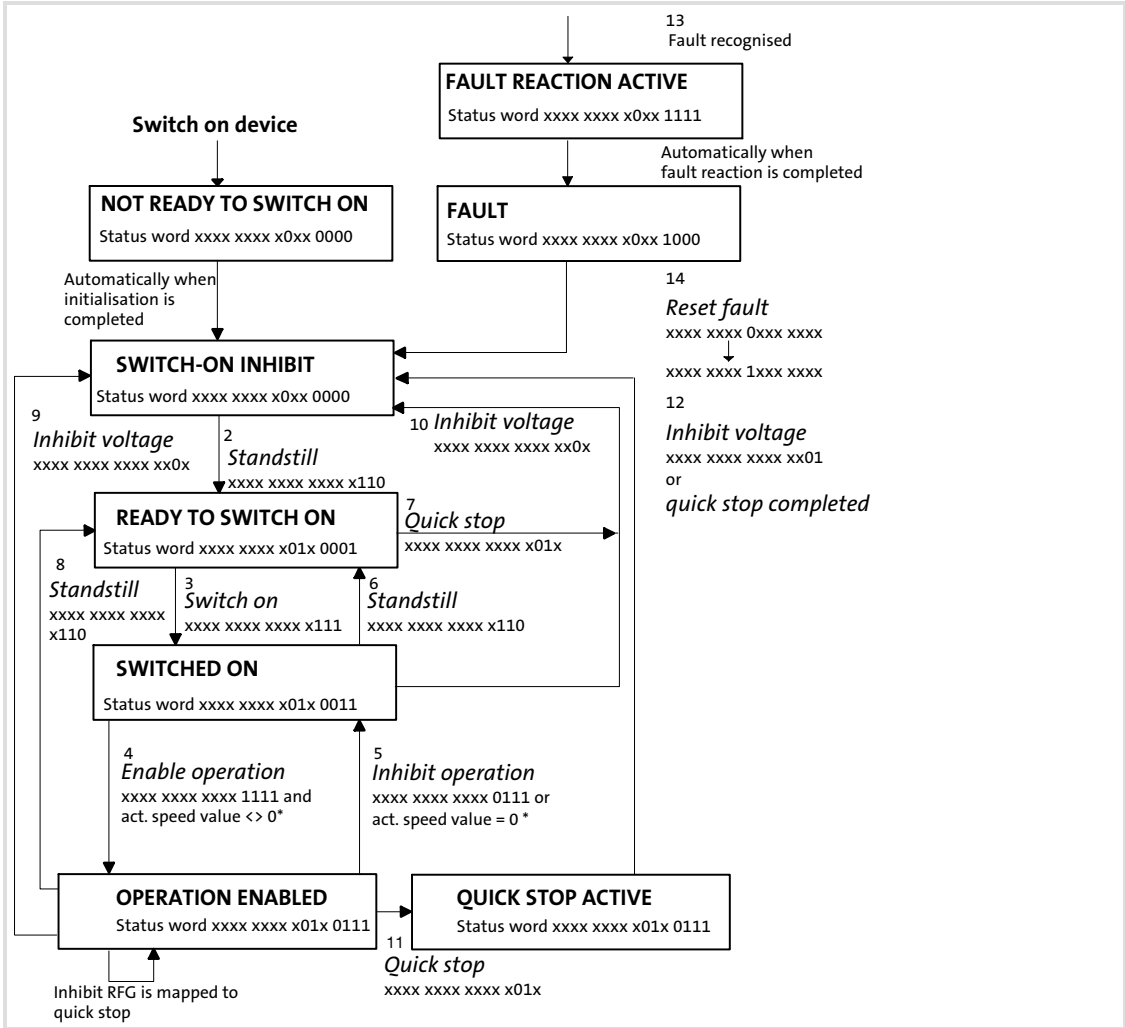

Fig. 7-3 Status diagram of DRIVECOM device control

\* only effective for 821X, 8200 vector when the automatic DC injection brake is active (C0106, C2106 <> 0)

## 7.2.2

## DRIVECOM control word

| Bit | Meaning  |
|-----|--|
| 0   | <b>"Switch on" command</b>   |
|     | 0 "Standstill" command active  |
|     | 1 "Switch on" command active   |
| 1   | <b>"Inhibit voltage" command</b>   |
|     | 0 "Inhibit voltage" command active   |
|     | 1 "Inhibit voltage" command not active   |
| 2   | <b>"Quick stop (QSP)" command</b>  |
|     | 0 "Quick stop (QSP)" command active  |
|     | 1 "Quick stop (QSP)" command not active  |
| 3   | <b>"Enable operation" command</b>  |
|     | 0 "Inhibit operation" command active   |
|     | 1 "Enable operation" command active  |
| 4   | <b>"Inhibit RFG" command</b>   |
|     | Inhibits the ramp function generator (NSET1-RFG1). The quick stop function (QSP) is activated; the device status of the drive does not change.<br>Mapping to FIF control word 1 (FIF-CTRL1), bit 3 negated (FIF-CTRL1-QSP)               |
|     | 0 "Inhibit RFG" active   |
|     | 1 "Inhibit RFG" not active   |
| 5   | <b>"RFG stop" command</b>  |
|     | Ramp function generator output (NSET1-RFG1) is "frozen"; the device status of the drive does not change.<br>Mapping to FIF control word 1 (FIF-CTRL1), bit 4 negated (NSET1-RFG1-STOP)   |
|     | 0 "RFG stop" active  |
|     | 1 "RFG stop" not active  |
| 6   | <b>"RFG zero" command</b>  |
|     | Sets ramp function generator input (NSET1-RFG1) to 0. ⇒ Controlled deceleration via the ramp set under C0013; the device status of the drive does not change.<br>Mapping to FIF control word 1 (FIF-CTRL1), bit 5 negated (NSET1-RFG1-0) |
|     | 0 "RFG zero" active  |
|     | 1 "RFG zero" not active  |
| 7   | <b>TRIP reset</b>  |
|     | Resets fault (TRIP)  |
|     | 0 ⇒ 1 Bit change resets TRIP   |
| 8   | DRIVECOM reserved  |
| 9   | DRIVECOM reserved  |
| 10  | DRIVECOM reserved  |
| 11  | Mapping to FIF control word 1 (FIF-CTRL1), bit 10 (FIF-CTRL1-TRIP-SET)   |
| 12  | Mapping to FIF control word 1 (FIF-CTRL1), bit 12 (DCTRL1-PAR2/4)  |
| 13  | Mapping to FIF control word 1 (FIF-CTRL1), bit 13 (DCTRL1-PAR-3/4)   |
| 14  | Mapping to FIF control word 1 (FIF-CTRL1), bit 14 (MCTRL1-DCB)   |
| 15  | Not used   |

Tab. 7-3 Parameter structure of "DRIVECOM control word" (DRIVECOM-CTRL)

### 7.2.3 DRIVECOM status word

| Bit       | Meaning  |
|-----------|--|
| <b>0</b>  | <b>Device status "Ready to switch on"</b><br>0 Status less than "Ready to switch on"<br>1 Status at least "Ready to switch on"   |
| <b>1</b>  | <b>Device status "Switched on"</b><br>0 Status less than "Switched on"<br>1 Status at least "Switched on"  |
| <b>2</b>  | <b>Device status "Operation enabled"</b><br>0 Status less than "Operation enabled"<br>1 Status "Operation enabled"   |
| <b>3</b>  | <b>Device status "Fault"</b><br>0 No fault (TRIP)<br>1 Fault (TRIP) active   |
| <b>4</b>  | <b>Status "Inhibit voltage" command</b><br>0 Command applied<br>1 Command not applied  |
| <b>5</b>  | <b>Status "Quick stop (QSP)" command</b><br>0 Command applied<br>1 Command not applied   |
| <b>6</b>  | <b>Device status "Switch-on inhibit"</b><br>0 Status "Switch-on inhibit" not active<br>1 Status "Switch-on inhibit" active   |
| <b>7</b>  | <b>Collective warning</b><br>0 No warning<br>1 Warning (overtemperature) active  |
| <b>8</b>  | <b>Collective message</b><br>Automatic setting and resetting of pulse inhibit (IMP) in the device status "Operation enabled".<br>Possible causes: Undervoltage, overvoltage or overcurrent<br>0 No message<br>1 Message IMP active |
| <b>9</b>  | Bus access right<br>1 Always   |
| <b>10</b> | <b>Status speed/frequency deviation</b><br>0 $RFG_{on} < > RFG_{off}$<br>1 $RFG_{on} = RFG_{off}$  |
| <b>11</b> | <b>Status DRIVECOM speed limitation</b><br>0 Always  |
| <b>12</b> | Mapping of FIF status word 1 (FIF-STAT1), bit 0 (DCTRL1-PAR-B0)  |
| <b>13</b> | Mapping of FIF status word 2 (FIFSTAT2), bit 0 (DCTRL1-PAR-B1)   |
| <b>14</b> | Mapping of FIF status word 1 (FIFSTAT1), bit 2 (MCTRL1-IMAX)   |
| <b>15</b> | Mapping of FIF status word 1 (FIF-STAT1), bit 5 (PCTRL1-QMIN)  |

#### 7.2.4 Bit control commands

| Bit control commands |  | The bit control commands of the control word depend on other bit settings. The command is executed only for the following bit patterns: |   |   |   |   |   |   |   |                   |
|----------------------|--|---|---|---|---|---|---|---|---|-------------------|
|                      |  | Bits of the control word  |   |   |   |   |   |   |   | Note              |
| Command              | Meaning  | 7   | 6 | 5 | 4 | 3 | 2 | 1 | 0 |                   |
| Standstill           | From different device states ⇒ "Ready to switch on"  | x   | x | x | x | x | 1 | 1 | 0 | 1: Bit set        |
| Switch on            | Transition ⇒ "Switched on"   | x   | x | x | x | x | 1 | 1 | 1 | 0: Bit not set    |
| Enable operation     | Transition ⇒ "Operation enabled"<br>The controller inhibit (CINH) is deactivated.                                    | x   | x | x | x | 1 | 1 | 1 | 1 |                   |
| Inhibit operation    | Transition ⇒ "Switched on"<br>The controller inhibit (CINH) is activated.  | x   | x | x | x | 0 | 1 | 1 | 1 |                   |
| Inhibit voltage      | Transition ⇒ "Switch-on inhibit"<br>The controller inhibit (CINH) is activated.                                      | x   | x | x | x | x | x | 0 | x | x: Any bit status |
| Quick stop (QSP)     | Transition ⇒ "Switch-on inhibit"<br>If the drive has been enabled ⇒ controlled deceleration via the quick stop ramp. | x   | x | x | x | x | 0 | 1 | x |                   |
| Reset fault          | Reset fault<br>If the fault has been removed, automatically ⇒ "Switch-on inhibit".                                   | 0<br>⇒1   | x | x | x | x | x | x | x |                   |

Reset fault  
RFG zero  
RFG stop  
Inhibit RFG  
Enable operation  
Quick stop (QSP)  
Inhibit voltage  
Switch on

### 7.2.5 Status bits

| Status bits             |  | The current device status is unambiguously coded in the bits 0 ... 6 of the status word: |   |   |   |   |   |   | Note             |
|-------------------------|--|--|---|---|---|---|---|---|------------------|
| Device status           | Meaning  | Bits of the status word  |   |   |   |   |   |   |                  |
|                         |  | 6  | 5 | 4 | 3 | 2 | 1 | 0 |                  |
| Not ready to switch on  | Controller is being initialised and is not yet ready to operate.<br>After initialisation automatically ⇒ "Ready to switch on"  | 0  | x | x | 0 | 0 | 0 | 0 | 1 Bit set        |
| Switch-on inhibit       | Controller inhibited (CINH).<br>Waiting for "Standstill" command   | 1  | x | x | 0 | 0 | 0 | 0 | 0 Bit not set    |
| Ready to switch on      | Controller inhibited (CINH).<br>Waiting for "Switch-on" command  | 0  | 1 | x | 0 | 0 | 0 | 1 |                  |
| Switched on             | Controller inhibited (CINH).<br>Waiting for "Operation enabled" command.   | 0  | 1 | x | 0 | 0 | 1 | 1 | x Any bit status |
| Operation enabled       | Controller enabled ( $\overline{\text{CINH}}$ ).<br>Pulse inhibit can be set automatically   | 0  | 1 | x | 0 | 1 | 1 | 1 |                  |
| Fault reaction active   | Fault (TRIP) recognised, a time-based, fault-dependent reaction is executed.<br>Then automatically ⇒ "Fault"   | 0  | x | x | 1 | 1 | 1 | 1 |                  |
| Fault                   | Controller is in the device status "Fault".  | 0  | x | x | 1 | 0 | 0 | 0 |                  |
| Quick stop (QSP) active | "Quick stop (QSP)" command has been sent in the device status "Operation enabled" ⇒ controlled deceleration via the quick stop ramp.<br>After deceleration automatically ⇒ "Switch-on inhibit" | 0  | 0 | x | 0 | 1 | 1 | 1 |                  |



### 8 Parameter data transfer

PROFIBUS transmits parameter data and process data between the host (master) and the drives connected to the bus (slaves). Depending on their time-critical nature, the data are transmitted via different communication channels.

- ▶ Parameter data are transmitted via the parameter data channel.
  - DRIVECOM parameter data channel
  - PROFIdrive parameter data channel (DP-V0 / DP-V1)
- ▶ The parameter data channel provides access to all Lenze codes.
- ▶ In general, the transfer of parameter data is not time-critical.
- ▶ Parameter data are, for instance, operating parameters, diagnostic information and motor data.



#### Note!

Cyclic writing to codes via PROFIBUS is only permissible if the automatic parameter set storage of the controller **C0003** is deactivated (value 0).



## 8.1 DRIVECOM parameter data channel

The DRIVECOM parameter data channel ...

- ▶ enables parameter setting and diagnostics of the controller.
- ▶ allows access to all Lenze parameters (codes).
- ▶ additionally occupies 4 words of the input and output data words in the master.
- ▶ has an identical structure for both directions of transmission.

### 8.1.1 Addressing of the parameter data

The parameter data is accessed via codes listed in the code table included in this documentation of the function module and the corresponding documentation of your controller.

### 8.1.2 Addressing of the Lenze parameters

In the case of the DRIVECOM parameter data channel the parameters of a device are not directly addressed via Lenze code numbers, but via indexes (byte 3, byte 4) and subindexes (byte 2).

The Lenze code numbers are converted into indexes via an offset ( $24575_{\text{dec}} / 5\text{FFF}_{\text{hex}}$ ):

| Addressing of Lenze codes   | Example for C0001 (operating mode)  |
|---|---|
| <ul style="list-style-type: none"> <li>• PROFIBUS index =<br/>24575 - Lenze code</li> </ul>   | <ul style="list-style-type: none"> <li>• PROFIBUS index =<br/>24575 - 1 = 24574</li> </ul>  |
| <ul style="list-style-type: none"> <li>• PROFIBUS-DP-Index<sub>hex</sub> =<br/>5FFF<sub>hex</sub> - Lenze code<sub>hex</sub></li> </ul> | <ul style="list-style-type: none"> <li>• PROFIBUS-DP-Index<sub>hex</sub> =<br/>5FFF<sub>hex</sub> - 1<sub>hex</sub> = 5FFE<sub>hex</sub></li> </ul> |

Lenze parameters are mainly represented in the fixed point format (data type integer32 with four decimal digits). For this reason, the value of the parameter/code must be multiplied by 10000 in order to obtain integer values.

The parameter value is entered in the user data (bytes 5 ... 8) of the telegram.

#### Example:

Set C0039 (JOG) = 150.4 Hz.

- ▶  $150.4 \times 10000 = 1504000$  (0016F300<sub>hex</sub>)
- ▶ The resulting parameter value is entered in the user data.

### 8.1.3 Telegram structure

The telegram of the DRIVECOM parameter data channel consists of a total of 8 bytes. The individual bytes are described in detail on the following pages.

| Byte 1  | Byte 2   | Byte 3             | Byte 4            | Byte 5              | Byte 6              | Byte 7              | Byte 8              |
|---------|----------|--------------------|-------------------|---------------------|---------------------|---------------------|---------------------|
| Service | Subindex | Index<br>High byte | Index<br>Low byte | Data 4 /<br>Error 4 | Data 3 /<br>Error 3 | Data 2 /<br>Error 2 | Data 1 /<br>Error 1 |

## Byte 1: Service, request and response control for the parameter data channel

| Byte 1  | Byte 2   | Byte 3             | Byte 4            | Byte 5              | Byte 6              | Byte 7              | Byte 8              |
|---------|----------|--------------------|-------------------|---------------------|---------------------|---------------------|---------------------|
| Service | Subindex | Index<br>High byte | Index<br>Low byte | Data 4 /<br>Error 4 | Data 3 /<br>Error 3 | Data 2 /<br>Error 2 | Data 1 /<br>Error 1 |

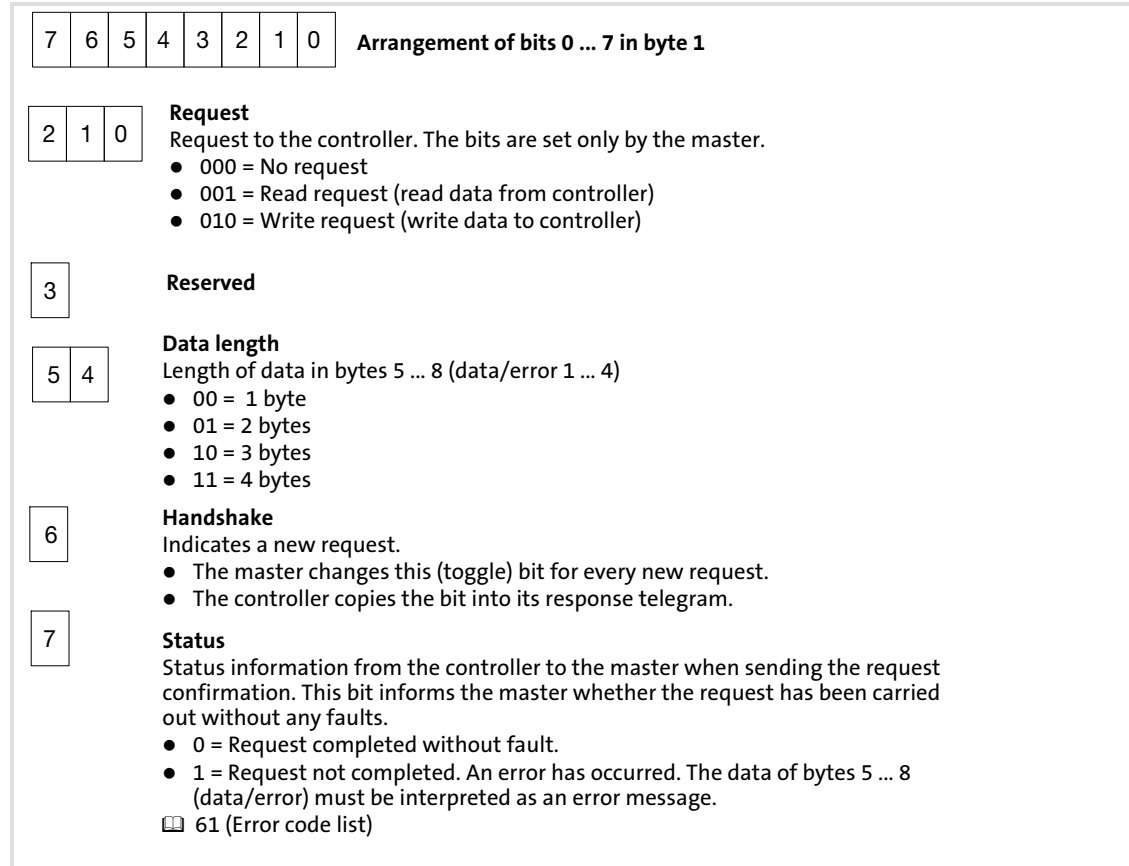

## Examples of byte 1:

## ► Read request

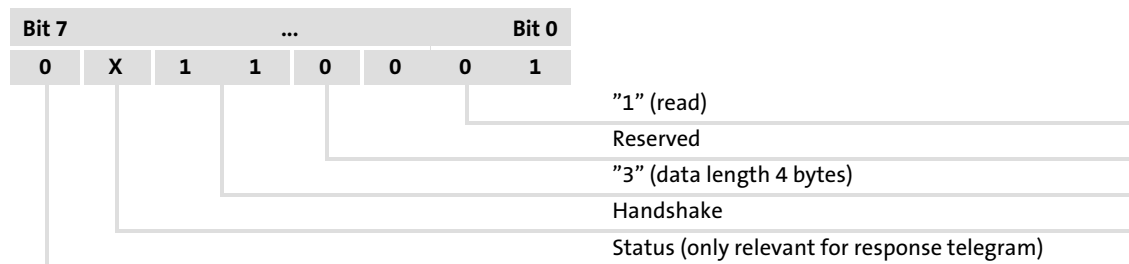

## ► Write request

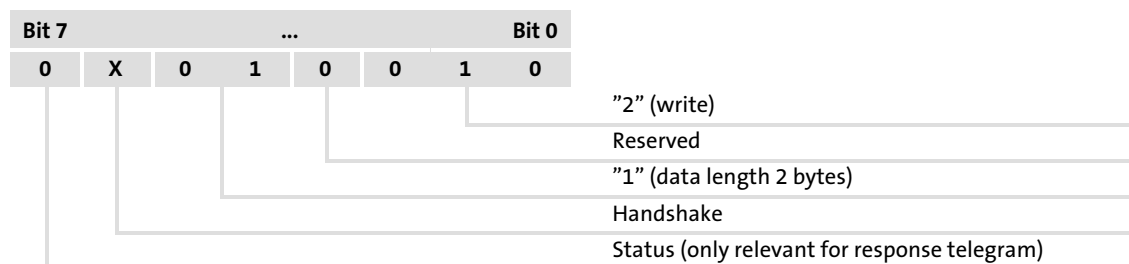

**Byte 2: Subindex**

| Byte 1  | Byte 2          | Byte 3             | Byte 4            | Byte 5              | Byte 6              | Byte 7              | Byte 8              |
|---------|-----------------|--------------------|-------------------|---------------------|---------------------|---------------------|---------------------|
| Service | <b>Subindex</b> | Index<br>High byte | Index<br>Low byte | Data 4 /<br>Error 4 | Data 3 /<br>Error 3 | Data 2 /<br>Error 2 | Data 1 /<br>Error 1 |

Additional addressing via the subindex is required for those codes that have a subcode (see code table).

**Example:**

Code C0039 / subcode 3 addresses "NSET JOG" (50 % = Lenze setting)

**Byte 3 / 4: index**

| Byte 1  | Byte 2   | Byte 3                     | Byte 4                    | Byte 5              | Byte 6              | Byte 7              | Byte 8              |
|---------|----------|----------------------------|---------------------------|---------------------|---------------------|---------------------|---------------------|
| Service | Subindex | <b>Index<br/>High byte</b> | <b>Index<br/>Low byte</b> | Data 4 /<br>Error 4 | Data 3 /<br>Error 3 | Data 2 /<br>Error 2 | Data 1 /<br>Error 1 |

The parameter or the Lenze code is selected with these two bytes according to the formula:

$$\text{Index} = 24575 - \text{Lenze code number}$$

**Example:**

The parameter C0012 (acceleration time) is to be addressed:

- ▶  $24575 - 12 = 24563 = 5FF3_{\text{hex}}$
- ▶ Entry in byte 3 (high byte):  $5F_{\text{hex}}$
- ▶ Entry in byte 4 (low byte):  $F3_{\text{hex}}$

## Parameter data transfer

DRIVECOM parameter data channel  
Telegram structure

### Bytes 5 ... 8: Parameter value (data) / error information (error)

| Byte 1  | Byte 2   | Byte 3             | Byte 4            | Byte 5              | Byte 6              | Byte 7              | Byte 8              |
|---------|----------|--------------------|-------------------|---------------------|---------------------|---------------------|---------------------|
| Service | Subindex | Index<br>High byte | Index<br>Low byte | Data 4 /<br>Error 4 | Data 3 /<br>Error 3 | Data 2 /<br>Error 2 | Data 1 /<br>Error 1 |

The status of the (status) bit 7 in byte 1 (job) determines the meaning of this data field:

| Meaning of the bytes 5 ... 8 if ... |  |
|-------------------------------------|--|
| Bit 7 = 0                           | Bit 7 = 1  |
| Parameter value (data 1 ... 4)      | Error information (error 1 ... 4) for an invalid access.<br> 61 (Error code list) |

### Parameter value (data)

Depending on the data format, the length of the parameter value is between 1 to 4 bytes. Data are saved in the Motorola format, i. e. first the high byte or high word, then the low byte or low word.

| Byte 5      | Byte 6   | Byte 7    | Byte 8   |
|-------------|----------|-----------|----------|
| High byte   | Low byte | High byte | Low byte |
| High word   |          | Low word  |          |
| Double word |          |           |          |

Assignment of bytes 5 .. 8 with parameter values of different lengths

| Byte 5                        | Byte 6 | Byte 7 | Byte 8 |
|-------------------------------|--------|--------|--------|
| Parameter value<br>(Length 1) | 00     | 00     | 00     |
| Parameter value (length 2)    |        | 00     | 00     |
| Parameter value (length 4)    |        |        |        |



#### Note!

Strings or data blocks cannot be transmitted.

**8.1.4 Error codes (DRIVECOM)**

| Data 1 | Data 2 | Data 3 | Data 4                              | Meaning  |
|--------|--------|--------|-------------------------------------|--|
| 0x06   | 0x03   | 0x00   | 0x00                                | No right to access   |
| 0x06   | 0x05   |        | 0x10                                | Impermissible job parameter  |
| 0x06   | 0x05   |        | 0x11                                | Invalid subindex   |
| 0x06   | 0x05   |        | 0x12                                | Data length too large  |
| 0x06   | 0x05   |        | 0x13                                | Data length too small  |
| 0x06   | 0x06   |        | 0x00                                | Object is no parameter   |
| 0x06   | 0x07   |        | 0x00                                | Object does not exist  |
| 0x06   | 0x08   |        | 0x00                                | Data types do not correspond   |
| 0x08   | 0x00   |        | 0x00                                | Job cannot be executed   |
| 0x08   | 0x00   |        | 0x20                                | Job cannot be executed at the moment                                       |
| 0x08   | 0x00   |        | 0x21                                | Not executable because of local control                                    |
| 0x08   | 0x00   |        | 0x22                                | Not executable because of device status                                    |
| 0x08   | 0x00   |        | 0x30                                | Out of value range/parameter can only be changed with inhibited controller |
| 0x08   | 0x00   |        | 0x31                                | Parameter value too large  |
| 0x08   | 0x00   |        | 0x32                                | Parameter value too small  |
| 0x08   | 0x00   |        | 0x33                                | Subparameter out of value range  |
| 0x08   | 0x00   |        | 0x34                                | Subparameter value too large   |
| 0x08   | 0x00   |        | 0x35                                | Subparameter value too small   |
| 0x08   | 0x00   |        | 0x36                                | Maximum value smaller than minimum value                                   |
| 0x08   | 0x00   |        | 0x41                                | Communication object cannot be mapped on process data                      |
| 0x08   | 0x00   | 0x42   | Process data length exceeded        |  |
| 0x08   | 0x00   | 0x43   | General collision with other values |  |
| 0x08   | 0x00   | 0xFE   | 0x01                                | Invalid service (no read or write request)                                 |

## 8.1.5 Reading parameters

## General procedure

1. Define the user data range of the controller. (Where are the user data located in the host system?)  
Observe manufacturer-specific information.
2. Enter the address of the required parameter into the "Index" and "Subindex" fields (DP output data).
3. Request in the service byte = read request  
The status of the handshake bit in the service byte must be changed (DP output data).
4. Check whether the handshake bit in the service byte is the same for the DP input data and the DP output data.  
If the handshake bit is the same, the response has been received.  
It is useful to implement a time monitoring tool.
5. Check whether the status bit in the service byte is set.  
Status bit is not set: The "Data/Error" field contains the required parameter value.  
Status bit is set: The read request has not been executed correctly. The "Data/Error" field contains the error information.

## Example:

The heatsink temperature (43 °C) of the controller is to be read (C0061).

## ► Byte 1: Request

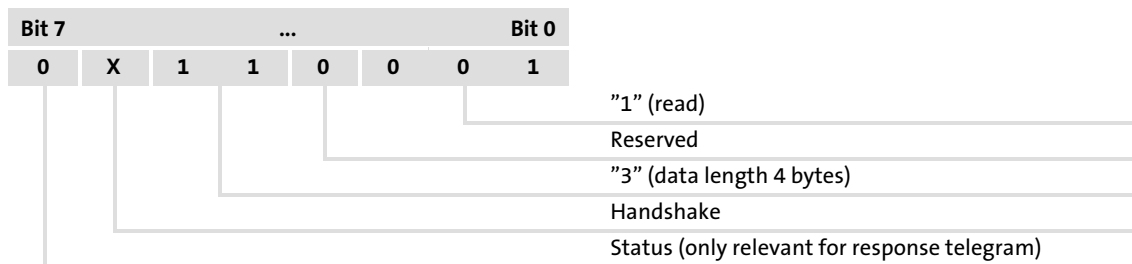

## ► Byte 2: Subindex

Subindex = 0, as there is no subindex under code C0061.

## ► Byte 3 / 4: Index

Index = 24575 - code number

Index = 24575 - 61 = 24514 = 5FC2<sub>hex</sub> (5F<sub>hex</sub> = high byte, C2<sub>hex</sub> = low byte)

## ► Bytes 5 ... 8: Data (contained in the response telegram)

Data 1 ... 4 = 43 °C x 10000 = 430000 (FIX32) = 00068FB0<sub>hex</sub>

**Result:**

- ▶ Request telegram from master to drive:

| Byte 1   | Byte 2   | Byte 3   | Byte 4   | Byte 5   | Byte 6   | Byte 7   | Byte 8   |
|--|--|--|--|--|--|--|--|
| Service  | Subindex   | Index<br>(High byte)                               | Index<br>(Low byte)                                | Data 4   | Data 3   | Data 2   | Data 1   |
| <b>01<sub>hex</sub></b><br>00000001 <sub>bin</sub> | <b>00<sub>hex</sub></b><br>00000000 <sub>bin</sub> | <b>5F<sub>hex</sub></b><br>01011111 <sub>bin</sub> | <b>C2<sub>hex</sub></b><br>11000010 <sub>bin</sub> | <b>00<sub>hex</sub></b><br>00000000 <sub>bin</sub> | <b>00<sub>hex</sub></b><br>00000000 <sub>bin</sub> | <b>00<sub>hex</sub></b><br>00000000 <sub>bin</sub> | <b>00<sub>hex</sub></b><br>00000000 <sub>bin</sub> |

Waiting for change of handshake bit in the response (bit 6 here: 0 → 1)

- ▶ Response telegram from drive to master (for error-free execution):

| Byte 1   | Byte 2   | Byte 3   | Byte 4   | Byte 5   | Byte 6   | Byte 7   | Byte 8   |
|--|--|--|--|--|--|--|--|
| Service  | Subindex   | Index<br>(High byte)                               | Index<br>(Low byte)                                | Data 4   | Data 3   | Data 2   | Data 1   |
| <b>30<sub>hex</sub></b><br>00110000 <sub>bin</sub> | <b>00<sub>hex</sub></b><br>00000000 <sub>bin</sub> | <b>5F<sub>hex</sub></b><br>01011111 <sub>bin</sub> | <b>C2<sub>hex</sub></b><br>11000010 <sub>bin</sub> | <b>00<sub>hex</sub></b><br>00000000 <sub>bin</sub> | <b>06<sub>hex</sub></b><br>00000110 <sub>bin</sub> | <b>8F<sub>hex</sub></b><br>10001111 <sub>bin</sub> | <b>B0<sub>hex</sub></b><br>10110000 <sub>bin</sub> |

## 8.1.6 Writing parameters

## General procedure

1. Define the user data range of the controller. (Where are the user data located in the host system?)  
Observe manufacturer-specific information.
2. Enter the address of the required parameter into the "Index" and "Subindex" fields (DP output data).
3. Enter the parameter value into the "Data/Error" field.
4. Request in the service byte = write request  
The status of the handshake bit in the service byte must be changed (DP output data).
5. Check whether the handshake bit in the service byte is the same for the DP input data and the DP output data.  
If the handshake bit is the same, the response has been received.  
It is useful to implement a time monitoring tool.
6. Check whether the status bit in the service byte is set.  
Status bit is not set: The write request has been executed correctly.  
Status bit is set: The write request has not been executed correctly. The "Data/Error" field contains the error information.

## Example:

The acceleration time (C0012) of the controller is to be set to 20 s.

## ► Byte 1: Request

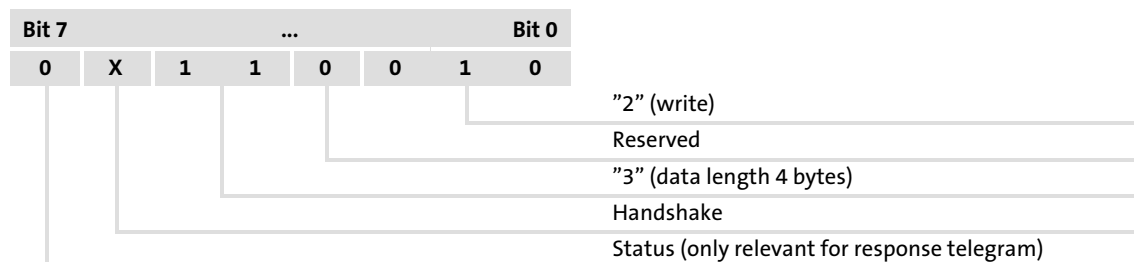

## ► Byte 2: Subindex

Subindex = 0, as there is no subindex under code C0012.

## ► Byte 3 / 4: Index

Index = 24575 - code number

Index = 24575 - 12 = 24563 = 5FF3<sub>hex</sub> (5F<sub>hex</sub> = high byte, F3<sub>hex</sub> = low byte)

## ► Bytes 5 ... 8: data

Data 1 ... 4 = 20 s x 10000 = 200000 (FIX32) = 00030D40<sub>hex</sub>



**Result:**

- ▶ Request telegram from master to drive:

| Byte 1  | Byte 2   | Byte 3   | Byte 4   | Byte 5   | Byte 6   | Byte 7   | Byte 8   |
|---|--|--|--|--|--|--|--|
| Service   | Subindex   | Index<br>(High byte)                               | Index<br>(Low byte)                                | Data 4   | Data 3   | Data 2   | Data 1   |
| <b>72<sub>hex</sub></b><br>01110010 <sub>bin</sub>      | <b>00<sub>hex</sub></b><br>00000000 <sub>bin</sub> | <b>5F<sub>hex</sub></b><br>01011111 <sub>bin</sub> | <b>F3<sub>hex</sub></b><br>11110011 <sub>bin</sub> | <b>00<sub>hex</sub></b><br>00000000 <sub>bin</sub> | <b>03<sub>hex</sub></b><br>00000011 <sub>bin</sub> | <b>0D<sub>hex</sub></b><br>00001101 <sub>bin</sub> | <b>40<sub>hex</sub></b><br>01000000 <sub>bin</sub> |
| Waiting for change of handshake bit (bit 6 here: 0 → 1) |  |  |  |  |  |  |  |

- ▶ Response telegram from drive to master (for error-free execution):

| Byte 1  | Byte 2   | Byte 3   | Byte 4   | Byte 5   | Byte 6   | Byte 7   | Byte 8   |
|---|--|--|--|--|--|--|--|
| Service   | Subindex   | Index<br>(High byte)                               | Index<br>(Low byte)                                | Data 4   | Data 3   | Data 2   | Data 1   |
| <b>40<sub>hex</sub></b><br>01000110 <sub>bin</sub>      | <b>00<sub>hex</sub></b><br>00000000 <sub>bin</sub> | <b>5F<sub>hex</sub></b><br>01011111 <sub>bin</sub> | <b>F3<sub>hex</sub></b><br>11110011 <sub>bin</sub> | <b>00<sub>hex</sub></b><br>00000000 <sub>bin</sub> | <b>00<sub>hex</sub></b><br>00000000 <sub>bin</sub> | <b>00<sub>hex</sub></b><br>00000000 <sub>bin</sub> | <b>00<sub>hex</sub></b><br>00000000 <sub>bin</sub> |
| Waiting for change of handshake bit (bit 6 here: 1 → 0) |  |  |  |  |  |  |  |

### Lenze parameter sets

The 8200 vector and 8200 motec controllers have 2/4 parameter sets, whose parameters can directly be addressed with the PROFIBUS.



#### Note!

- ▶ Parameter set 1 can be accessed via ...
  - DRIVECOM parameter data channel
  - PROFIdrive parameter data channel (DP-V0)
  - PROFIdrive parameter data channel (DP-V1)
- ▶ Parameter sets 2 ... 4 can be accessed via ...
  - DRIVECOM parameter data channel
  - PROFIdrive parameter data channel (DP-V1)

### Addressing of Lenze parameter sets

The parameter sets are addressed by means of a code offset:

- ▶ Offset 0 addresses parameter set 1 (C0000 ... C1999).
- ▶ Offset 2000 addresses parameter set 2 (C2000 ... C3999).
- ▶ Offset 4000 addresses parameter set 3 (C4000 ... C5999).
- ▶ Offset 6000 addresses parameter set 4 (C6000 ... C7999).

If a parameter is only available once (see documentation for 8200 vector), use the code offset 0.

#### Example for C0011 (maximum rotating-field frequency):

- ▶ C0011 in parameter set 1: Lenze code number = 11
- ▶ C0011 in parameter set 2: Lenze code number = 2011
- ▶ C0011 in parameter set 3: Lenze code number = 4011
- ▶ C0011 in parameter set 4: Lenze code number = 6011

### Parameter set transfer with keypad



#### Note!

**Always switch the mains after you have transferred the parameter sets with the keypad!**

Observe the options for parameter set transfer with keypad marked with "Keypad ⇨" under code **C0002**.

If an address is assigned via **C1509**, the address must be reassigned via the parameter data channel after a parameter set transfer. Afterwards mains switching is required. The address modified via keypad becomes effective immediately.

## 9 Diagnostics

### 9.1 LED status displays

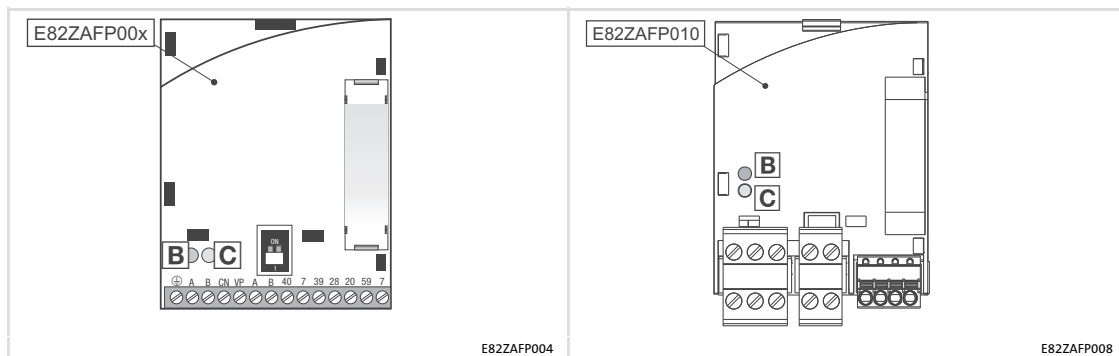

| LED   |                  |           |  |
|-------|------------------|-----------|--|
| Pos.  | Colour           | Condition | Description  |
| B     | yellow           | off       | No communication with the PROFIBUS master.   |
|       |                  | blinking  | Communication with the PROFIBUS master has been established via the function module.   |
| C     | green            | off       | <ul style="list-style-type: none"> <li>The function module is not supplied with voltage.</li> <li>The standard device and/or the external voltage supply is switched off.</li> </ul>   |
|       |                  | blinking  | The function module is supplied with voltage but is not connected to the standard device.<br>Causes: <ul style="list-style-type: none"> <li>The standard device is switched off.</li> <li>The standard device is in the initialisation phase.</li> <li>The standard device is not available</li> </ul> |
|       |                  | on        | The function module is supplied with voltage and is connected to the standard device.  |
| B + C | yellow/<br>green | blinking  | Internal function module error   |





















## 9.2

## Troubleshooting and fault elimination

| Fault  | Possible cause                                     | Remedy  |
|--|--|---|
| The PROFIBUS master indicates a bus error and the yellow LED on the function module is off.      | Short circuit/open circuit                         | Check the PROFIBUS wiring.  |
|  | The bus terminator is not activated.               | Activate the bus terminating resistor of the last bus device.   |
|  | Set station address is incorrect.                  | Set the correct station address.  |
| The PROFIBUS master indicates a bus error and the yellow LED on the function module is blinking. | Incorrect PROFIBUS configuration data              | Check the configuration data sent by the master via <b>C1526</b> .<br>Permitted configuration data:<br>☐ 39                   |
| The drive cannot be enabled.   | The enable signal via the control word is missing. | Send 007F <sub>hex</sub> .  |
|  | Controller inhibit via terminal is active.         | Set terminal X3/28 = HIGH (+12 ... +30 V).  |
|  | There is no setpoint selected.                     | <b>C0412/1</b> = 200 (setpoint source PROFIBUS) must be set<br>Assign a setpoint to the process output data in <b>C1511</b> . |

## 10 Codes

### 10.1 Overview

| Code  | Subcode | Index                                     | Designation  | See  |
|-------|---------|---|--|--|
| C0002 | -       | 24573 <sub>d</sub> =<br>5FFD <sub>h</sub> | Parameter set management                               |  84   |
| C0126 | -       | 24449 <sub>d</sub> =<br>5F81 <sub>h</sub> | Behaviour with communication error                     |  75   |
| C1500 | -       | 23075 <sub>d</sub> =<br>5A23 <sub>h</sub> | Software identification code                           |  77   |
| C1501 | -       | 23074 <sub>d</sub> =<br>5A22 <sub>h</sub> | Software creation date                                 |  77   |
| C1502 | 1 ... 4 | 23073 <sub>d</sub> =<br>5A21 <sub>h</sub> | Display of software identification code                |  77   |
| C1503 | 1 ... 4 | 23072 <sub>d</sub> =<br>5A20 <sub>h</sub> | Display of software creation date                      |  77   |
| C1509 | -       | 23066 <sub>d</sub> =<br>5A1A <sub>h</sub> | Setting the station address                            |  71   |
| C1510 | -       | 23065 <sub>d</sub> =<br>5A19 <sub>h</sub> | Configuration of process input data                    |  72   |
| C1511 | -       | 23064 <sub>d</sub> =<br>5A18 <sub>h</sub> | Configuration of process output data                   |  73   |
| C1512 | -       | 23063 <sub>d</sub> =<br>5A17 <sub>h</sub> | Enable process output data                             |  74 |
| C1513 | -       | 23062 <sub>d</sub> =<br>5A16 <sub>h</sub> | Monitoring response time of PZD communication          |  76 |
| C1514 | -       | 23061 <sub>d</sub> =<br>5A15 <sub>h</sub> | Monitoring reaction in case of PZD communication fault |  76 |
| C1516 | -       | 23059 <sub>d</sub> =<br>5A13 <sub>h</sub> | Display of baud rate                                   |  78 |
| C1517 | -       | 23058 <sub>d</sub> =<br>5A12 <sub>h</sub> | Display of station address                             |  78 |
| C1520 | 1...10  | 23055 <sub>d</sub> =<br>5A0F <sub>h</sub> | Display of all words to master                         |  79 |
| C1521 | 1...10  | 23054 <sub>d</sub> =<br>5A0E <sub>h</sub> | Display of all words from master                       |  79 |
| C1522 | 1...16  | 23053 <sub>d</sub> =<br>5A0D <sub>h</sub> | Display of all process data words to basic device      |  79 |
| C1523 | 1...16  | 23052 <sub>d</sub> =<br>5A0C <sub>h</sub> | Display of all process data words from basic device    |  80 |
| C1526 | 1...3   | 23049 <sub>d</sub> =<br>5A09 <sub>h</sub> | Display of last configuration data                     |  81 |
| C1530 | -       | 23045 <sub>d</sub> =<br>5A05 <sub>h</sub> | PROFIBUS-DP diagnostics                                |  82 |
| C1531 | 1 ... 4 | 23044 <sub>d</sub> =<br>5A04 <sub>h</sub> | Bus status   |  83 |

## How to read the code table

| Column                        | Meaning   |                               |   |               |
|-------------------------------|---|-------------------------------|---|---------------|
| Code                          | (Lenze) code <ul style="list-style-type: none"> <li>• The parameters of a configurable code marked with an asterisk (&lt;Code&gt;*) can only be accessed via the communication module.</li> <li>• The value of a configurable code marked with a double asterisk (&lt;Code&gt;** ) is not transmitted with the parameter set transfer.</li> </ul> |                               |   |               |
| Subcode                       | Subcode   |                               |   |               |
| Name                          | Designation of the Lenze code   |                               |   |               |
| Index                         | Index under which the parameter is addressed.   |                               |   |               |
| Lenze                         | Lenze setting of the code <table border="1" data-bbox="450 667 1442 725"> <tr> <td><input type="checkbox"/> Disp</td> <td>Display code<br/>Configuration of this code is not possible.</td> </tr> </table>  | <input type="checkbox"/> Disp | Display code<br>Configuration of this code is not possible. |               |
| <input type="checkbox"/> Disp | Display code<br>Configuration of this code is not possible.   |                               |   |               |
| Values                        | Fixed values determined by Lenze (selection list) <i>or</i> a value range: <table border="1" data-bbox="450 757 1442 788"> <tr> <td>Minimum value</td> <td>[Smallest increment/unit]</td> <td>Maximum value</td> </tr> </table>   | Minimum value                 | [Smallest increment/unit]                                   | Maximum value |
| Minimum value                 | [Smallest increment/unit]   | Maximum value                 |   |               |
| Access                        | R = read access (reading permitted)<br>W = write access (writing permitted)   |                               |   |               |
| Data type                     | <ul style="list-style-type: none"> <li>• FIX32: 32-bit value with sign; decimal with 4 decimal positions</li> <li>• U16: 2 bytes bit-coded</li> <li>• U32: 4 bytes bit-coded</li> <li>• VS: visible string, character string with defined length</li> </ul>   |                               |   |               |

## 10.2 Communication-relevant Lenze codes

### C1509: Bus device addressing

| Code  | Subcode | Index                                     | Possible settings |           |     | Data type    |
|-------|---------|---|-------------------|-----------|-----|--------------|
|       |         |   | Lenze             | Selection |     |              |
| C1509 |         | 23066 <sub>d</sub> =<br>5A1A <sub>h</sub> | 3                 | 3         | [1] | 126<br>FIX32 |

This code serves to set the bus device address. The setting in this code is only effective if the DIP switches **S1 ... S7** are set to OFF.



#### Note!

- ▶ The bus device addresses of networked controllers must differ from each other.
- ▶ Switch off the voltage supply of the function module and the controller, and then switch it on again to activate the changed settings.

### C1510: Configuration of process input data

| Code  | Subcode     | Index                                     | Possible settings |                 | Data type |
|-------|-------------|---|-------------------|-----------------|-----------|
|       |             |   | Lenze             | Selection       |           |
| C1510 |             | 23065 <sub>d</sub> =<br>5A19 <sub>h</sub> |                   |                 | FIX32     |
|       | 1 (PIW1)    |   | 18                | See table below |           |
|       | 2 (PIW2)    |   | 3                 |                 |           |
|       | 3 (PIW3)    |   | 4                 |                 |           |
|       | 4 (PIW 4)   |   | 5                 |                 |           |
|       | 5 (PIW 5)   |   | 6                 |                 |           |
|       | 6 (PIW 6)   |   | 7                 |                 |           |
|       | 7 (PIW 7)   |   | 8                 |                 |           |
|       | 8 (PIW 8)   |   | 9                 |                 |           |
|       | 9 (PIW 9)   |   | 10                |                 |           |
|       | 10 (PIW 10) |   | 11                |                 |           |

The bit status information or the actual values of the controller can be freely assigned to the max. 10 process data input words (PIW) of the master.



| Selection |   | Scaling  |
|-----------|---|--|
| 1         | FIF status word 1 (FIF-STAT1)                 | 16 bits  |
| 2         | FIF status word 2 (FIF-STAT2)                 | 16 bits  |
| 3         | Output frequency with slip (MCTRL1-NOUT+SLIP) | $\pm 24000 \approx \pm 480$ Hz   |
| 4         | Output frequency without slip (MCTRL1-NOUT)   | $\pm 24000 \approx \pm 480$ Hz   |
| 5         | Apparent motor current (MCTRL1-IMOT)          | $2^{14} \approx 100$ % rated device current  |
| 6         | Actual process controller value (PCTRL1-ACT)  | $\pm 24000 \approx \pm 480$ Hz   |
| 7         | Process controller setpoint (PCTRL1-SET)      | $\pm 24000 \approx \pm 480$ Hz   |
| 8         | Process controller output (PCTRL1-OUT)        | $\pm 24000 \approx \pm 480$ Hz   |
| 9         | Controller load (MCTRL1-MOUT)                 | $\pm 2^{14} \approx \pm 100$ % rated motor torque                                    |
| 10        | DC-bus voltage (MCTRL1-DCVOLT)                | 16383 $\approx$ 565 V DC for 400 V mains<br>16383 $\approx$ 325 V DC for 230 V mains |
| 11        | Ramp function generator input (NSET1-RFG1-IN) | $\pm 24000 \approx \pm 480$ Hz   |
| 12        | Ramp function generator output (NSET1-NOUT)   | $\pm 24000 \approx \pm 480$ Hz   |
| 13        | FIF-OUT.W1                                    | 16 bits or 0 ... 65535   |
| 14        | FIF-OUT.W2                                    | 16 bits or 0 ... 65535   |
| 15        | FIF-OUT.W3                                    | 0...65535  |
| 16        | FIF-OUT.W4                                    | 0...65535  |
| 17        | DRIVECOM control word (DRIVECOM-CTRL)         | 16 bits  |
| 18        | DRIVECOM status word (DRIVECOM-STAT)          | 16 bits  |



### C1511: Configuration of process output data

| Code  | Subcode     | Index                                     | Possible settings |                 | Data type |
|-------|-------------|---|-------------------|-----------------|-----------|
|       |             |   | Lenze             | Selection       |           |
| C1511 |             | 23064 <sub>d</sub> =<br>5A18 <sub>h</sub> |                   |                 | FIX32     |
|       | 1 (POW1)    |   | 17                | see table below |           |
|       | 2 (POW2)    |   | 3                 |                 |           |
|       | 3 (POW3)    |   | 4                 |                 |           |
|       | 4 (POW 4)   |   | 5                 |                 |           |
|       | 5 (POW 5)   |   | 6                 |                 |           |
|       | 6 (POW 6)   |   | 7                 |                 |           |
|       | 7 (POW 7)   |   | 8                 |                 |           |
|       | 8 (POW 8)   |   | 9                 |                 |           |
|       | 9 (POW 9)   |   | 10                |                 |           |
|       | 10 (POW 10) |   | 11                |                 |           |

The process data output words (POW) of the master can be freely assigned to bit control commands or setpoints of the controller via C1511.

| Selection |  | Scaling   |
|-----------|--|---|
| 1         | FIF control word 1 (FIF-CTRL1)                   | 16 bits   |
| 2         | FIF control word 2 (FIF-CTRL2)                   | 16 bits   |
| 3         | Setpoint 1 (NSET1-N1)                            | $\pm 24000 \equiv \pm 480$ Hz   |
| 4         | Setpoint 2 (NSET1-N2)                            | $\pm 24000 \equiv \pm 480$ Hz   |
| 5         | Additional setpoint (PCTRL1-NADD)                | $\pm 24000 \equiv \pm 480$ Hz   |
| 6         | Actual process controller value (PCTRL1-ACT)     | $\pm 24000 \equiv \pm 480$ Hz   |
| 7         | Process controller setpoint (PCTRL1-SET1)        | $\pm 24000 \equiv \pm 480$ Hz   |
| 8         | Reserved   |   |
| 9         | Torque setpoint/torque limit value (MCTRL1-MSET) | $2^{14} \equiv 100$ % rated motor torque  |
| 10        | PWM voltage (MCTRL1-VOLT-ADD)                    |    |
| 11        | PWM angle (MCTRL1-PHI-ADD)                       | For special applications only.<br> System manual for 8200 vector |
| 12        | Reserved   |   |
| 13        | FIF-IN.W1  | 16 bits or 0 ... 65535  |
| 14        | FIF-IN.W2  | 16 bits or 0 ... 65535  |
| 15        | FIF-IN.W3  | 0 ... 65535   |
| 16        | FIF-IN.W4  | 0 ... 65535   |
| 17        | DRIVECOM control word (DRIVECOM-CTRL)            | 16 bits   |

**C1512: Enable process output data**

| Code    | Subcode | Index                                     | Possible settings |           |       | Data type |
|---------|---------|---|-------------------|-----------|-------|-----------|
|         |         |   | Lenze             | Selection |       |           |
| C1512** |         | 23063 <sub>d</sub> =<br>5A17 <sub>h</sub> | 1                 | 1 [1]     | 65535 | FIX32     |

If code **C1511** is changed, the process output data are automatically inhibited to ensure data consistency.

Code **C1512** can be used to re-enable all or individual process data output words (POW).

Due to the different decimal values of the bit positions, any combination of process data output words can be enabled.

- ▶ 0 = Inhibit output word
- ▶ 1 = Enable output word

| Value of bit position |                |     |                |                |
|-----------------------|----------------|-----|----------------|----------------|
| POW 10                | POW 9          | ... | POW 2          | POW 1          |
| 2 <sup>9</sup>        | 2 <sup>8</sup> |     | 2 <sup>1</sup> | 2 <sup>0</sup> |

65535 (FFFF<sub>hex</sub>) in code **C1512** enables all process output data.

**Note!****8200 vector**

With 8200 vector it is not possible to enable individual process data output words. After mains switching this code is reset to 65535. Therefore, all process data are enabled.

**10.3 Monitoring codes**

**C0126: Behaviour with communication error**

| Code  | Subcode | Index             | Possible settings |  | Data type |       |
|-------|---------|-------------------|-------------------|--|-----------|-------|
|       |         |                   | Lenze             | Selection                                      |           |       |
| C0126 |         | 24449<br>(0x5F81) | 10                | 0  | [1] 10    | FIX32 |
|       |         |                   |                   | 0: All monitoring functions deactivated.       |           |       |
|       |         |                   |                   | 2: Monitoring of internal communication active |           |       |

Monitoring of internal communication between function module and controller.

If the monitoring function is activated, a communication abort initiates TRIP (CE5).



**Documentation for the standard device**

Please refer to this documentation for a complete description of the setting options of this code.

#### C1513: Monitoring response time of PZD communication

| Code  | Subcode | Index                                     | Possible settings |           |        | Data type   |
|-------|---------|---|-------------------|-----------|--------|-------------|
|       |         |   | Lenze             | Selection |        |             |
| C1513 |         | 23062 <sub>d</sub> =<br>5A16 <sub>h</sub> | 3000              | 0         | [1 ms] | 65535 FIX32 |

The value of the response monitoring time is provided by the master.



#### Note!

A change in the monitoring time becomes effective immediately. Monitoring starts with the receipt of the first telegram.

The setting **C1513 = 0** deactivates the monitoring function.

#### C1514: Monitoring reaction in case of PZD communication fault

| Code  | Subcode | Index                                     | Possible settings |                              |     | Data type |
|-------|---------|---|-------------------|------------------------------|-----|-----------|
|       |         |   | Lenze             | Selection                    |     |           |
| C1514 |         | 23061 <sub>d</sub> =<br>5A15 <sub>h</sub> | 0                 | 0                            | [1] | 3 FIX32   |
|       |         |   |                   | 0: no action                 |     |           |
|       |         |   |                   | 1: TRIP (fault)              |     |           |
|       |         |   |                   | 2: controller inhibit (CINH) |     |           |
|       |         |   |                   | 3: quick stop (QSP)          |     |           |

If the master does not send a message within the response monitoring time (configurable in **C1513**), the action set in this code is executed.



#### Note!

A change in the monitoring reaction becomes effective immediately.

## 10.4 Diagnostics codes

### C1500: Software identification code

| Code  | Subcode | Index             | Possible settings             |           | Data type |
|-------|---------|-------------------|-------------------------------|-----------|-----------|
|       |         |                   | Lenze                         | Selection |           |
| C1500 |         | 23075<br>(0x5A23) | <input type="checkbox"/> Disp |           | VS        |

Here the software identification code is displayed, e.g. "82ZAFU0B\_20000". The code contains a string with a length of 14 bytes.

### C1501: Software creation date

| Code  | Subcode | Index             | Possible settings             |           | Data type |
|-------|---------|-------------------|-------------------------------|-----------|-----------|
|       |         |                   | Lenze                         | Selection |           |
| C1501 |         | 23074<br>(0x5A22) | <input type="checkbox"/> Disp |           | VS        |

Here the software creation date and time are displayed, e.g. "Jun 21 2000 12:31". The code contains a string with a length of 17 bytes.

### C1502: Display of software identification code

| Code  | Subcode | Index             | Possible settings             |           | Data type |
|-------|---------|-------------------|-------------------------------|-----------|-----------|
|       |         |                   | Lenze                         | Selection |           |
| C1502 |         | 23073<br>(0x5A21) | <input type="checkbox"/> Disp |           | U32       |
|       | 1       |                   |                               |           |           |
|       | ...     |                   |                               |           |           |
|       | 4       |                   |                               |           |           |

Display of code **C1500** in 4 subcodes, 4 characters each.

### C1503: Display of software creation date

| Code  | Subcode | Index             | Possible settings             |           | Data type |
|-------|---------|-------------------|-------------------------------|-----------|-----------|
|       |         |                   | Lenze                         | Selection |           |
| C1503 |         | 23072<br>(0x5A20) | <input type="checkbox"/> Disp |           | U32       |
|       | 1       |                   |                               |           |           |
|       | ...     |                   |                               |           |           |
|       | 4       |                   |                               |           |           |

Display of code **C1501** in 4 subcodes, 4 characters each.

### C1516: Display baud rate

| Code  | Subcode | Index                                     | Possible settings             |               |     | Data type |       |
|-------|---------|---|-------------------------------|---------------|-----|-----------|-------|
|       |         |   | Lenze                         | Selection     |     |           |       |
| C1516 |         | 23059 <sub>d</sub> =<br>5A13 <sub>h</sub> | <input type="checkbox"/> Disp | 0             | [1] | 9         | FIX32 |
|       |         |   |                               | 0: 12 Mbps    |     |           |       |
|       |         |   |                               | 1: 6 Mbps     |     |           |       |
|       |         |   |                               | 2: 3 Mbps     |     |           |       |
|       |         |   |                               | 3: 1.5 Mbps   |     |           |       |
|       |         |   |                               | 4: 500 kbps   |     |           |       |
|       |         |   |                               | 5: 187.5 kbps |     |           |       |
|       |         |   |                               | 6: 93.75 kbps |     |           |       |
|       |         |   |                               | 7: 45.45 kbps |     |           |       |
|       |         |   |                               | 8: 19.2 kbps  |     |           |       |
|       |         |   |                               | 9: 9.6 kbps   |     |           |       |

### C1517: Display bus device address

| Code  | Subcode | Index                                     | Possible settings             |           |     | Data type |       |
|-------|---------|---|-------------------------------|-----------|-----|-----------|-------|
|       |         |   | Lenze                         | Selection |     |           |       |
| C1517 |         | 23058 <sub>d</sub> =<br>5A12 <sub>h</sub> | <input type="checkbox"/> Disp | 3         | [1] | 126       | FIX32 |

Display of the valid bus device address, which has been set via the DIP switches **S1 ... S7** or via code **C1509**.

### C1520: Display of all words to master

| Code  | Subcode    | Index                                     | Possible settings |           |     | Data type |
|-------|------------|---|-------------------|-----------|-----|-----------|
|       |            |   | Lenze             | Selection |     |           |
| C1520 |            | 23055 <sub>d</sub> =<br>5A0F <sub>h</sub> | Disp              | 0         | [1] | 65535     |
|       | 1 (PIW1)   |   |                   |           |     |           |
|       | ...        |   |                   |           |     |           |
|       | 10 (PIW10) |   |                   |           |     |           |

Display of the master's process data input words PIW1 ... PIW10 in the different subcodes. All words are displayed. Only the configured words are valid.

The assignment of the bit status information or the actual controller values to the up to 10 process data input words (PIW) of the master can be freely configured via code **C1510**.

### C1521: Display of all words from master

| Code  | Subcode    | Index                                     | Possible settings |           |     | Data type |
|-------|------------|---|-------------------|-----------|-----|-----------|
|       |            |   | Lenze             | Selection |     |           |
| C1521 |            | 23054 <sub>d</sub> =<br>5A0E <sub>h</sub> | Disp              | 0         | [1] | 65535     |
|       | 1 (POW1)   |   |                   |           |     |           |
|       | ...        |   |                   |           |     |           |
|       | 10 (POW10) |   |                   |           |     |           |

Display of the master's process data output words POW1 ... POW10 in the different subcodes. All words are displayed. Only the configured words are valid.

The assignment of the up to 10 process data output words (POW) of the master to bit control commands or controller setpoints can be freely configured via code **C1511**.

### C1522: Display of all process data words to standard device

| Code  | Subcode | Index                                     | Possible settings |           |     | Data type |
|-------|---------|---|-------------------|-----------|-----|-----------|
|       |         |   | Lenze             | Selection |     |           |
| C1522 |         | 23053 <sub>d</sub> =<br>5A0D <sub>h</sub> | Disp              | 0         | [1] | 65535     |
|       | 1       |   |                   |           |     |           |
|       | ...     |   |                   |           |     |           |
|       | 16      |   |                   |           |     |           |

Display of the process data words 1 ... 16 which are transferred from the function module to the standard device:

| Subcode | Process data word                                   |
|---------|---|
| 1       | FIF control word 1 (FIF-CTRL1)                      |
| 2       | FIF control word 2 (FIF-CTRL2)                      |
| 3       | Setpoint 1 (NSET1-N1)                               |
| 4       | Setpoint 2 (NSET1-N2)                               |
| 5       | Additional setpoint (PCTRL1-NADD)                   |
| 6       | Actual process controller value (PCTRL1-ACT)        |
| 7       | Process controller setpoint (PCTRL1-SET1)           |
| 8       | Reserved  |
| 9       | Torque setpoint or torque limit value (MCTRL1-MSET) |
| 10      | PWM voltage (MCTRL1-VOLT-ADD)                       |
| 11      | PWM angle (MCTRL1-PHI-ADD)                          |
| 12      | Reserved  |
| 13      | FIF-IN.W1   |
| 14      | FIF-IN.W2   |
| 15      | FIF-IN.W3   |
| 16      | FIF-IN.W4   |

### C1523: Display of all process data words from standard device

| Code  | Subcode | Index                                     | Possible settings             |           |     | Data type |     |
|-------|---------|---|-------------------------------|-----------|-----|-----------|-----|
|       |         |   | Lenze                         | Selection |     |           |     |
| C1523 |         | 23052 <sub>d</sub> =<br>5A0C <sub>h</sub> | <input type="checkbox"/> Disp | 0         | [1] | 65535     | U16 |
|       | 1       |   |                               |           |     |           |     |
|       | ...     |   |                               |           |     |           |     |
|       | 16      |   |                               |           |     |           |     |

Display of the process data words 1 ... 16 which are transferred from the standard device to the function module:

| Subcode | Process data word                              |
|---------|--|
| 1       | FIF status word 1 (FIF-STAT1)                  |
| 2       | FIF status word 2 (FIF-STAT2)                  |
| 3       | Output frequency with slip (MCTRL1-NOOUT+SLIP) |
| 4       | Output frequency without slip (MCTRL1-NOOUT)   |
| 5       | Apparent motor current (MCTRL1-IMOT)           |
| 6       | Actual process controller value (PCTRL1-ACT)   |
| 7       | Process controller setpoint (PCTRL1-SET)       |
| 8       | Process controller output (PCTRL1-OUT)         |
| 9       | Controller load (MCTRL1-MOUT)                  |
| 10      | DC-bus voltage (MCTRL1-DCVOLT)                 |
| 11      | Ramp function generator input (NSET1-RFG1-IN)  |
| 12      | Ramp function generator output (NSET1-NOOUT)   |
| 13      | FIF-OUT.W1                                     |
| 14      | FIF-OUT.W2                                     |
| 15      | FIF-OUT.W3                                     |
| 16      | FIF-OUT.W4                                     |



### C1526: Display of last configuration data

| Code  | Subcode   | Index                                     | Possible settings             |           |     | Data type |
|-------|-----------|---|-------------------------------|-----------|-----|-----------|
|       |           |   | Lenze                         | Selection |     |           |
| C1526 |           | 23049 <sub>d</sub> =<br>5A09 <sub>h</sub> | <input type="checkbox"/> Disp | 0         | [1] | 65535     |
|       | 1: byte 1 |   |                               |           |     |           |
|       | 2: byte 2 |   |                               |           |     |           |
|       | 3: byte 3 |   |                               |           |     |           |

This code displays the current configuration frame selected in the PROFIBUS master via the GSE file.

The configuration data indicate the following (see table below):

- ▶ The type of the set parameter data channel
- ▶ The length of the process data
- ▶ The existence/non-existence of process data consistency

| Consistent channel | + PZD ...    | Subcode                                    | Values   | Description   |
|--------------------|--------------|--|--|---|
| DRIVECOM-PAR(Cons) | PZD(1W)      | 1  | F3 <sub>hex</sub>  | With consistent DRIVECOM parameter data channel and process data  |
|                    |              | 2  | 70 <sub>hex</sub> ...<br>79 <sub>hex</sub>   | With consistent DRIVECOM parameter data channel and process data<br>Process data without consistency<br>70 <sub>hex</sub> : 1 word ... 79 <sub>hex</sub> : 10 words           |
|                    | PZD(1W Cons) | 1  | F3 <sub>hex</sub>  | With consistent DRIVECOM parameter data channel and consistent process data   |
|                    |              | 2  | F0 <sub>hex</sub> ...<br>F9 <sub>hex</sub>   | With consistent DRIVECOM parameter data channel and consistent process data<br>Process data with consistency<br>F0 <sub>hex</sub> : 1 word ... F9 <sub>hex</sub> : 10 words   |
| PKW(Cons)          | PZD(1W)      | 1  | 00 <sub>hex</sub>  | With consistent PROFIdrive parameter data channel and process data  |
|                    |              | 2  | F3 <sub>hex</sub>  | With consistent PROFIdrive parameter data channel and process data, in this case byte 1 is 00 <sub>hex</sub>  |
|                    |              | 3  | 70 <sub>hex</sub> ...<br>79 <sub>hex</sub>   | With consistent PROFIdrive parameter data channel and process data<br>Process data without consistency<br>70 <sub>hex</sub> : 1 word ... 79 <sub>hex</sub> : 10 words         |
|                    | PZD(1W Cons) | 1  | 00 <sub>hex</sub>  | With consistent PROFIdrive parameter data channel and consistent process data   |
|                    |              | 2  | F3 <sub>hex</sub>  | With consistent PROFIdrive parameter data channel and consistent process data, in this case byte 1 is 00 <sub>hex</sub>   |
|                    |              | 3  | F0 <sub>hex</sub> ...<br>F9 <sub>hex</sub>   | With consistent PROFIdrive parameter data channel and consistent process data<br>Process data with consistency<br>F0 <sub>hex</sub> : 1 word ... F9 <sub>hex</sub> : 10 words |
|                    | PZD(1W)      | 1  | 70 <sub>hex</sub> ...<br>79 <sub>hex</sub>   | Process data without consistency<br>70 <sub>hex</sub> : 1 word ... 79 <sub>hex</sub> : 10 words   |
| PZD(1W Cons)       |              | F0 <sub>hex</sub> ...<br>F9 <sub>hex</sub> | Process data with consistency<br>F0 <sub>hex</sub> : 1 word ... F9 <sub>hex</sub> : 10 words |   |



#### Tip!

Observe the descriptions concerning

- ▶ the user data length (📖 39)
- ▶ the meaning of consistency (📖 87)

**C1530: PROFIBUS diagnostics**

| Code  | Subcode | Index                                     | Possible settings             |           | Data type |
|-------|---------|---|-------------------------------|-----------|-----------|
|       |         |   | Lenze                         | Selection |           |
| C1530 |         | 23045 <sub>d</sub> =<br>5A05 <sub>h</sub> | <input type="checkbox"/> Disp | See below | FIX32     |

This code gives information on the current status of the PROFIBUS.

| Selection |  |   |   |   |        |
|-----------|--|---|---|---|--------|
| Bit       | Meaning  | Explanation   |   |   |        |
| 0         | Reserved                                       |   |   |   |        |
| 1         | Reserved                                       |   |   |   |        |
| 2         | Reserved                                       |   |   |   |        |
| 3         | Reserved                                       |   |   |   |        |
| 5/4       | State of the DP state machine (DP-STATE)       |   |   |   |        |
| 00        | WAIT_PRM                                       | The slave waits for a parameter data telegram after booting. Other types of telegrams will be rejected or will not be processed. Data exchange is not yet possible.                                   |   |   |        |
| 01        | WAIT_CFG                                       | The slave waits for the configuration telegram that specifies the number of input and output bytes. The master informs the slave about the number of input and output bytes that will be transferred. |   |   |        |
| 10        | DATA_EX  | If the parameter settings as well as the configuration have been accepted by the firmware and by the application, the slave state changes to "Data_Exchange" (exchange of user data with the master)  |   |   |        |
| 11        | Not possible                                   |   |   |   |        |
| 7/6       | State of the watchdog state machine (WD-STATE) |   |   |   |        |
| 00        | BAUD_SEARCH                                    | The Profibus slave is able to recognise the baud rate automatically.  |   |   |        |
| 01        | BAUD_CONTROL                                   | After recognising the correct baud rate, the slave state changes to "Baud_Control" and the transmission rate is monitored.  |   |   |        |
| 10        | DP_CONTROL                                     | This state is used for response monitoring of the PROFIBUS master.  |   |   |        |
| 11        | Not possible                                   |   |   |   |        |
| 8 ... 11  | PROFIBUS transmission rate recognised by SPC3  |   |   |   |        |
| Bit       | 11   | 10  | 9 | 8 | [kbps] |
|           | 0  | 0   | 0 | 0 | 12000  |
|           | 0  | 0   | 0 | 1 | 6000   |
|           | 0  | 0   | 1 | 0 | 3000   |
|           | 0  | 0   | 1 | 1 | 1500   |
|           | 0  | 1   | 0 | 0 | 500    |
|           | 0  | 1   | 0 | 1 | 187.5  |
|           | 0  | 1   | 1 | 0 | 93.75  |
|           | 0  | 1   | 1 | 1 | 45.45  |
|           | 1  | 0   | 0 | 0 | 19.2   |
|           | 1  | 0   | 0 | 1 | 9.6    |
| 12        | Reserved                                       |   |   |   |        |
| 13        | Reserved                                       |   |   |   |        |
| 14        | Reserved                                       |   |   |   |        |
| 15        | Reserved                                       |   |   |   |        |

**C1531: Bus counter**

| Code  | Subcode | Index                                     | Possible settings |           |     | Data type |
|-------|---------|---|-------------------|-----------|-----|-----------|
|       |         |   | Lenze             | Selection |     |           |
| C1531 |         | 23044 <sub>d</sub> =<br>5A04 <sub>h</sub> | Disp              | 0         | [1] | 65535     |
|       | 1       |   |                   |           |     |           |
|       | ...     |   |                   |           |     |           |
|       | 4       |   |                   |           |     |           |

Depending on the subcode, the following bus states are displayed:

- ▶ Subcode 1: data cycles per second
- ▶ Subcode 2: total data cycles
- ▶ Subcode 3: total parameterisation events
- ▶ Subcode 4: total configuration events



**Tip!**

When the maximum count value of 65535 is reached, the counter starts again with 0.

## 10.5 Important controller codes

## C0002: Parameter set management

(Extract from code table)

| Code  | Subcode | Index             | Possible settings |           | Data type |
|-------|---------|-------------------|-------------------|-----------|-----------|
|       |         |                   | Lenze             | Selection |           |
| C0002 |         | 24573<br>(0x5FFD) | 0                 | See below | FIX32     |

## ► Parameter set management:

| Selection | Description  |
|-----------|--|
| 0 Ready   | <b>PAR1 ... PAR4:</b> <ul style="list-style-type: none"> <li>Parameter sets of the controller</li> <li>PAR1 ... PAR4</li> </ul> <b>FPAR1:</b> <ul style="list-style-type: none"> <li>Module-specific parameter set of the function module</li> <li>FPAR1 is stored in the function module</li> </ul> |

## ► Restoring the delivery state:

| Selection                       | Description   |
|---------------------------------|---|
| 1 Lenze setting ⇔ PAR1          | Restoring the delivery state in the selected parameter set  |
| 2 Lenze setting ⇔ PAR2          |   |
| 3 Lenze setting ⇔ PAR3          |   |
| 4 Lenze setting ⇔ PAR4          |   |
| 31 Lenze setting ⇔ FPAR1        | Restoring the delivery state in the function module   |
| 61 Lenze setting ⇔ PAR1 + FPAR1 | Restoring the delivery state in the selected parameter set of the controller and in the function module |
| 62 Lenze setting ⇔ PAR2 + FPAR1 |   |
| 63 Lenze setting ⇔ PAR3 + FPAR1 |   |
| 64 Lenze setting ⇔ PAR4 + FPAR1 |   |

► Transferring parameter sets with the keypad:

| Selection  | Important   |   |
|--|---|---|
| You can use the keypad to transfer parameter sets to other controllers.<br>During the transfer, access to the parameters via other channels will be inhibited! |   |   |
| 70 Keypad ⇒ controller<br>10 With function module<br>10 (other)  | Overwrite all available parameter sets (PAR1 ... PAR4, FPAR1 if available) with the corresponding keypad data |   |
| 71 Keypad ⇒ PAR1 (+ FPAR1)<br>11 With function module<br>11 (other)  |   |   |
| 72 Keypad ⇒ PAR2 (+ FPAR1)<br>12 With function module<br>12 (other)  |   |   |
| 73 Keypad ⇒ PAR3 (+ FPAR1)<br>13 With function module<br>13 (other)  |   |   |
| 74 Keypad ⇒ PAR4 (+ FPAR1)<br>14 With function module<br>14 (other)  |   |   |
| 80 Controller ⇒ keypad<br>20 With function module<br>20 (other)  |   | Copy all available parameter sets (PAR1 ... PAR4, FPAR1 if available) into the keypad |
| 40 Keypad ⇒ function module<br>Only with function module   |   |   |
| 50 Function module ⇒ keypad<br>Only with function module   |   |   |

► Saving your own setting:

| Selection            | Important  |
|----------------------|--|
| 9 PAR1 ⇒ own setting | You can store your own setting for the controller parameters (e.g. the delivery state of your machine):<br>1. Check that parameter set 1 is active<br>2. Inhibit the controller<br>3. Set C0003 = 3, confirm with <b>ENTER</b><br>4. Set C0002 = 9, confirm with <b>ENTER</b> , your own setting has been stored<br>5. Set C0003 = 1, confirm with <b>ENTER</b><br>6. Enable the controller<br><br>This function can also be used to copy PAR1 to the parameter sets PAR2 ... PAR4 |
| 5 Own setting ⇒ PAR1 |  |
| 6 Own setting ⇒ PAR2 | Restore your own setting in the selected parameter set   |
| 7 Own setting ⇒ PAR3 |  |
| 8 Own setting ⇒ PAR4 |  |

## Use of function module in conjunction with starttec motor starter

**Note!**

If the function module is used in conjunction with the starttec motor starter, solely the Lenze device control is effective.

In the following table, the bit assignments for the applicable control word 1 (FIF-CTRL1) and status word 1 (FIF-STAT1) are given:

| Control word 1 (FIF-CTRL1) |  | Status word 1 (FIF-STAT1) |                                 |
|----------------------------|--|---------------------------|---------------------------------|
| Bit                        | Assignment   | Bit                       | Assignment                      |
| 0                          | S1   | 0                         | Reserved                        |
| 1                          | S2   | 1                         | Reserved                        |
| 2                          | Brake  | 2                         | Reserved                        |
| 3                          | Reserved   | 3                         | Reserved                        |
| 4                          | Reserved   | 4                         | Reserved                        |
| 5                          | Reserved   | 5                         | Reserved                        |
| 6                          | Reserved   | 6                         | Fixed 1                         |
| 7                          | Reserved   | 7                         | Controller inhibit              |
|                            |  | 0                         | Controller enabled              |
|                            |  | 1                         | Controller inhibited            |
| 8                          | Reserved   | 8 ... 11                  | Device status                   |
| 9                          | Controller inhibit (FIF-CTRL1-CINH)                    |                           |                                 |
| 0                          | Controller enabled                                     |                           |                                 |
| 1                          | Controller inhibited                                   |                           |                                 |
| 10                         | External fault (FIF-CTRL1-TRIP-SET)                    |                           |                                 |
| 11                         | Fault reset  |                           |                                 |
| 0=>1                       | (FIF-CRTL1-TRIP-RESET)<br>Bit change causes TRIP reset |                           |                                 |
| 12                         | Reserved   | 12                        | Reserved                        |
| 13                         | Reserved   | 13                        | Reserved                        |
| 14                         | Reserved   | 14                        | Reserved                        |
| 15                         | Reserved   | 15                        | Ready for operation             |
|                            |  | 0                         | Not ready for operation (fault) |
|                            |  | 1                         | Ready for operation (no fault)  |

| Bit | 11 | 10 | 9 | 8 |  |
|-----|----|----|---|---|--|
|     | 0  | 0  | 1 | 1 | Operation inhibited                          |
|     | 0  | 1  | 1 | 0 | Operation enabled                            |
|     | 1  | 0  | 0 | 0 | Fault active                                 |
|     | 1  | 1  | 1 | 1 | Communication with basic device not possible |

## 11.2 Consistent parameter data

In the PROFIBUS communication system, data are permanently exchanged between the host (**CPU + PROFIBUS master**) and the standard device via the plugged-on slave interface module.

Both the PROFIBUS master and the CPU (central processing unit) of the host access a joint memory - the dual port memory (DPM).

The DPM allows data exchange in both directions (write/read):

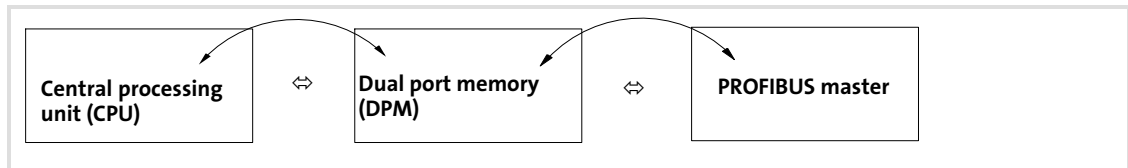

It could happen that a slower PROFIBUS master writing would be overtaken by a faster CPU reading within a cycle time without any further data organisation.

To avoid such an impermissible state, the parameter data to be transmitted must be marked as "consistent".

### Data communication with existing consistency

With consistency, either "reading" or "writing" is possible when the master and the CPU simultaneously access the memory:

- ▶ The PROFIBUS master transfers data only as a complete data set.
- ▶ The CPU can only access completely updated data sets.
- ▶ The PROFIBUS master cannot read or write data as long as the CPU accesses consistent data.

The result becomes clear from the example below:

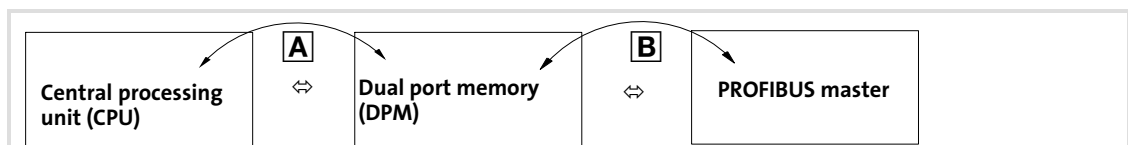

- A CPU wants to read!
- B PROFIBUS master wants to write simultaneously!
  1. As the PROFIBUS master can only write if the CPU does not read, the master has to wait until the data are read completely by the CPU.
  2. The PROFIBUS master only writes a complete data set into the DPM.

**Configuring consistent data**

Consistency is achieved by an appropriate PROFIBUS master configuration. Please refer to the corresponding documentation for your configuring software for this purpose.

**Tip!**

Consistency configuration depends on the PROFIBUS master configuring software. When using a Siemens-S5 PLC, please consider:

- ▶ Consistency is switched on by any word in the consistent area
- ▶ Consistency must be switched off by a specific switch-off word.
- ▶ The type of CPU and consistency and the address area determine which word switches off consistency.



## 11.3 Parallel operation of AIF and FIF interfaces

**Note!**

The option of parallel operation ...

- ▶ of a communication module (AIF) and a function module (FIF) exists for the standard devices 8200 vector and Drive PLC.
- ▶ of two function modules (FIF) exists for the standard devices 8200 motec, Drive PLC and starttec.

**Possible combinations**

| Function module on FIF |             | Communication module on AIF             |                          |   |                      |                        |                                    |
|------------------------|-------------|---|--------------------------|---|----------------------|------------------------|------------------------------------|
|                        |             | Keypad E82ZBC<br>Keypad XT<br>EMZ9371BC | PROFIBUS-DP<br>EMF2133IB | System bus<br>CAN<br>EMF2171IB<br>EMF2172IB | CANopen<br>EMF2178IB | DeviceNet<br>EMF2179IB | Ethernet<br>PowerLink<br>EMF2191IB |
| Standard I/O PT        | E82ZAFSC010 | ✓                                       | ✓                        | ✓   | ✓                    | ✓                      | ✓                                  |
| Application I/O PT     | E82ZAFAC010 | ✓                                       | ✓)                       | ✓)  | ✓)                   | ✓)                     | ✓)                                 |
| PROFIBUS-DP            | E82ZAFPC010 | ✓                                       | ☒                        | ☒   | ☒                    | ☒                      | ☒                                  |
| PROFIBUS I/O           | E82ZAFPC201 |   |                          |   |                      |                        |                                    |
| Sys. bus CAN PT        | E82ZAFCC010 |   |                          |   |                      |                        |                                    |
| Sys. bus CAN PT        | E82ZAFCC210 | ✓                                       | ✓                        | ✓   | ✓                    | ✓                      | ✓                                  |
| Sys.-bus CAN-I/O RS PT | E82ZAFCC100 |   |                          |   |                      |                        |                                    |
| CANopen PT             | E82ZAFUC010 | ✓                                       | ☒                        | ☒   | ☒                    | ☒                      | ☒                                  |
| DeviceNet PT           | E82ZAFVC010 | ✓                                       | ☒                        | ☒   | ☒                    | ☒                      | ☒                                  |
| INTERBUS PT            | E82ZAFIC010 | ✓                                       | ☒                        | ☒   | ☒                    | ☒                      | ☒                                  |
| LECOM-B PT             | E82ZAFLC010 | ✓                                       | ☒                        | ☒   | ☒                    | ☒                      | ☒                                  |
| AS interface PT        | E82ZAFFC010 | ✓                                       | ☒                        | ☒   | ☒                    | ☒                      | ☒                                  |

| Function module on FIF |             | Communication module on AIF |                              |                            |                            |                             |
|------------------------|-------------|-----------------------------|------------------------------|----------------------------|----------------------------|-----------------------------|
|                        |             | INTERBUS<br>EMF2113IB       | LECOM-A/B<br>EMF2102IBC V001 | LECOM-A<br>EMF2102IBC V004 | LECOM-B<br>EMF2102IBC V002 | LECOM-LI<br>EMF2102IBC V003 |
| Standard I/O PT        | E82ZAFSC010 | ✓                           | ✓                            | ✓                          | ✓                          | ✓                           |
| Application I/O PT     | E82ZAFAC010 | ✓)                          | ✓)                           | ✓)                         | ✓)                         | ✓)                          |
| PROFIBUS-DP            | E82ZAFPC010 |                             |                              |                            |                            |                             |
| PROFIBUS I/O           | E82ZAFPC201 | ☒                           | ✓)                           | ✓                          | ✓)                         | ✓)                          |
| Sys. bus CAN PT        | E82ZAFCC010 |                             |                              |                            |                            |                             |
| Sys. bus CAN PT        | E82ZAFCC210 | ✓                           | ✓                            | ✓                          | ✓                          | ✓                           |
| Sys.-bus CAN-I/O RS PT | E82ZAFCC100 |                             |                              |                            |                            |                             |
| CANopen PT             | E82ZAFUC010 | ☒                           | ✓)                           | ✓                          | ✓)                         | ✓)                          |
| DeviceNet PT           | E82ZAFVC010 | ☒                           | ✓)                           | ✓                          | ✓)                         | ✓)                          |
| INTERBUS PT            | E82ZAFIC010 | ☒                           | ✓)                           | ✓                          | ✓)                         | ✓)                          |
| LECOM-B PT             | E82ZAFLC010 | ☒                           | ✓)                           | ✓                          | ✓)                         | ✓)                          |
| AS interface PT        | E82ZAFFC010 | ☒                           | ✓)                           | ✓                          | ✓)                         | ✓)                          |

- ✓ Combination possible, communication module can be supplied internally or externally (keypad only internally)
- ✓ Combination possible, communication module has to be supplied externally
- ☒ Combination not possible

**Notes on parallel operation**

For internal voltage supply, the jumper **A** must be plugged on at the indicated position.

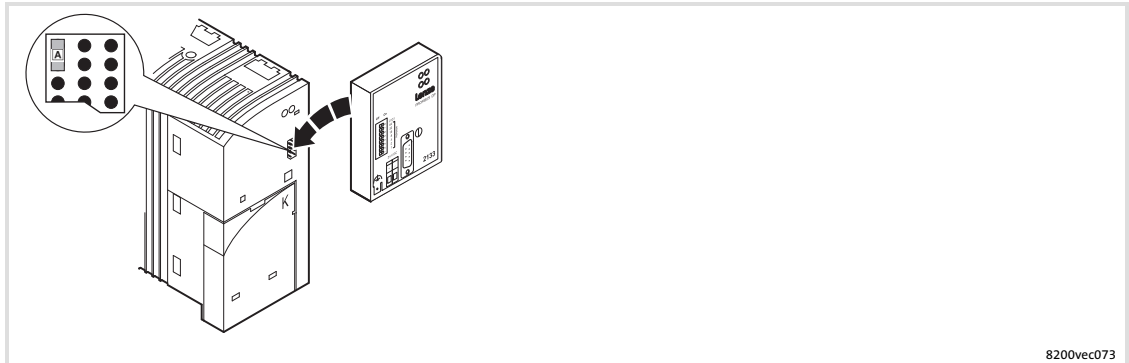

| External voltage supply (delivery state) | Voltage supply through internal voltage source |
|--|--|
|  |  |

## 12 Index

### A

Access to Lenze codes, DRIVECOM, 57

Adapting device controls, 38

Address settings, 41

Addressing

- Lenze parameters (DRIVECOM), 57

- parameter data (DRIVECOM), 57

- Parameter sets, 66

Ambient conditions, 15

- Climate, 15

Application as directed, 11

### B

Baud rate, 15

Bus cable length, 24 , 32

### C

C0002: Parameter set management, 84

C0126: Behaviour with communication error, 75

C1500: Software identification code, 77

C1501: Software creation date, 77

C1502: Display of software identification code, 77

C1503: Display of software creation date, 77

C1509: Bus device addressing, 71

C1510: Configuration of process input data, 48 , 72

C1511: Configuration of process output data, 45 , 73

C1512: Enable process output data, 74

C1513: Monitoring response time of PZD communication, 76

C1514: Monitoring reaction in case of PZD communication fault, 76

C1516: Display baud rate, 78

C1517: Display bus device address, 78

C1520: Display of all words to master, 79

C1521: Display of all words from master, 79

C1522: Display of all process data words to standard device, 79

C1523: Display of all process data words from standard device, 80

C1526: Display of last configuration data, 81

C1530: PROFIBUS diagnostics, 82

C1531: Bus counter, 83

Cable cross-sections, 30

Cable specification, 24

CE-typical drive system, 21

Codes, 69

Commissioning, 33

Commissioning steps, 34

Communication medium, 15

Communication profile, 15

Communication time, 18

Communication-relevant Lenze codes, 71

Configuration

- Process input data, 48

- Process output data, 44

Connections, 14

Consistent parameter data, 87

Control, DRIVECOM, 51

Controller codes, 84

### D

Defining the user data length, 39

Definition of notes used, 8

Definitions, 7

Device control, Lenze, 44

Device data base file, 37

Device protection, 10 , 20

DeviceNet, Bus cable length, 32

Diagnostics, 67

Diagnostics codes, 77

DIP switch, 14

DP user data length, 15

Drive profile, 15

DRIVECOM

- Bit control commands, 54

- Control word, 52

- error codes, 61

- Parameter data channel, 57

- State machine, 51

- Status bits, 55

- Status word, 53

DRIVECOM control, 51

## E

### **E82ZAFPC00x**

- external supply, 17
- load on ext. supply, 17

### **E82ZAFPC010**

- external supply, 17
- load on ext. supply, 17

### **E82ZAFUC010**

- rated data, 16
- terminal assignment, 29

### **Electrical installation, 21**

### **Error codes, DRIVECOM, 61**

### **External supply**

- E82ZAFPC00x, 17
- E82ZAFPC010, 17

### **External voltage supply, 26**

## F

### **Fault elimination, 68**

### **Features of the function module, 13**

## I

### **Identification, 12**

### **Installation, 20**

- electrical, 21
- mechanical, 20
- Terminals, Assignment, 28

### **Insulation**

- E82ZAFPC001, 16
- E82ZAFUC010, 16

### **Insulation voltage, 16**

### **Interfaces, 14**

### **Internal DC voltage supply, 25**

## L

### **LED status displays, 67**

### **Lenze codes, 69**

- C0002, 84
- C0126, 75
- C1500, 77
- C1501, 77
- C1502, 77
- C1503, 77
- C1509, 71
- C1510, 48, 72
- C1511, 45, 73
- C1512, 74
- C1513, 76
- C1514, 76
- C1516, 78
- C1517, 78
- C1520, 79
- C1521, 79
- C1522, 79
- C1523, 80
- C1526, 81
- C1530, 82
- C1531, 83

### **Lenze parameters, DRIVECOM, 57**

## M

### **Master, Settings, 36**

### **Mechanical installation, 20**

### **Monitoring, Codes, 75**

## N

### **Nameplate, 12, 14**

### **Nameplate data, 12**

### **Network topology, 15**

### **Notes, definition, 8**

### **Number of bus devices, 23**

## O

### **Order designation, 15**

## P

### **Parallel operation of AIF and FIF interfaces, 89**

### **Parameter, C0142 (protection against unexpected start-up), 42**

### **Parameter data, Consistency, 87**

**Parameter data channel, DRIVECOM, 57**

- addressing of the parameter data, 57
- Lenze parameters (DRIVECOM), 57
- telegram structure, 57

**Parameter data transfer, 56****Parameter set management, 84****Parameter set transfer, 66****Parameter sets, Lenze, 66****Plug connectors, 31**

- Use, spring connection, 31

**Pollution, 15****Process data transfer, 43****Process input data configuration, 48****Process output data configuration, 44****Processing time, 18****Processing times**

- 8200 motec, 18
- 8200 vector, 18
- starttec, 18

**Product description, 11**

- application as directed, 11

**Product features, 13****PROFIdrive**

- Reading parameters (DP-V0), 62
- Writing parameters (DP-V0), 64

**Protection against uncontrolled start-up, 42****Protection against unexpected start-up, 42****Protection of persons, 10****Protective insulation, 16**

- E82ZAFPC001, 16

**PUO ID number, 15****R****Rated data, 16****Reading parameters, PROFIdrive (DP-V0), 62****Repeaters, 23****Residual hazards, 10****S****Safety instructions, 9**

- application as directed, 11
- definition, 8
- device- and application-specific, 10
- layout, 8

**Screw-tightening torques, 30****Setting the node address, 41****Settings, Master, 36****Specification of the transmission cable, 24****Status displays, 67****T****Technical data, 15****Telegram structure, DRIVECOM, 57****Terminal assignment, E82ZAFUC010, 29****Terminal strip, connections, 14****Terminals, Assignment, 28****Transmission cable, specification, 24****Troubleshooting, 68****Type code, 12**

- finding, 12

**U****Usage conditions, Ambient conditions, Climate, 15****Use of plug connectors, 31****V****Validity of the documentation, 5****Voltage supply, 25**

- internal, 25

**Voltage supply: external, 26****W****Wiring according to EMC, 21****Wiring with a host (master), 22****Writing parameters, PROFIdrive (DP-V0), 64**



© 03/2012



Lenze Drives GmbH  
Postfach 10 13 52  
D-31763 Hameln  
Germany



+49 (0)51 54 / 82-0



+49 (0)51 54 / 82-28 00



Lenze@Lenze.de



www.Lenze.com

Service

Lenze Service GmbH  
Breslauer Straße 3  
D-32699 Extertal  
Germany



00 80 00 / 24 4 68 77 (24 h helpline)



+49 (0)51 54 / 82-11 12



Service@Lenze.de

EDS82ZAFPC010 ■ 13403741 ■ EN ■ 4.0 ■ TD29

10 9 8 7 6 5 4 3 2 1